

# **Kubla Cubed User Manual**

## **Version 6.3**



# Contents

<b>Chapter 1: Introduction.....</b>	<b>7</b>
Kubla Software.....	8
Kubla Cubed.....	8
<b>Chapter 2: Getting Started.....</b>	<b>9</b>
User Interface.....	10
Setting the Correct Units.....	11
Cursor Label.....	12
Navigation.....	12
Construction Phases.....	15
<b>Chapter 3: Display.....</b>	<b>17</b>
Changing Background Color.....	18
Display Panel.....	18
Lighting.....	19
Line Work.....	19
Earthworks Shading.....	19
On-Screen Statistics.....	20
Single Camera Mode.....	21
Presentation Mode.....	21
Colour Keys.....	21
Vertical Exaggeration.....	23
<b>Chapter 4: Site Plans.....</b>	<b>25</b>
Overview.....	26
Quick Measure Tool.....	26
Editing Modes.....	27
Adding a Site Plan.....	27
Setting the Position and Cropping.....	28
Setting the Transparency.....	31
<b>Chapter 5: Elevation Elements.....</b>	<b>33</b>
The Elements Panel.....	34
Calculation Order.....	37
Relative Elements.....	38
Reduce Element.....	39
Raise Element.....	39
Trench Element.....	40
Berm Element.....	41
Absolute Elements.....	42
Platform Element.....	42
Slope Element.....	43
Path Element.....	45
Feature Surface Element.....	46
Triangle Surface Element.....	47

<b>Chapter 6: Measurement Elements.....</b>	<b>49</b>
The Measurements Panel.....	50
Count Element.....	52
Length Element.....	52
Area Element.....	53
Volume Region Element.....	54
Cross Section Element.....	54
<b>Chapter 7: Editing Elements.....</b>	<b>57</b>
Feature Types.....	58
Adding New Features.....	59
Adding Features Manually.....	60
Adding Features from a PDF/CAD File.....	62
Adding Points from a Data File.....	63
Editing and Deleting Features.....	65
Triangle Surface.....	66
Editing Tools.....	67
Set Multiple Elevation (SME) Tool.....	68
Offset Tool.....	69
Split Tool.....	70
Join Tool.....	71
<b>Chapter 8: Defining Existing Ground.....</b>	<b>73</b>
Existing Defined with Points, Contour Lines and Break-Lines.....	74
Existing Defined with Triangles.....	76
Existing Boundary Outline.....	76
Lidar and Photogrammetry data.....	77
<b>Chapter 9: Topsoil Stripping.....</b>	<b>79</b>
Reducing a Topsoil Strip by Specified Depths.....	80
Excluding Internal Areas from a Strip.....	81
<b>Chapter 10: Demolition.....</b>	<b>83</b>
Breaking Out Concrete Areas.....	84
Milling Paved Areas.....	84
Calculating the Volume of Demolished Materials.....	85
<b>Chapter 11: Bulk Earthworks.....</b>	<b>87</b>
Bulk Earthworks - Overview.....	88
Adjusting to Subgrade / Formation Level.....	88
Soft Landscape (Ponds, Gardens, External Works, etc.).....	90
Hard Landscape (Building Pads, Drives, Car Parks, etc.).....	91
Recreational Grounds (Golf Course, Sports Pitch, etc.).....	92
Roads and Paths.....	92
Retaining Walls.....	94
<b>Chapter 12: Utility Trenches.....</b>	<b>97</b>

<b>Chapter 13: Foundations.....</b>	<b>99</b>
Modelling Foundations.....	100
Backfilling.....	100
Filling Around Structural Elements.....	101
<b>Chapter 14: Paving, Turf and Sod.....</b>	<b>103</b>
Using Reported Areas to Calculate Paving Volumes.....	104
Using the Raise Element to Report Paving Volumes.....	105
Obtaining a Breakdown of different Paving Strata.....	106
<b>Chapter 15: Marine Dredging &amp; Reclamation.....</b>	<b>107</b>
Coordinates and Bathymetry.....	108
Modelling tools.....	108
Visualisation.....	109
<b>Chapter 16: Stockpile Volumes.....</b>	<b>111</b>
Importing Survey Point File (.CSV, .XYZ, .XLS, UAV).....	112
Calculate the Volume of the Stockpile.....	112
<b>Chapter 17: Exporting Spreadsheets &amp; Reports.....</b>	<b>115</b>
Creating Reports.....	116
Creating Spreadsheets.....	117
<b>Chapter 18: Exporting Images &amp; Drawings.....</b>	<b>119</b>
Creating Drawings.....	120
Export Image.....	121
Export to LandXML.....	123
<b>Chapter 19: Export to CAD.....</b>	<b>125</b>
CAD Export Options.....	126
<b>Chapter 20: Export to BIM and/or Machine Control.....</b>	<b>129</b>
Exporting for BIM Software.....	130
Exporting for Machine Control Systems.....	130
<b>Chapter 21: Troubleshooting.....</b>	<b>133</b>
Essential Project Checks.....	134
Error Messages in Kubla Cubed.....	134



---

# Chapter 1

---

## Introduction

---

### Topics:

- [Kubla Software](#)
- [Kubla Cubed](#)

Welcome to the Kubla Cubed user guide. Kubla Cubed is a general purpose volumetric calculation tool. It uses a cutting edge TIN based volumetric calculation engine to estimate cut & fill in a diverse range of scenarios. Innovative and powerful design tools are available to complete volume estimates for: site stripping, bulk earthworks, building pads, ponds, roads, retaining walls, stockpiles, marine dredging and many other scenarios. Whether you are doing complicated take-off from PDF drawings or comparing two surveys, Kubla Cubed has all the tools you need to get the job done.

## **Kubla Software**

---

Kubla Ltd is an engineering software company formed in 2013. We are headquartered in Bristol (UK) the home of Britain's most famous engineering accomplishments Clifton suspension bridge and iron hulled vessel SS Great Britain, both engineered by the celebrated Engineer Isambard Kingdom Brunel.

We are an innovative software company, focussed on creating applications for engineering, surveying and construction professionals. Our solutions are used globally, on projects ranging from the design of dredging works, to the everyday production of accurate earthworks bids.

Our software products are developed in-house, by specialists in engineering, surveying and graphical visualisation. We pride ourselves on developing bespoke and off-the-shelf solutions which are both cutting-edge and extremely easy to use. By focussing on software design and support we help our users to concentrate on engineering problems through software solutions.

## **Kubla Cubed**

---

*Kubla Cubed* provides a range of tools for recording earthwork data and measuring the results. Data can be input manually, from Vector data in PDFs and from CAD. There are a number of export options which can be used to export designs into a CAD or LandXML files or produce images, reports and spreadsheets for project documentation.



---

# Chapter

# 2

---

## Getting Started

---

### Topics:

- [User Interface](#)
- [Setting the Correct Units](#)
- [Cursor Label](#)
- [Navigation](#)
- [Construction Phases](#)

In this section, you will discover the different parts of the application and how to interact with them.

## User Interface

The quickest way to get started with *Kubla Cubed* is to open an example file. If you click on File and then Open you will see a list of example files which you can start with. Once you have opened a file the window will appear as shown below:

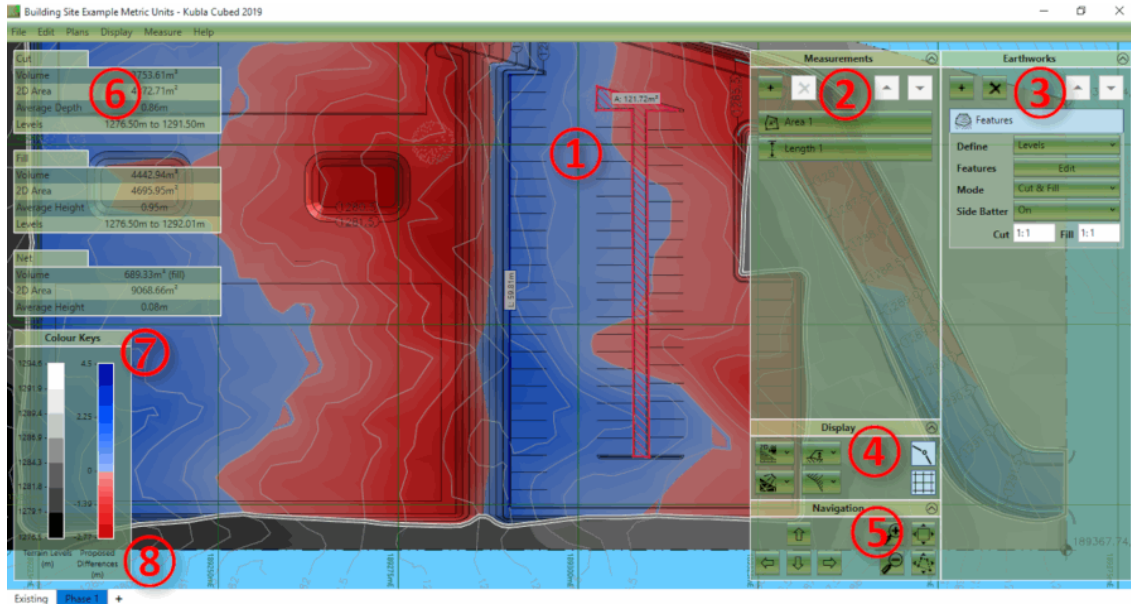

The different elements of this user interface are briefly described below:

- ① Design Area - This is the main display where the existing ground and the proposed earthworks will be displayed.
- ② Measurements Panel - This panel is used for adding, removing and editing the measurement elements (e.g lengths, areas, counts).
- ③ Earthworks Panel - This panel is used for adding, removing and editing the earthworks elements, which are combined together to create a proposed surface.
- ④ Display Panel - This panel is used for changing various display options (e.g camera controls, lighting and grid lines).
- ⑤ Navigation Panel - The controls in this panel can be used for zooming, panning and rotating (in 3D) the views.
- ⑥ The Results Panel - The results panel shows an overview of the earthworks estimation for the current phase. A more detailed analysis can be produced in a report or spreadsheet.
- ⑦ The Colour Keys These colour keys show the shading which is used to display the existing and proposed topography.
- ⑧ Construction Phases The bottom of the first tab shows the existing ground; subsequent tabs show phases of proposed earthworks.

When you are ready to start your own project the first step is to add your site plans, do this by selecting 'Add Image \PDF File' from the Plans menu (you can skip this step if working exclusively with CAD or XYZ point files). To start defining existing elevations make sure the Existing tab is selected and then in the Ground panel on the right-hand side click on the + symbol and add a Feature Surface or a Triangle Surface.

This will open a window which will allow you to define existing ground elevations or import a triangulated mesh from a file. Once you have done this you can create and edit proposed earthworks by selecting the Proposed 1 tab and adding earthworks elements such as platforms, slopes, strips or another feature surface.



Learn about Kubla Cubed site plans in our video [Site Plans - Overview](#). Then become familiar with tools that generate earthwork estimations in the video [Proposed Levels - Overview](#). Dive into an example project in our [walk-through videos](#) (available on the website). Our website also has stand-alone [video tutorials](#)

## Setting the Correct Units

*Kubla Cubed* can display either metric or imperial (English) units. These will initially be set to a default value depending on the region settings of the computer. The initial settings can easily be changed by clicking Measure in the menu bar and then Display Units.

	Units	Precision	Preview
Volumes	Cubic feet	2	581,222.20ft <sup>3</sup>
Areas	Square feet	2	166,372.06ft <sup>2</sup>
Positions and Lengths	Feet	2	5,399,141.71ftE; 1,298,637.09ftN; 293.09ft
Short Lengths and Thicknesses	Inches	1	9.8in

① Units For each measurement type (volumes, areas, positions and short lengths) you can select the desired unit of measure. It is recommended that you do not mix imperial and metric units together. For instance if areas and volumes are set to yards, then positions should be set to feet.

② Precision For each measurement type you can also change the precision displayed in the program. It should be noted that this has no effect on the calculation engine precision just the display. The default is two decimal places which is sufficient for most earthworks projects.

**Notes on Sharing Files :** All Kubla files are saved with the same units internally. The display settings that can be changed in Kubla Cubed only affect the way the units are displayed to the user. They do not change how the units are saved internally. This means if you share a file with another user, the file will display correctly in whatever units they have selected as their preference. This can cause complications if a site plan is marked in different units to what the user has selected, however if this happens it is simple to synchronise the display units to match those marked on the site plan using the above options.



Application settings (not project settings) are shown in our video [Getting Started - Units and Display Settings](#)

## Cursor Label

As the mouse is moved around, a label containing data about the position underneath the cursor, can be displayed (updates in real time). X and Y co-ordinates, existing\proposed elevations and cut\fill values can be displayed. The label options can be customised to show only the information you require.

In the design area of a project a label displays information about the point on the surface underneath the cursor (e.g. X:41.23mE, Y:23.43mN, Zp:12.34m). Using the settings menu, you can customise what is displayed next to the cursor. As well as showing the co-ordinates you can also choose to include the existing level (Ze), proposed level (Zp) and the cut\fill (C\F). To access the cursor options first click on the Settings menu bar and then select Cursor. Here the different available items that can be displayed in the cursor label can be turned on\off.

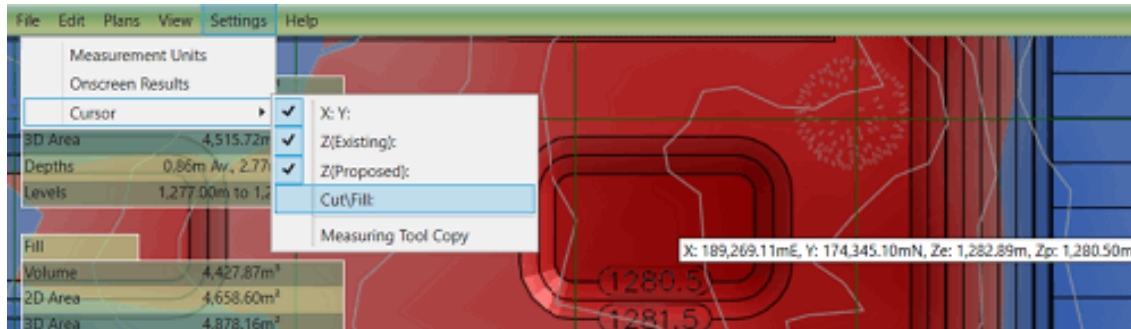

**Notes on Copying the Label Contents :** Sometimes there is a requirement to copy the contents of the cursor label. Of course you can simply copy it down by hand but that can be time consuming and lead to mistakes. To copy the contents of the cursor label to the clipboard make sure that Measure Tool Copy is ticked in the cursor menu. Then simply tap the M key. This will activate the quick measure tool and copy the contents to the clipboard. After copying go to a document or spreadsheet and paste either using the Edit menu of the program or using the universal Ctrl+V shortcut for pasting. For more information see [Quick Measure Tool](#) .



## Navigation

Navigation is done either using the mouse, the keyboard or the buttons on the navigation panel. The way the navigation works depends upon the camera you have selected for display.

You can choose whether you want to navigate through each phase independently, or whether to sync navigation between phases. The best option can depend on the situation. Where each phase is focussed on different parts of the site it may be easier to navigate independently, whereas if each phase is building up parts of the same area it can be easier to sync the navigation. To toggle this setting you can click on View and then Single Camera.





There are 3 different cameras that you can use to display and navigate as described below.

When you change the cameras the controls for navigation will also change. For more information see [Navigation](#)

	<p><b>Design View</b></p> <p>This option displays the project in plan view (2D) from above. You must be in this view to draw lines to create all design elements except for the surface.</p>
	<p><b>3d Orbit View</b></p> <p>This 3d view is used to orbit around the centre of the terrain, as well as to tilt the view up and down.</p>
	<p><b>3d Flyover View</b></p>

	This 3d view is used to fly over the existing terrain and allows the user to move forward and backward and rotate the view in all directions.
--	---





The following controls are the same regardless of the camera you have selected.

	<p><b>Zoom In</b></p> <p>Keyboard: '+' key</p> <p>Mouse: <i>Scroll Wheel Forwards</i></p>
	<p><b>Zoom Out</b></p> <p>Keyboard: '-' key</p> <p>Mouse: <i>Scroll Wheel Backwards</i></p>
	<p><b>Zoom to Extents</b></p> <p>This button zooms to frame all visible items.</p>
	<p><b>Zoom to Selection</b></p> <p>This button zooms to frame the selected element.</p>

The rest of navigation controls depend upon the camera you have selected.





#### Navigation in Design View

The following controls are available to navigate in design view, in addition to the general navigation controls described above.

	<p><b>Pan Right</b></p> <p>Keyboard: 'right arrow' key</p> <p>Mouse: <i>Press Scroll Wheel and Move Mouse Right</i></p>
	<p><b>Pan Left</b></p> <p>Keyboard: 'left arrow' key</p> <p>Mouse: <i>Press Scroll Wheel and Move Mouse Left</i></p>
	<p><b>Pan Up</b></p> <p>Keyboard: 'up arrow' key</p> <p>Mouse: <i>Press Scroll Wheel and Move Mouse Up</i></p>
	<p><b>Pan Down</b></p> <p>Keyboard: 'down arrow' key</p> <p>Mouse: <i>Press Scroll Wheel and Move Mouse Down</i></p>

#### Navigation in Orbit View

The following controls are available to navigate in orbit view, in addition to the general navigation controls described above.

	<b>Orbit Right</b> Keyboard: <i>'right arrow' key</i> Mouse: <i>Press Scroll Wheel and Move Mouse Right</i>
	<b>Orbit Left</b> Keyboard: <i>'left arrow' key</i> Mouse: <i>Press Scroll Wheel and Move Mouse Left</i>
	<b>Orbit Up</b> Keyboard: <i>'up arrow' key</i> Mouse: <i>Press Scroll Wheel and Move Mouse Up</i>
	<b>Orbit Down</b> Keyboard: <i>'down arrow' key</i> Mouse: <i>Press Scroll Wheel and Move Mouse Down</i>

### Navigation in Flyover View

The following controls are available to navigate in flyover view, in addition to the general navigation controls described above.

	<b>Move Right</b> Keyboard: <i>'right arrow' key</i> Mouse: <i>Press Scroll Wheel and Move Mouse Right</i>
	<b>Move Left</b> Keyboard: <i>'left arrow' key</i> Mouse: <i>Press Scroll Wheel and Move Mouse Left</i>
	<b>Move Forward</b> Keyboard: <i>'up arrow' key</i> Mouse: <i>Press Scroll Wheel and Move Mouse Up</i>
	<b>Move Back</b> Keyboard: <i>'down arrow' key</i> Mouse: <i>Press Scroll Wheel and Move Mouse Down</i>
	<b>Look Right</b> Mouse: <i>Press Left and Right Buttons and Move Mouse Right</i>
	<b>Look Left</b> Mouse: <i>Press Left and Right Buttons and Move Mouse Left</i>
	<b>Look Up</b> Mouse: <i>Press Left and Right Buttons and Move Mouse Up</i>



### Look Down

Mouse: *Press Left and Right Buttons and Move Mouse Down*



All cameras are described in one video called [Getting Started - Navigation](#). These links start the video at the camera of interest.

- [Design View Camera](#)
- [3D View Camera](#)
- [3D Flyover Camera](#)

## Construction Phases

Construction phases allow you to break your project into multiple phases of work. For example, a typical earthworks project would have a strip phase and a bulk earthworks phase as a minimum.

Understanding the concept of construction phases is key to making full use of *Kubla Cubed*

In *Kubla Cubed* the tabs that run along the bottom of the screen are referred to as 'construction phases' or just 'phases'. Earthworks and measurement elements that you create will be added to the selected phase only, the volumes shown on the screen relate to the selected phase only rather than an accumulation of all volumes in the project.

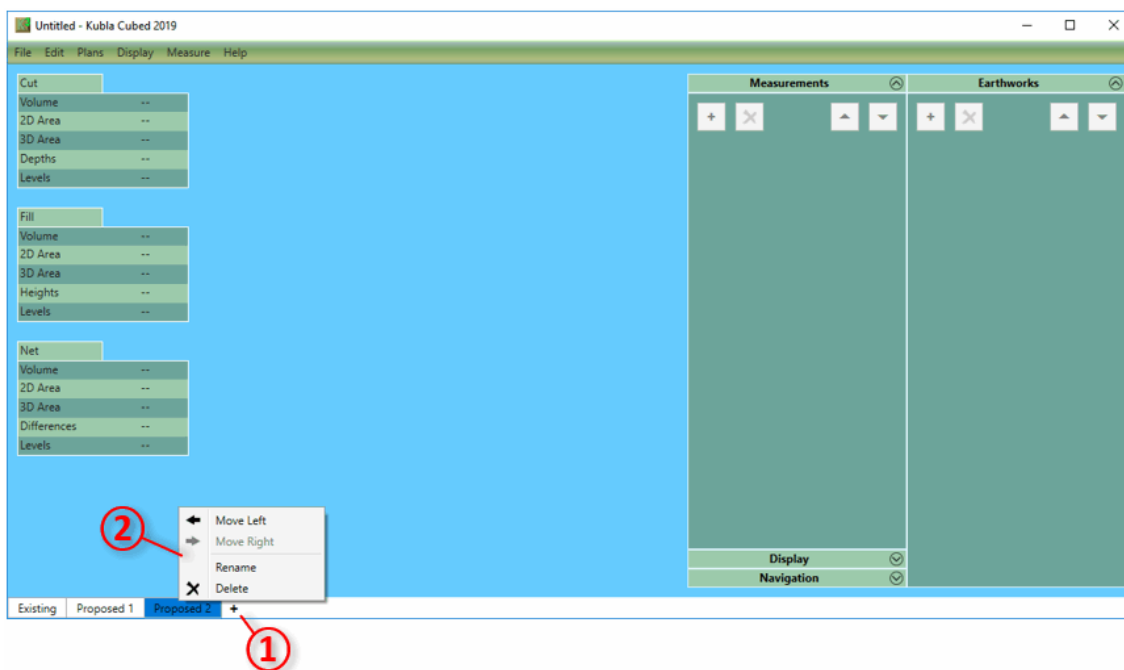

The first phase always contains the existing ground, any number of subsequent proposed phases can be created. There are two main reasons to create more than one proposed phase:

- It allows earthworks volumes and measurements to be separated into logical sections (e.g topsoil, bulk earthworks, paving).
- It allows a new set of calculations to be completed using the proposed elevations of the previous phase as the new ground.

The second item is particularly important. Consider a backfill operation: in the first proposed phase you define a trench which cuts into the existing ground. In *Kubla Cubed* each phase does calculations on two surface, a ground surface (taken from the previous phase) and a proposed surface (defined with earthworks elements). In a single phase there is no way to calculate backfilling the trench as if you place earthworks over the trench it will overwrite that section of the proposed rather than calculate a separate 'fill' volume. Earthworks elements in a single phase are

combined together to create a single proposed surface they do not produce cut/fill volumes from intersecting with each other. Instead what we need to do in this scenario is to create another phase, effectively baking the result of the trench cut into the ground of the next phase. The ground of the new phase will be the proposed from the last and so it is now possible to calculate backfilling the trench as part of a separate operation. Other common scenarios that require this are if you need to complete topsoil stripping or a demolition before bulk earthworks.

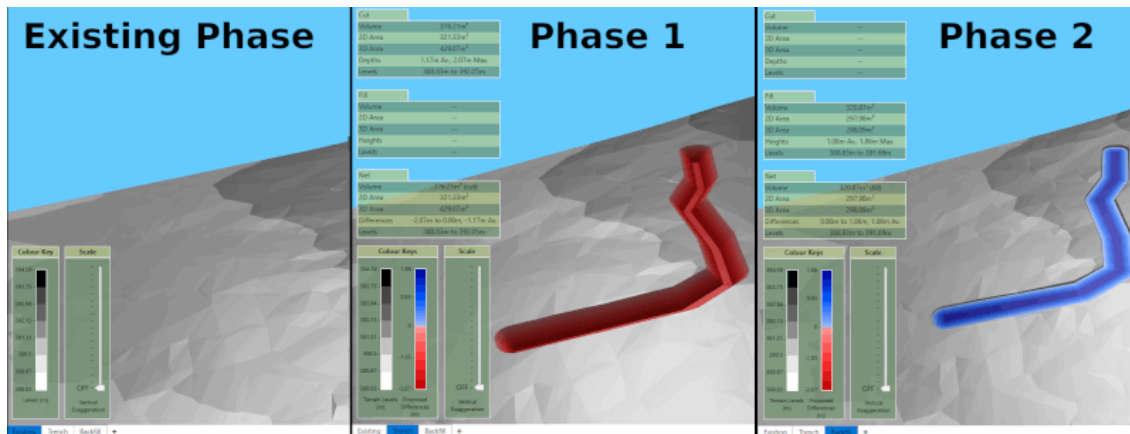

To **add** a new construction phase, click on the + button ① and type a name for the new phase. If you want to delete or rename a construction phase then **right click** on the tab and a menu will appear ② with these options.

To **move** an phase one place left or right you can use the **right click** menu. You can also drag and drop phases by pressing the **left mouse** down on a phase and moving the pointer to the new position, while keeping the mouse button down until it's in the drop position.



In our video [Understanding Construction Phases & Calculation Order](#) we talk about two critical concepts that must be fully appreciated to master the program.



---

# Chapter

# 3

---

## Display

---

### Topics:

- [Changing Background Color](#)
- [Display Panel](#)
- [On-Screen Statistics](#)
- [Single Camera Mode](#)
- [Presentation Mode](#)
- [Colour Keys](#)
- [Vertical Exaggeration](#)

You can adjust the display of your project in a number of ways, including the type of camera to use, the way to shade surface, and whether or not to display incline lines for the batter slopes.

## Changing Background Color

Options for changing the background colour can be changed via the 'View' menu and then selecting 'Background Colour'. The Colour can be changed by clicking on the square next to the word 'colour'. There are a range of pre-defined colours but custom colours can also be created.

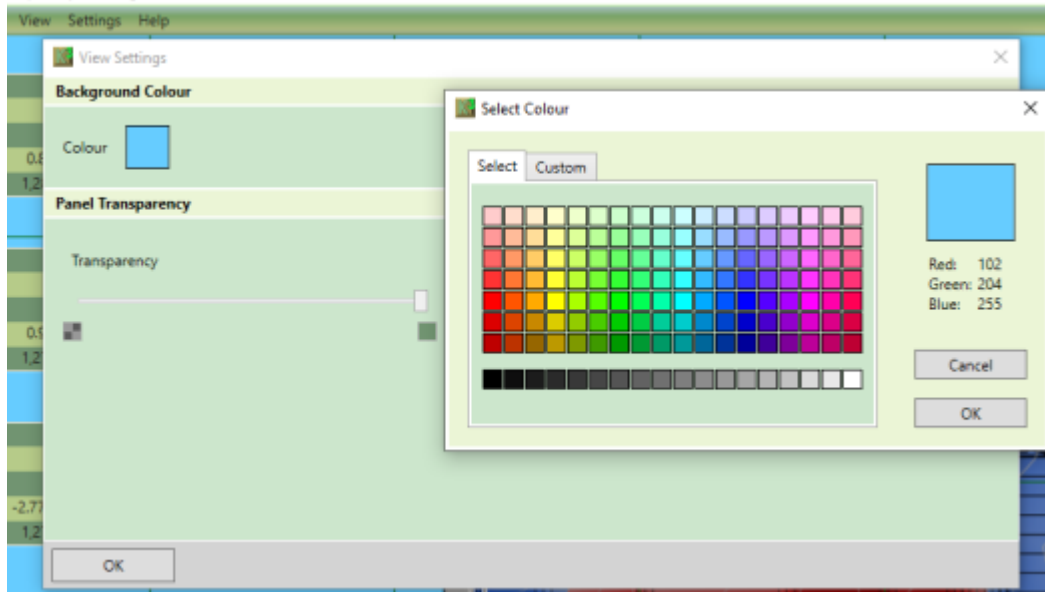



Moving the horizontal slider (within the 'Panel Transparency' section) furthest right, will make the entire interface completely opaque. Likewise, sliding fully left will render all but text and essential interface options, fully transparent.



## Display Panel

You can adjust the display of your project in a number of ways, including the type of camera to use, the way to shade surface, and whether or not to display incline lines for the batter slopes.

The Display panel provides controls which are used to adjust the display of the current phase.



It is important to note that lines and site plans are not currently displayed in either of the 3d views. For this reason, all controls which relate to the display of lines will be disabled when either of the 3d cameras are selected.

	<p><b>Camera Selector</b></p> <p>This dropdown allows you to choose the camera used to display the project. This is used to determine whether you are display in 2d or 3d modes. For more information see <a href="#">Cameras</a> .</p>
	<p><b>Lighting Mode</b></p> <p>This dropdown allows you to choose the lighting which is used to display the project. Options include hard lighting, soft lighting and no lighting.</p>
	<p><b>Earthworks Shading Mode</b> <i>(Not in Existing Tab)</i></p> <p>This dropdown allows you to choose the method used to shade the proposed earthworks. Options include cut &amp; fill, levels and match existing.</p>

	<p><b>Lines Display Mode</b> <i>(Not in Existing Tab)</i></p> <p>This dropdown allows you to choose the lines which are displayed for the proposed earthworks. Options include outlines only, outlines and include lines and no lines.</p>
	<p><b>Toggle Selection Lines</b> <i>(Not in Existing Tab)</i></p> <p>This button allows you to choose the turn the selection lines for the earthworks elements on and off.</p>
	<p><b>Toggle Grid Lines</b></p> <p>This button allows you to turn the grid lines on and off.</p>



## Lighting

There are three different lighting options that can be used to display the existing and proposed terrain, as described below.

	<p><b>Hard Lighting</b></p> <p>This option will light the terrain with hard edges. This lighting mode give a clear representation of variations in slopes throughout the terrain and is particularly useful for validating defined levels.</p>
	<p><b>Soft Lighting</b></p> <p>This option will light the terrain with smoothed edges. This can give a visually attractive representation of the terrain. However, it can also smooth hard edges in the terrain which can provide an unrealistic representation of the ground levels.</p>
	<p><b>No Lighting</b></p> <p>This option turns off all lighting. This option is useful for clear representations (particularly in 2D) which show the difference in levels by colour and where the variation in slope does not need to be visualised.</p>



## Line Work

There are three options for the display of earthworks lines as described below.

	<p><b>Inline Lines</b></p> <p>This option will display the outlines of the earthworks, as well as lines indicating the direction of the batter slope.</p>
	<p><b>Outlines Only</b></p> <p>This option will display only the outlines for the earthworks.</p>
	<p><b>No Lines</b></p> <p>This option will not display any lines for the earthworks.</p>

## Earthworks Shading

There are three modes than can be used to shade the earthworks.

	<p><b>Shade Earthworks Cut / Fill</b></p> <p>This option will colour the earthworks by cut / fill depth. It is particularly useful for visualising where the cut and fill will be highest in the project area.</p>
	<p><b>Shade Earthworks Levels</b></p> <p>This option will colour the earthworks by level with a totally independent colour scheme to that used by the existing terrain. This is useful when you need to show the earthworks levels, but you want to make a clear distinction from the existing ground.</p>
	<p><b>Match Ground Shading</b></p> <p>This option will colour the earthworks exactly the same as the existing ground so that it appears as a single surface. This mode is useful for quickly visualising what the final terrain will look like once the earthworks are completed.</p>

## On-Screen Statistics

The Cut, Fill and Cut & Fill summaries for the selected phase, are displayed in the top left corner. These will be hidden while editing elements. Options determining the level of detail, are set within the Project Settings which are found in the top menu under Settings → Onscreen Results.

In the image below, all options have been ticked/enabled.

<p><b>Cut</b></p> <p>Volume 778.168m<sup>3</sup></p> <p>2D Area 3,179.250m<sup>2</sup></p> <p>3D Area 3,242.688m<sup>2</sup></p> <p>Depths 0.245m Av., 0.730m Max.</p> <p>Levels 390.144m to 393.632m</p>	<p><b>Project Settings</b></p> <p>Measurement Units Onscreen Results</p> <p><b>Statistics to display</b></p> <p><input checked="" type="checkbox"/> Cut Values</p> <p><input checked="" type="checkbox"/> Volume</p> <p><input checked="" type="checkbox"/> 2D Area</p> <p><input checked="" type="checkbox"/> 3D Area</p> <p><input checked="" type="checkbox"/> Max Depth</p> <p><input checked="" type="checkbox"/> Average Depth</p> <p><input checked="" type="checkbox"/> Max Level</p> <p><input checked="" type="checkbox"/> Min Level</p> <p>OK</p>
<p><b>Fill</b></p> <p>Volume 3,555.920m<sup>3</sup></p> <p>2D Area 6,354.023m<sup>2</sup></p> <p>3D Area 6,598.341m<sup>2</sup></p> <p>Heights 0.560m Av., 3.936m Max.</p> <p>Levels 388.925m to 394.266m</p>	
<p><b>Cut &amp; Fill</b></p> <p>Net Volume 2,777.752m<sup>3</sup> fill</p> <p>2D Area 9,533.273m<sup>2</sup></p> <p>3D Area 9,841.029m<sup>2</sup></p> <p>Differences -0.730m to 3.936m, 0.291m Av.</p> <p>Levels 388.925m to 394.266m</p>	

## Single Camera Mode

Each phase can have a separate camera assigned but these can be synchronised. The decision on whether to navigate through each phase with its own camera, or whether to sync navigation between phases depends on the situation. Where each phase is focussed on different parts of the site it may be easier to navigate independently, whereas if each phase is building up parts of the same area it can be easier to sync the navigation. When Single Camera Mode is set, all phases will begin using the same camera as used on the current phase. To toggle this setting, in the menu, select View, Single Camera Mode.

## Presentation Mode

Kubla Cubed has a presentation mode in case you to show the software in a presentation. This removes all the editing controls as well as the title bar, so that you can see in full screen all of the relevant project content. To enter presentation mode click on View and then Presentation Mode. Alternatively, press Ctrl and F together (CTRL+F). Press Escape to exit (Esc)

## Colour Keys

The shading schemes used to display the terrain and earthworks can be amended by the user. *Kubla Cubed* comes with a number of pre-set colour tables, which have options for the user to customise them (e.g. discrete or blended shading).

It is also possible for the user to generate their own colour tables for fully customised output.

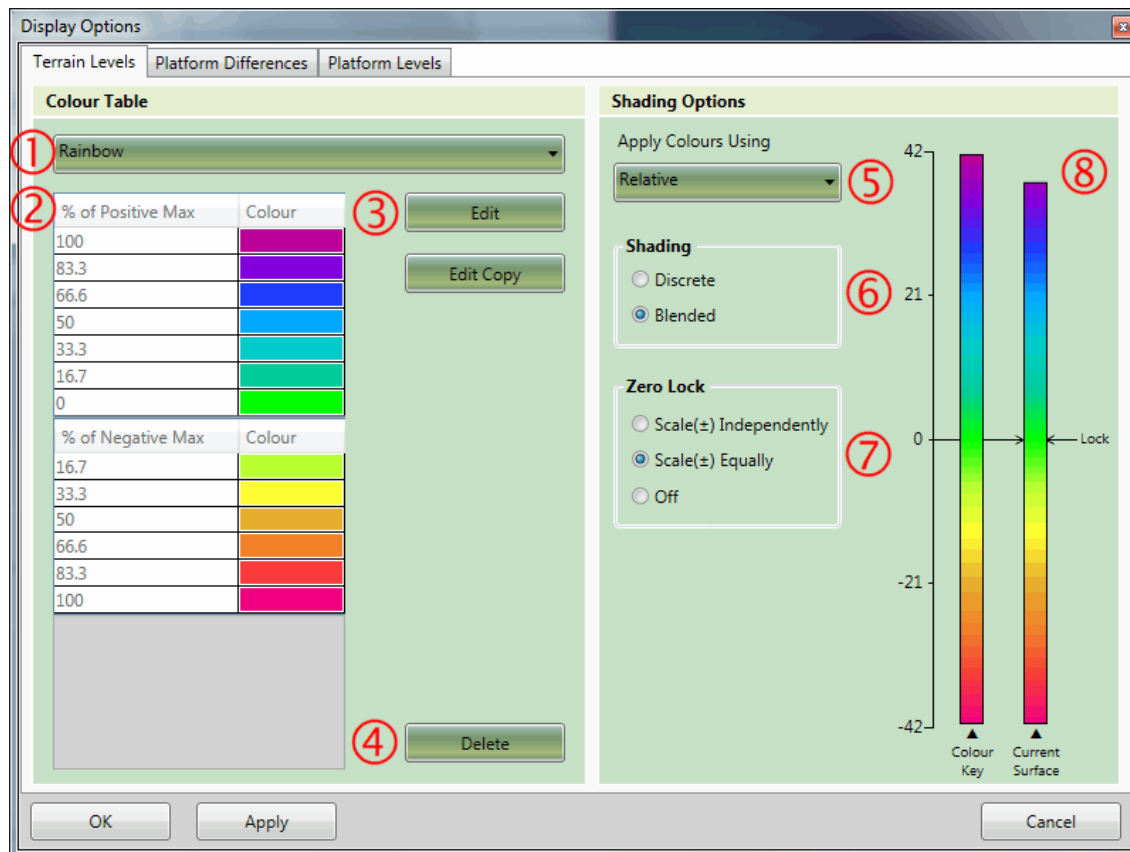

The shading schemes used to display the terrain and earthworks can be fully customised. The Display menu contains options for editing the shading schemes for terrain levels, earthworks differences and earthworks levels. Each earthworks display mode uses different shading schemes:

- Match Terrain Shading Terrain Levels.
- Shade Earthworks Levels Terrain Levels and Earthworks Levels.
- Shade Earthworks Differences Terrain Levels and Earthworks Differences.

A shading scheme is made up of a table of colours with corresponding values ②. There is a library of these colour tables to choose from and a shading scheme's colour table can be changed by selecting a different one from a drop-down box ①. You can manage the library of colour tables by deleting ④ those that are no longer needed as well as creating and amending existing ones with the Edit or Edit Copy buttons ③.

On the hand side of a shading scheme tab are options for controlling the way the colour table is applied to a surface (i.e. the existing terrain or earthworks). When you select different options the diagram ⑧ updates to show where on the surface the colours will be displayed.

Apply Colours Using ⑤ This is where the method by which the colour table is applied to the surface is chosen. The two methods are:

- Relative A shading scheme using the relative shading will scale the scheme to fully cover the surface which is being shaded. For this reason, in relative mode colour table values show as percentages. This method is useful for ensuring that the surface uses the full range of colours in the table, and it will adapt as the design is changed.
- Absolute The absolute method applies colours using the exact values in the table. This gives total control in regard to where the colours are applied on the surface. However, it does not adapt when new terrain is loaded or earthworks changes so it may need to be manually adjusted when there are significant changes.

Shading ⑥ There are two different shading options Blended and Discrete. When blended is selected the surface is shaded by smoothly interpolating between the colours in the colour table. With discrete shading colours are not blended, resulting in discrete blocks of the same colour. See the image below for an illustration of the difference between these two shading modes.

A consequence of using an absolute scheme with discrete shading is that the last colour in the table will not be used. This is because the first two values are used for the range of the first colour, the second and third for the next and so on, resulting in the last colour being redundant. In relative mode the values are adjusted to make use of all the colours in the table.

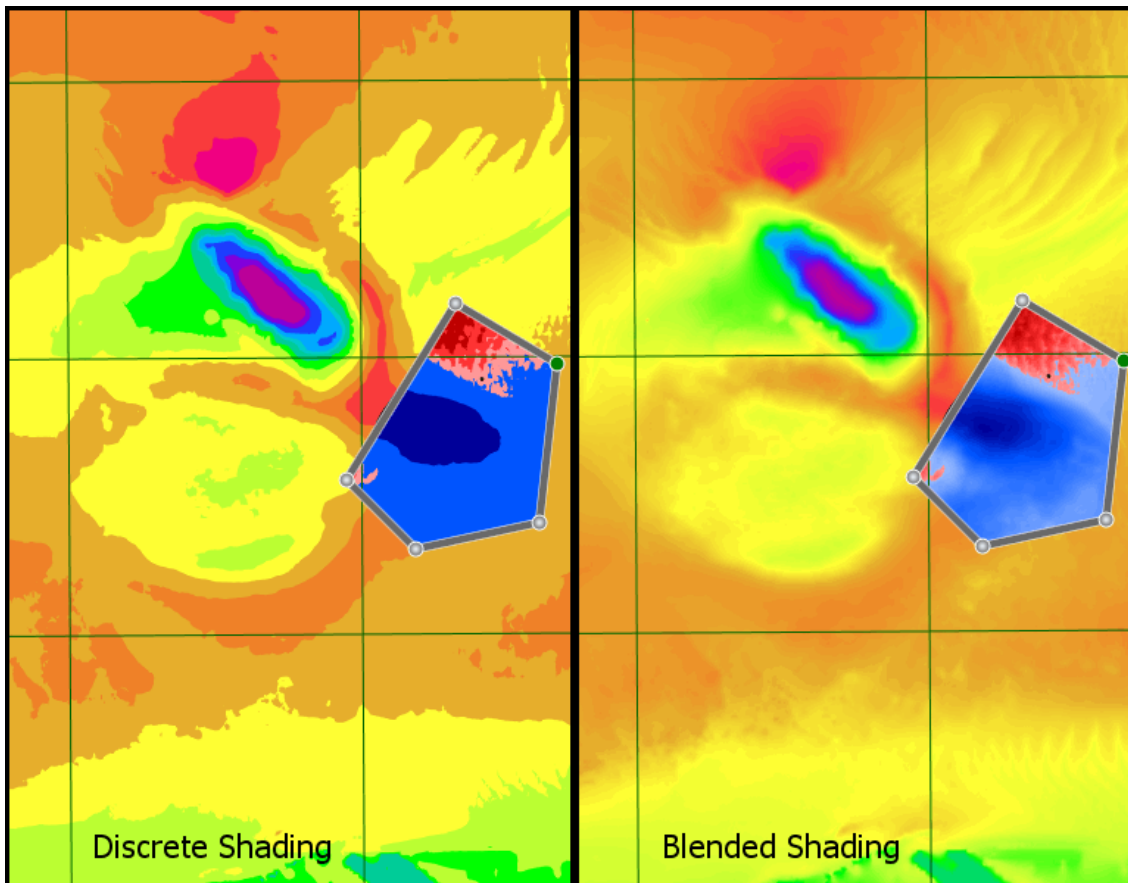

Zero Lock ⑦ It is often a requirement when shading a surface that a particular colour is locked to zero. For instance, when shading terrain you might want a colour locked at zero to indicate the difference between land and sea, or to show the areas on a platform in different colours for cut and fill (in difference shading mode). With absolute shading schemes this is simply a matter of setting a colour value to zero. However, with relative shading it is a little more complicated, as the 'zero' value will be move as it is scaled to fit the surface being shaded.

To resolve this there is a zero lock feature that locks any colour with a value of zero to zero on the surface. The two different zero lock options are:

- Scale  $\pm$  Independently This scales both positive and negative values independently so that the colour table covers the entire surface. This is useful when you want to display the full range of colours in the table for maximum contrast.
- Scale  $\pm$  Equally This option scales values above and below zero equally. This is useful in many situations, particularly for a cut and fill shading scheme so that you can get a feeling for the depths of cut compared to fill. However, with this option not all of the values in the table will be displayed.



Learn about the shading scheme options in our video [Adjusting Shading of Surfaces](#) which includes a demonstration on creating your own custom shading schemes.

## Vertical Exaggeration

When the model is in 3D mode, a vertical slider will appear on the bottom left corner of the screen. The purpose is to exaggerate the visualisation of elevation differences - i.e. it does not alter the values or calculations. This is beneficial

when checking that there are no erroneous extreme values, or to highlight differences in the terrain when working with a relatively flat model.

Dragging the slider's handle upward, will increase the exaggeration. Dragging the handle downward will reduce exaggeration.

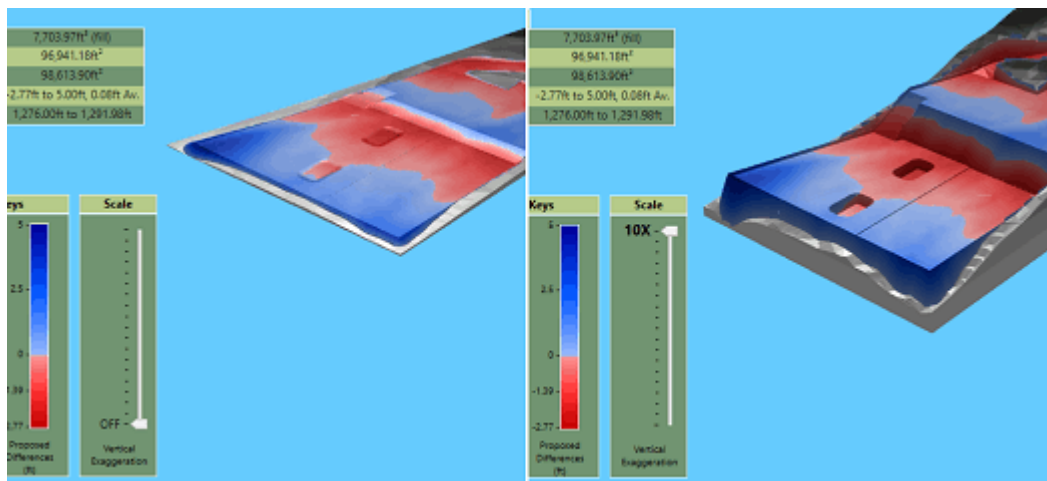

Above: 3D Orbit View camera in use; left without vertical exaggeration, right with maximum vertical exaggeration. Calculations remain unchanged as the exaggeration applies to the visualisation only.



---

# Chapter

# 4

---

## Site Plans

---

### Topics:

- [Overview](#)
- [Quick Measure Tool](#)
- [Editing Modes](#)
- [Adding a Site Plan](#)
- [Setting the Position and Cropping](#)
- [Setting the Transparency](#)

Site plans can be loaded into *Kubla Cubed* and displayed on the screen. This allows the user to draw lines off the loaded plan, and to generally have an awareness of the location of objects in the real world. Kubla Cubed supports the following file groups: CAD, image (e.g. .gif) and PDF.

## Overview

*Kubla Cubed* allows you to load site plans into your project from a number of different file formats (.pdf, .jpg, .bmp, .tiff). You can also import a site plan from CAD (\*.dwg). You can import as many site plans as you need, switching them on and off when you need to view them.

Being able to display multiple site plans makes it much easier to complete a take-off if you have your existing and proposed elevation data on two separate drawings. You can also use the crop, move, and align tools to 'stitch' drawings together in situations where a single site plan is spread across separate pages of a document.

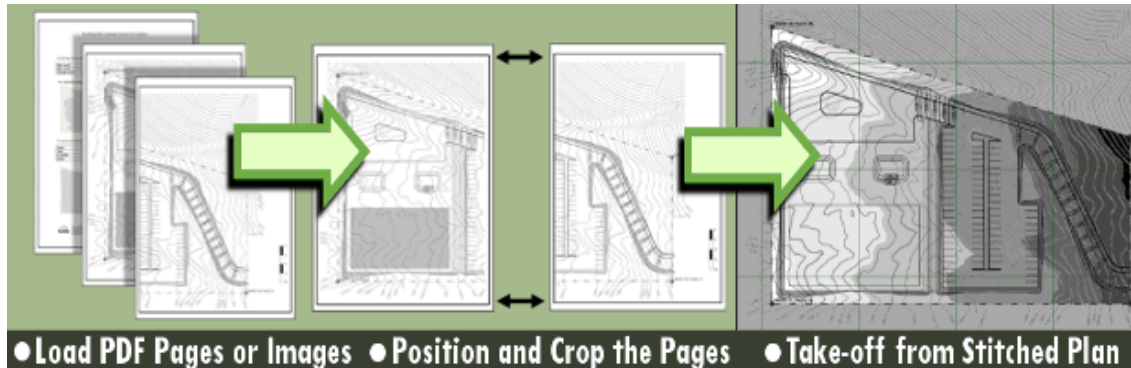

Site plans are adjusted by clicking on the Plan menu item. The menu item will appear as shown below.

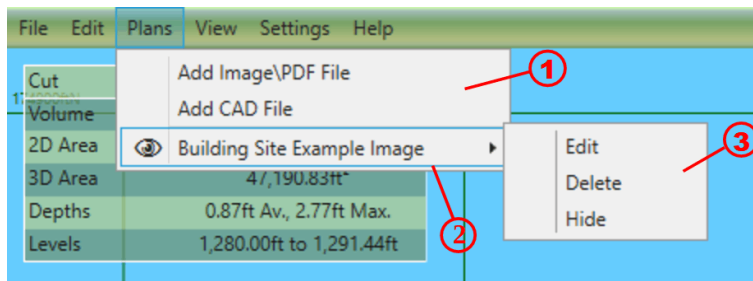

You can add as many site plans as you need to, which allows you to show a site which is presented on multiple drawings, or to show both the existing and proposed even if they are in separate drawings. The site plans are added and adjusted using the controls described below:

- ① Click here to add a new site plan. You can load site plans from CAD, PDFs or image file formats (.bmp, .jpg, .tiff)
- ② This is where the list of site plans which you can defined will be displayed.
- ③ Use this menu to edit, delete or hide existing site plans.



The [Site Plans - Overview](#) video provides a quick demonstration of options available for adding, modifying and viewing site plans.

## Quick Measure Tool

It is often necessary when creating a project to do a quick measurement of a length, this is particularly true if a site plan has been scaled or CAD data imported. Checking a known length can ensure that no mistakes have been made when scaling or when selecting the units of CAD data. To activate the quick measure tool hover the mouse over the point you want to measure from and press the M key. Whilst keeping the M key pressed move the mouse to the next

point and a line between the two will be displayed with a label showing the distance. The measure tool can be used in any window where project data is displayed.

### Measure Tool Copy

By default the quick measure tool displays the distance measured in a label next to the cursor. However you can copy details of each measurement to the clipboard if required. To do this you need to make sure that Measure Tool Copy is ticked in the cursor menu. Then after completing a measurement with the M key, the details of the quick measure operation will be copied to the clipboard. After copying go to a document or spreadsheet and paste either using the Edit menu of the program or using the universal Ctrl+V shortcut for pasting.

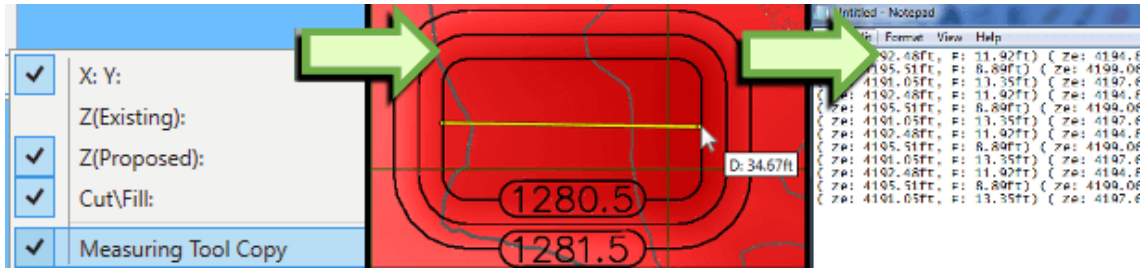

## Editing Modes

There are two modes of editing available in the software:

- Pop-In Mode. In this mode you edit items on top of the main window. The advantage of this is that it allows you to see the items you are editing on top of other project items. It also allows you to align the new items you draw with the other project items.
- Pop-Out Mode. In this mode items are edited in a separate window and you do not see other project items behind it. Although this mode is generally less often used, it can sometimes be useful to isolate the items being edited, and remove needless clutter from the screen.

The controls that are available are the same regardless of the editing mode, although the layout of these controls is slightly different. The following three buttons are always present:

- OK. Clicking this button will apply to changes you have made to the project, and finish editing.
- Apply. Clicking this button will apply the changes you have made to the project, but allow you to continue editing. This button is not visible when editing site plans in In Screen mode, since you are already seeing the changes as applied.
- Cancel. Clicking this button will cancel the changes you have made to the project, and finish editing.

The following controls are used to switch between Pop-In and Pop-Out editing modes.

	If you are using Pop-In mode you can click this icon at the top-centre of the screen to switch to Pop-Out mode.
	If you are using Pop-Out mode you can click this icon at the top-right of the screen to switch to Pop-In mode.

## Adding a Site Plan

Site Plans can be added from CAD or Image/PDF. To load a new site plan, click Plans in the menu bar and then Add Image/PDF file or Add CAD file.

You will be prompted to select the file which you want to load. If you choose a PDF file with several pages you will be prompted to choose which page to load.

After this the following window will be displayed:

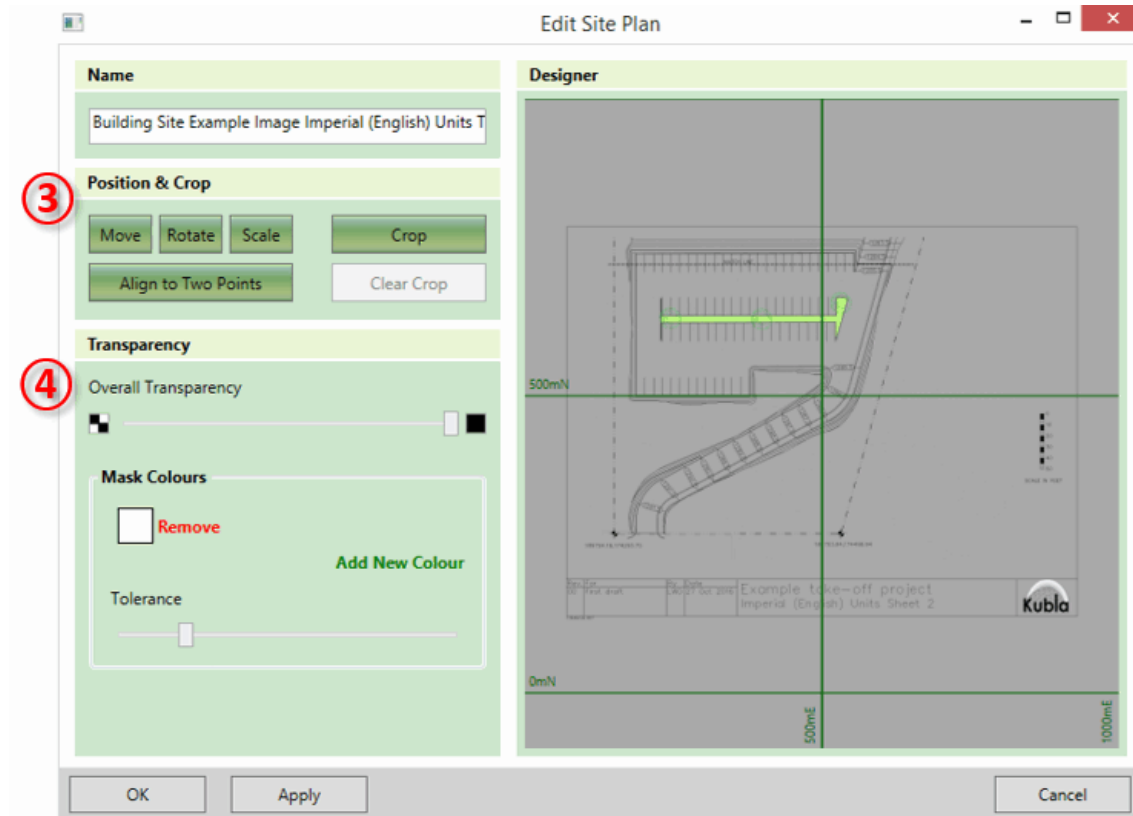

The different elements of this window are summarised below. They are described in more detail in the following sections.

- ③ This is where the position and scale of the loaded image, in the real world, will be specified. You can also choose to crop the image if you wish. This option is particularly useful for drawings which have title blocks which you want to remove
- ④ This is where transparency can be set, so that the user can see through the loaded site plan.

The setting of the image position, crop and the transparency is described further in the following sections.

## Setting the Position and Cropping

The site plan is positioned into its real-world location by scaling, moving, and rotating the image as required. Alternatively, if you have two known co-ordinates on the image you can define these and the software will scale, rotate and move the image to match these two co-ordinates.

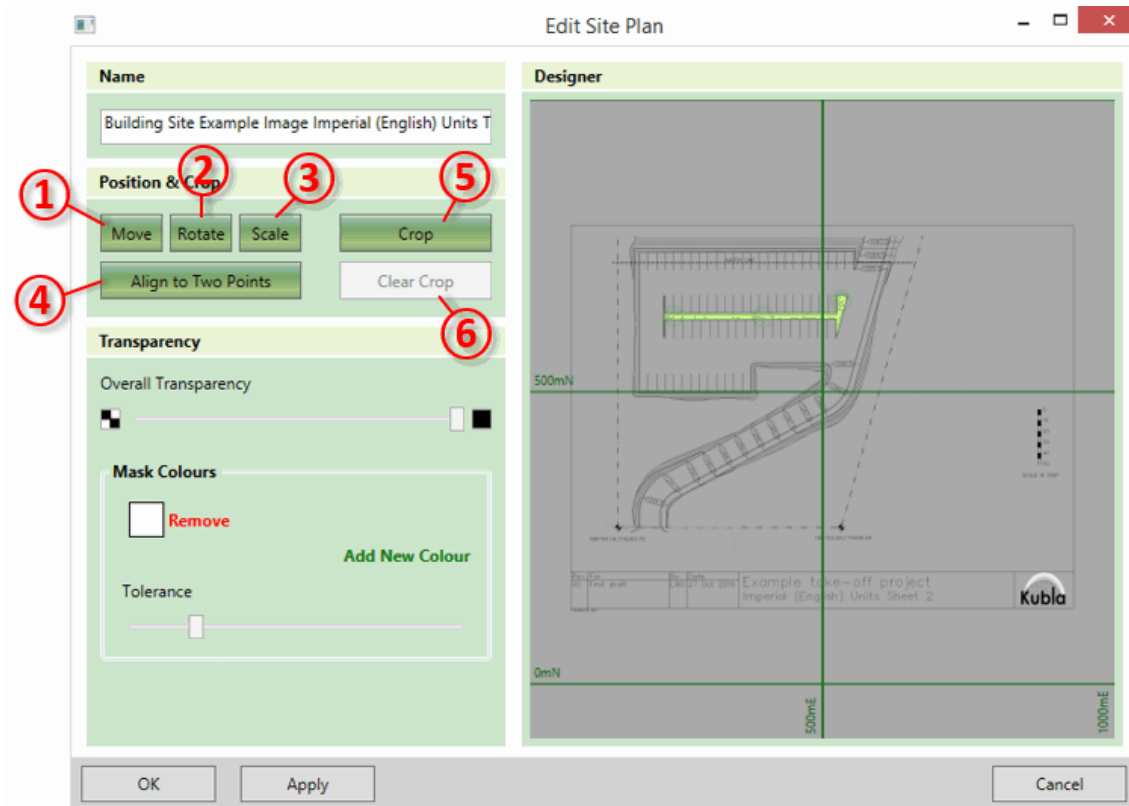

The following controls are used to define the image's position:

- ① Move

This option allows you to move the image by defining a point on the image and then typing its position in the real world. This is useful if there is a co-ordinate defined on your image. It is important to remember that you should move the image after you have done any scaling and rotation you need to do, because these operations will cause positions on the image to change.

- ② Rotate

This option allows you to rotate the image by defining a north reference angle on the image. This is useful if you want to show your image in a different orientation to that on the image. E.g. you want it aligned north-vertical and there is a north arrow on the image (which is not vertical)

- ③ Scale

This option will scale the image. You can do this with one of two methods:

1. By scale (CAD & PDFs only). Type a defined scale such as 1:100, or 1"=25'.
2. By Length. Specify a length on the image and then type its length in the real world. This option is particularly useful if you have a defined length on your image. E.g. a scale bar or a marked dimension.

- ④ Align to two points

This is the easiest option if you have two co-ordinates defined in the image. It allows you to specify the two points on the image and then type their co-ordinates in the real world. The software will then scale, move and rotate as required to match these two points.

Once you have selected one of these options, you will receive further instructions depending on the option you selected. These are described below:

- Move
  1. **Select a base point to move**  
Define the point which you want to move by clicking once in the preview.
  2. **Type or click on screen to set the new position of the base point**  
Type the location (X and Y) that you want this point to be moved to. Alternatively you can click on the screen to set the new point position to another screen location.
- Rotate
  1. **Draw the north arrow (base to tip)**  
Draw a line on the preview to define your reference north angle. Click once to start drawing the line and a second time to finish.
- Scale
 

Select the option you wish to use ('By Scale' or 'By Length') and then...

  1. **Specify the new scale**  
Type the new scale for the PDF.  
... OR ...
  1. **Draw a line along a scale guide or any other known length**  
Draw a line on the preview to define your reference length. Click once to start drawing the line and a second time to finish.
  2. **Enter the new length**  
Type the length you want the reference length to be scaled to.
- Align to two points
  1. **Select the first point to align**  
Define the position of the first reference point by clicking once in the preview.
  2. **Type or click on screen to set the new position of the first point**  
Type the location (X and Y) that you want the first point to be moved to. Alternatively you can click on the screen to set the new position to another screen location.
  3. **Select the second point to align**  
Define the position of the second reference point by clicking once in the preview.
  4. **Type or click on screen to set the new position of the second point**  
Type the location (X and Y) that you want the second point to be moved to. Alternatively you can click on the screen to set the new position to another screen location.

Once you completed the instructions on the prompts, the prompt will disappear and the image will be adjusted as you have specified.

You can also crop the site plan to remove any unnecessary borders and titles. This is done by clicking on the Crop<sup>⑤</sup> button. You will be prompted to draw the crop rectangle on the screen. You can clear this crop by clicking on Clear Crop<sup>⑥</sup> and you can always adjust it by clicking again on the Crop<sup>⑤</sup> button.



We have two great videos... [Site Plans - Scaling and Positioning](#) introduces scaling e.g. 'By Length' and also relative positioning; [Site Plans - Cropping](#) shows you how to remove unwanted site plan imagery.

---

## Setting the Transparency

When a new site plan is added to a project the white colour is removed. This means site plan documents with a white background will have the background removed leaving just the line work for take-off or reference. You can remove the default colour to restore a white background or set different colours to remove.

Sometimes when a site plan has different coloured areas you need to set multiple mask colours, one for each colour you wish to remove. There is a tolerance slider to control how strict the colour matching is.

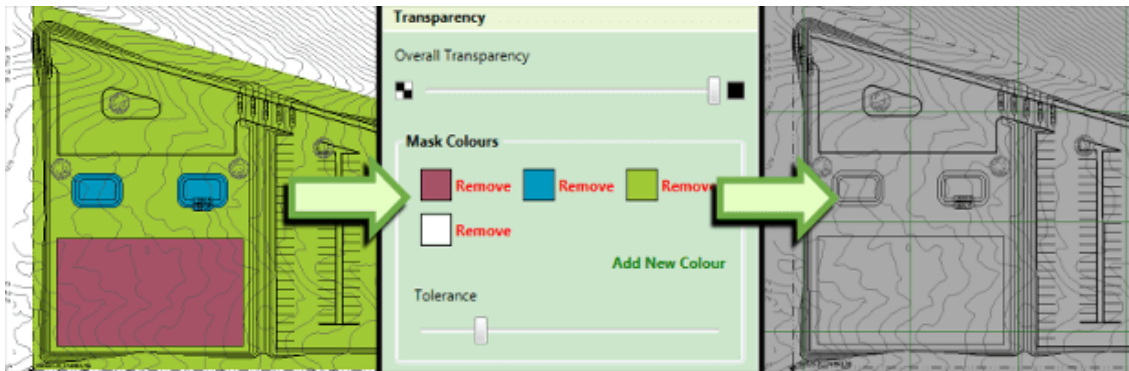

Since the site plan will be displayed on top of the existing terrain and earthworks, it is necessary to give it transparency so that it's possible to see through the plan to the layers below. In many cases the default transparency settings will be suitable. However, when the transparency needs to be adjusted this can be achieved using the controls shown below.

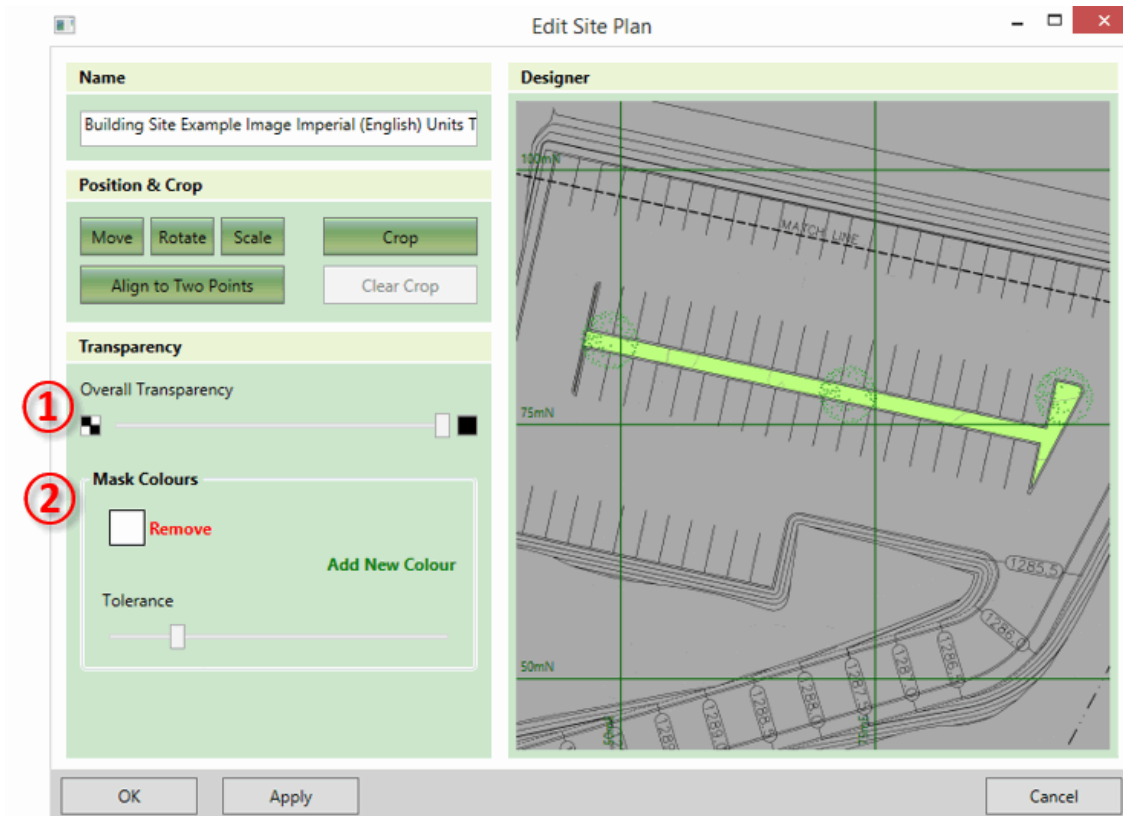

These controls work together as follows:

- ① This slider can be used to define the overall transparency to apply to the whole image. If set to its minimum (the default) there will be no overall transparency. As the slider is moved to the right the overall transparency will be increased until at the maximum value the image will completely disappear.
- ② These controls can be used to completely mask out specified colours. By default, there is a mask on white, which is the background colour for most drawings. Additional mask colours can be set by clicking add new colour and then clicking a point on the preview to select a colour. Mask colours can be changed by clicking into the colour box and selecting a new colour on the screen, and they can be removed by clicking remove.

It is possible to also remove colours which are similar to the selected mask colour(s) by adjusting the tolerance slider. If the slider is set to its minimum only exact matches on the mask colour(s) will be removed. As the tolerance value is increased more and more colours will be removed in a widening band around the specified colour(s).



An explanation for the transparent background requirement is provided in the video [Site Plans - Transparency](#). This video also provides instructions on how apply/remove transparency further.

---



---

# Chapter

# 5

---

## Elevation Elements

---

### Topics:

- [The Elements Panel](#)
- [Calculation Order](#)
- [Relative Elements](#)
- [Absolute Elements](#)

Kubla Cubed provides multiple options to define earthwork levels. Some thought has to be given to the best earthworks elements to use in any given scenario. When required, a number of elements can be used together to create the proposed earthworks. Earthworks elements can be divided into two groups in regard to how their elevations are defined :

- **Absolute Elements:** These elements are defined by explicit levels. The Platform, Slope, Path, Feature Surface and Triangle Surface all fall under this category. If they intersect with another element and are lower in the calculation order they will effectively overwrite the element below.

**Note:** Backward compatibility: Paths defined in Kubla Cubed 2019 and older, could be defined by heights and as such were a hybrid of absolute and relative. When opened in Kubla Cubed 2021 and later, Paths defined by heights are automatically converted into relative elements: Trenches or Berms, depending on whether they were mainly cut or fill, respectively.

- **Relative Elements:** The next type are Relative Elements. The Reduce, Raise, Trench and Berm elements come under this category. For these elements you do not input a level but instead a depth or height by which to adjust the existing ground or the level already defined by elements lower in the calculation order. If these elements intersect with other elements lower in the calculation order, they do not overwrite them, instead they will adjust their level up or down.

Whenever designing a proposed surface by combining multiple earthworks elements it is important to ensure that you are confident that you have defined the level you intended. To check hover the mouse cursor over various points on your designed surface to ensure the proposed Z value is what you expected. Please see the section on [cursor label](#) for more information.

## The Elements Panel

Each phase in a project contains an earthworks panel. This is where earthworks elements such as platforms, slopes, paths and feature surfaces can be added to the project. The earthworks elements in a panel are combined together to create a single proposed surface within a single phase.

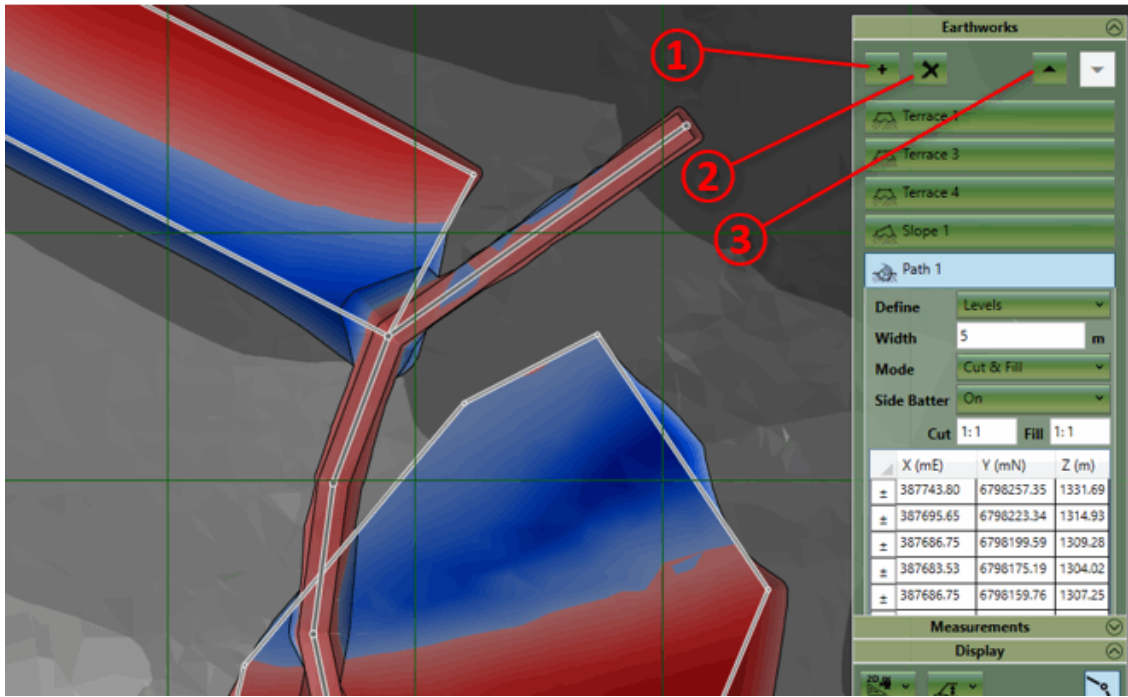

### Adding Elements

New elements can be added to the earthworks panel by clicking on the + symbol ①. You will be presented with the following list of elements that you can add :

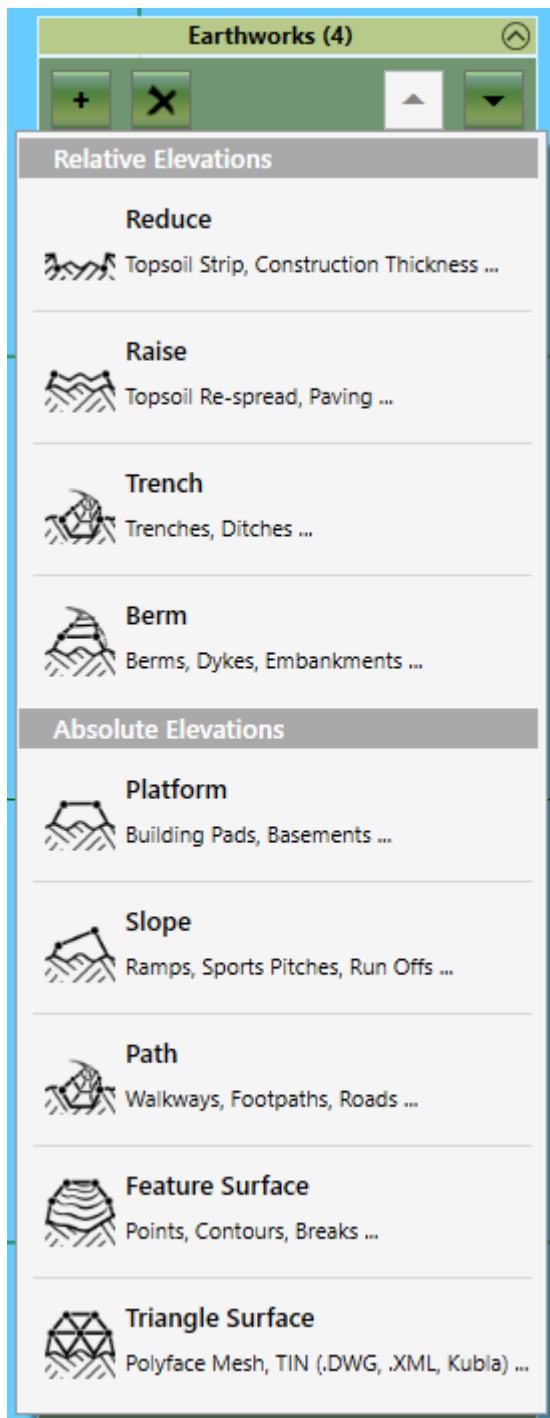

- **Reduce**

The Reduce element removes a specified thickness of material from a specified area of the site. This is very commonly used for stripping topsoil from the existing ground. For more information see [Reduce Element](#) .

- **Raise**

The Raise element adds a specified thickness of material to a specified area of the site. This is most commonly used for paving. For more information see [Raise Element](#) .

- **Trench**

The Trench element adds a trench of a specified width with a specified centreline to the site. This is most commonly used for utility trenches, etc. For more information see [Trench Element](#) .

- **Berm**

The Berm element adds a berm of a specified width with a specified centreline to the site. This is most commonly used for embankments, dikes, etc. For more information see [Berm Element](#) .

- **Platform**

The platform element adds a specified area with a specified elevation to the site. I.e. a flat area. This is most commonly used for defining building pads and retention ponds. For more information see [Platform Element](#) .

- **Slope**

The slope element adds a specified area with a specified slope to the site. This is most commonly used for access ramps and run-offs. For more information see [Slope Element](#) .

- **Path**

The path element adds a path of a specified width with a specified centreline to the site. This is most commonly used for access roads and trenches. For more information see [Path Element](#) .

- **Feature Surface**

The feature surface element adds a surface defined with elevation 'features' (outlines, contours, break-lines and points). This is most commonly used for take-offs such as those required by contractors for bidding purposes. For more information see [Feature Surface Element](#) .

- **Triangle Surface**

The triangle surface element is used to define a surface using a triangulation imported from another file. This is most commonly used to import data from other programs which support triangulations (TINS). For more information see [Triangle Surface Element](#) .

When you have selected an element you will be able to start drawing its boundary or centreline points in the design area. **Left click** to place a new point, **right click** or press **Enter** to complete the creation of the element. If you want to cancel the operation entirely hit **Esc** key. When adding new elements the **back space** key can be used to undo the last placed point if a mistake has been made.

### Renaming Elements

After an element is created it is a good idea to give it a relevant name so it can be identified in the report (e.g building pad 1 or car park). To do this just double click on the name of the element and then over-type.

### Editing Elements

**Selection :** Elements can be selected by **left clicking** on the title bar in the earthworks panel or by **left clicking** on there boundary or centre lines in the design area. Multiple elements can be selected by holding down **Ctrl** whilst making the selection. To deselect an element you can **right click** on it.

**Edit Mode :** If you double click on an element it will enter into 'edit mode', the properties of the element will be exposed and you will be able to edit the definition points of the element in the design view. To exit 'edit mode' **double left click** in empty space in the design view.

**Definition Points :** When an element is in 'edit mode' the definition points of the boundary or centreline can be changed. In the design view **left click** on a point and drag it to the desired position. A point can be deleted by using the **Delete** key. New points can be inserted by selecting a line and hitting the **Z** key. Points can also be edited directly in the point list in the element properties. Clicking on the top right corner of the point list allows all the points to be copied using the menu command or **Ctrl+C**. Likewise a list of points can also be pasted into the point list from another program by clicking on the top right corner and using menu paste command or **Ctrl+V**.

**Properties:** For information on the individual element properties refer to the relevant sections for each element.

**Notes on Point Snapping :** When creating or editing the definition points of a earthworks element it is possible to snap the points to other element definition points or to defined grid positions. To access the point snapping options click on the **Edit** menu and then the **Snap Points**. Here you can toggle snapping to boundary points and grid points as well as setting the interval and origin point of the grid used for snapping.

### Amending the Calculation Order

You can amend the order of elements in the list by selecting an element and using the up down buttons ③. The order of earthworks becomes critically important when two or more earthworks intersect. The calculation order can change the way that the proposed surface is built and thus change the cut & fill estimate of a project. For more information refer to the [calculation order](#) section of the user guide.

### Copying & Pasting

It is often useful to copy and paste elements, this can be done using **Edit** menu commands or the keyboard shortcuts (**Ctrl+C**, **Ctrl+V**). You can copy and paste in the same phase to duplicate an element or copy and paste to move elements to different phases.

### Deleting Elements

Elements can be deleting by first selecting them and then clicking on the X button at the top of the panel ②.

## Calculation Order

**Note that the calculation order is only important if you have earthworks elements which intersect at different levels.**

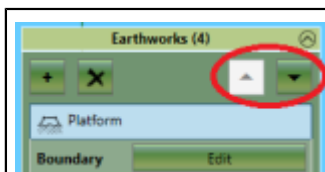

In *Kubla Cubed*, it is possible to have intersecting earthworks elements. However, this can introduce a complication since it must be specified whether the level in the intersection region will be controlled by one element or the other. This is dictated by the 'calculation order' - in effect the order that the earthworks elements are 'built' within the software.

Consider the following example, of two 'cut and fill' earthworks elements. If one element has a level of +10m and another is at +20m and they intersect, then what is the level of the resultant area where they intersect? In *Kubla Cubed* the answer is that it will be the level of the element which is lower in the calculation order.

**Note:** Changing the calculation order may affect elements other than the one selected. For example, a Reduce element 'Reduce\_1' which has depths from set to a Platform called 'Platform\_1'... if 'Platform\_1' is moved to the bottom of the list, 'Reduce\_1's depth will be set from the next Absolute element above it.

The image below illustrates the example described above. These two elements intersect at different levels, and they are both in 'cut and fill' mode. If the element at +10m is above the element at +20m in the calculation order (left image), then the higher element will fill over the top of the lower element. However, if the calculation order of these two elements is reversed (right image) then the lower element will instead cut material out of the higher one.

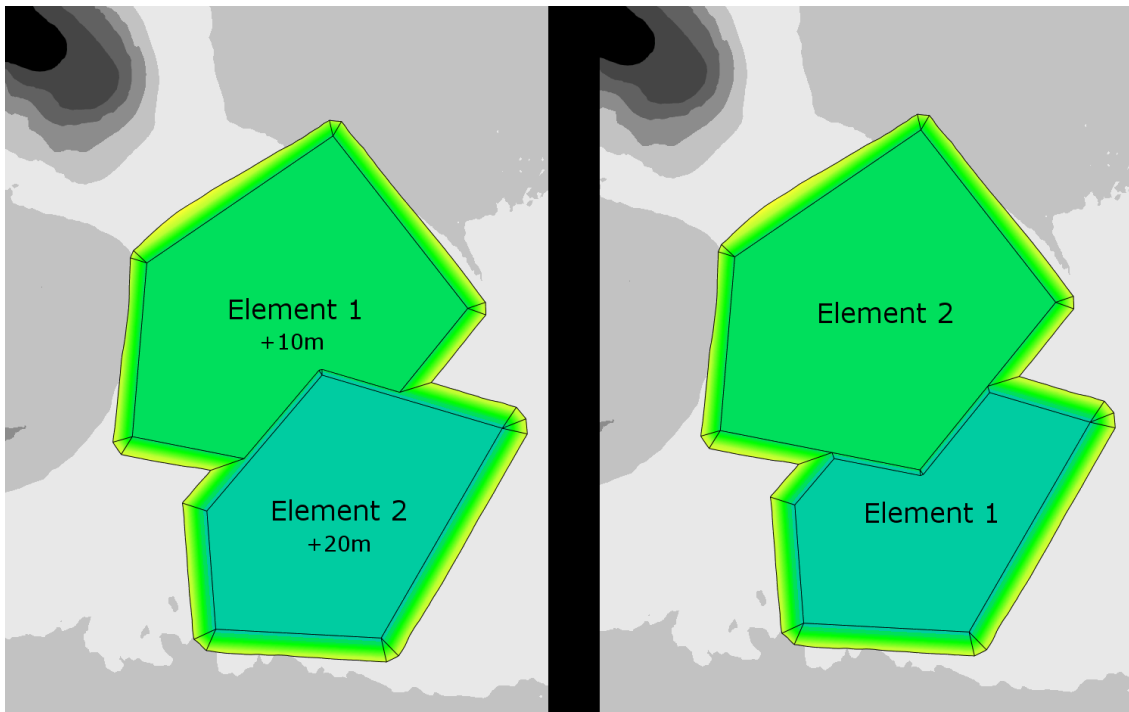

[Understanding Construction Phases & Calculation Order](#) are two topics that users must fully appreciate to master the program. These powerful concepts are studied in context through various scenarios and demos.

## Relative Elements

Reduce, Raise, Trench and Berm, are all Relative element types.

In Kubla Cubed relative elements are those that are specified with heights or depths. For instance a trench defined as 2ft below the ground surface is defined with a relative depth. The alternative form 'absolute elevations' would have elevations defined from a fixed datum (e.g. 156m from Sea Level). Typically existing terrain is defined with absolute elevations whereas proposed terrain can be defined with a combination of relative and absolute elevations. A topsoil strip for example will almost always be defined with relative elevations (1 ft topsoil strip) whereas building pads will be defined with absolute elevations (245ft FFL).

Each element that is defined by depths, has an inverted counterpart defined by heights. The Trench has depth values while the Berm has height values, however both are defined by a centerline. Similarly, the reduce element's opposite number is the raise element. You can specify heights in a depth element and/or depths in a height element, by using negative values.

Relative elements all have a property called 'Depths From' or 'Heights From'. This allows you to specify what surface you wish the elevations to be relative to. An obvious choice is to make them relative to the ground surface. This means they will override each other in areas of intersection where the element lower in the calculation order takes precedence. However, having the elevations relative to ground is not always desirable, for instance if you wanted to reduce a slab level for a material thickness in a specific area you would want the depths defined from the slab level, not the ground. The ability to change what the depths/heights are relative to, is extremely powerful allowing you to adjust the surface of lower elements in the calculation order, as well as the ground. You can select a named element, the previous element or ground.

When the 'Auto' option is active the option is dynamically set to the first absolute element above it in the calculation order. If there aren't any, it is set to ground. It can be conceptually confusing to have relative elements adjust each

other, especially for new users to the program, so the auto option ensures the relative elements adjust only from previous absolute elements in the calculation order or ground if no absolute elements are found. The option is dynamic so you can add and remove elements and all the relative adjustments elements will update accordingly.

## Reduce Element

The Reduce element is used to remove a fixed thickness of material from an area of the site. This element is most commonly used for stripping topsoil at the start of a project, and for making subgrade adjustments.

The properties that are exposed for the Reduce element are summarised below.

- **Boundary**

Boundary button provides access to the editor wherein the definition points can be defined for the outline of the Reduce area.

- **Depth**

This is the depth of material that you wish to remove from the Reduce area.

- **Depths From**

This setting dictates from what surface the specified depths are relative to. 'Ground' can be selected or you can select the 'Previous Element' if you want the depths to be relative to the surface when the previous element in the calculation order is built. You can also select a named element. When the 'Auto' option is active 'Depths From' is dynamically set to the first absolute element above it in the calculation order. If there aren't any, it is set to ground. The behaviour when 'Auto' is active is desirable in most circumstances.

- **Side Batter**

The Reduce boundary is joined to the ground by side slopes. The side batter (set as a ratio of vertical to horizontal) dictates the angle of these slopes. Turning side batter off will result in the Reduce being joined to the ground with vertical sides.



[Topsoil Stripping](#) looks at using the Reduce element to complete topsoil stripping operations and explains the importance of always having the strip depths defined on a different phase to subsequent earthwork elevations.

## Raise Element

The Raise element is used to add a fixed thickness of material to an area of the site. This element is most commonly used for adding paving or topsoil.

The properties that are exposed for the Raise element are summarised below.

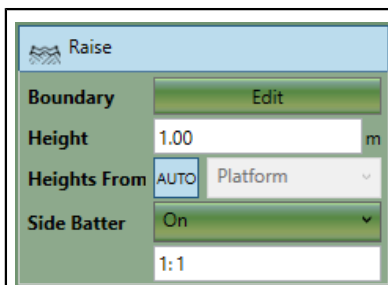

- **Boundary**

Boundary button provides access to the editor whereby the definition points can be defined for the outline of the Raise area.

- **Height**

This is the height of material that you wish to add from the Raise area.

- **Heights From**

This setting dictates from what surface the specified heights are relative to. 'Ground' can be selected or you can select the 'Previous Element' if you want the heights to be relative to the surface when the previous element in the calculation order is built. You can also select a named element. When the 'Auto' option is active 'Heights From' is dynamically set to the first absolute element above it in the calculation order. If there aren't any, it is set to ground. The behaviour when 'Auto' is active is desirable in most circumstances.

- **Side Batter**

The Raise boundary is joined to the ground by side slopes. The side batter (set as a ratio of vertical to horizontal) dictates the angle of these slopes. Turning side batter off will result in the Raise being joined to the ground with vertical sides.

## Trench Element

The Trench element is used to define a linear path with a fixed width and defined depths. This element is most commonly used for trenches.

The properties that are exposed for this element are summarised below.

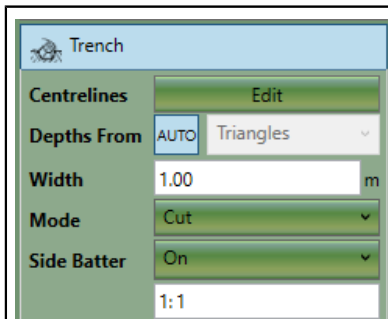

- **Centrelines**

The edit button will open the take-off window so that you can define the centrelines which define the Trench.

**Note:** Depths are specified with positive values

- **Depths From**

This setting dictates from what surface the specified depths are relative to. 'Ground' can be selected or you can select the 'Previous Element' if you want the depths to be relative to the surface when the previous element in the calculation order is built. You can also select a named element. When the 'Auto' option is active 'Depths From' is dynamically set to the first absolute element above it in the calculation order. If there aren't any, it is set to ground. The behaviour when 'Auto' is active is desirable in most circumstances.

- **Width**

This is the width of the path.

- **Mode**

This is used to specify if the element should have cut, fill or both. Most commonly cut and fill will be specified.

- **Side Batter**

The Trench boundary is joined to the ground by side slopes. The side batter (set as a ratio of vertical to horizontal) dictates the angle of these slopes. You can set different side batter angles for side slopes that cut



into the ground and for those that fill into it. Turning side batter off will result in the Trench being joined to the ground with vertical sides.



Estimates for linear structures like trenches, roads and causeways can be easily created. Learn how with the video: [Proposed Earthworks : The Path](#). Please note that for more **complex roads**, we would recommend using the Feature Surface with varying level outlines and a centre line (defined by a break-line).

## Berm Element

The Berm element is used to define a raised linear path with a fixed width and variable heights. This element is most commonly used embankments.

The properties that are exposed for this element are summarised below.

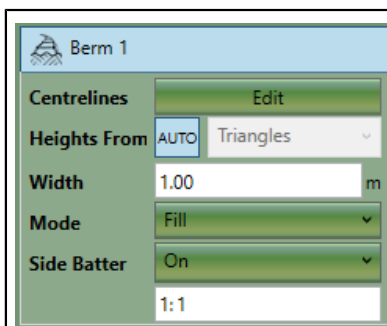

- **Centrelines**

Edit button provides access to the editor wherein the definition points can be defined for the outline as well as the heights for the Berm.

- **Heights From**

This setting dictates from what surface the specified heights are relative to. 'Ground' can be selected or you can select the 'Previous Element' if you want the heights to be relative to the surface when the previous element in the calculation order is built. You can also select a named element. When the 'Auto' option is active 'Heights From' is dynamically set to the first absolute element above it in the calculation order. If there aren't any, it is set to ground. The behaviour when 'Auto' is active is desirable in most circumstances.

- **Width**

This is the width of the Berm.

- **Mode**

This is used to specify if the element should have cut, fill or both. Most commonly cut and fill will be specified.

- **Side Batter**

The Berm boundary is joined to the ground by side slopes. The side batter (set as a ratio of vertical to horizontal) dictates the angle of these slopes. You can set different side batter angles for side slopes that cut into the ground and for those that fill into it. Turning side batter off will result in the Berm being joined to the ground with vertical sides.

Between the Cut and Fill is a button which (when depressed) will Synchronize Side Batters.



Estimates for linear structures like trenches, roads and causeways can be easily created. Learn how with the video: [Proposed Earthworks : The Path](#). Note: for more **complex roads**, we would recommend using the Feature Surface with varying level outlines and a centre line (defined by a break-line).

## Absolute Elements

Platform, Slope, Path, Feature Surface & Triangle Surface, are all Absolute element types.

Absolute elements are those that are specified to a fixed datum. For instance elevations that are specified from Mean Seal Level (MSL) would be described as absolute elevations in Kubla Cubed. On a typical site plan most hard landscape elevations will be marked with absolute elevation. Operations like topsoil strip and re-spread will often be described with relative elevations but they are frequently marked in the notes rather than on the plan itself. With the absolute elevation elements there are many different ways of specifying elevations. The platform element is specified with a single value as it is a horizontal plane. The slope element which is also a plane but inclined can be defined with 3 points or an incline arrow. The Feature Surface elevations are defined with a number of elevation features (contours, break lines and points) and finally the Triangle Surface elevations are taken from the imported triangles.

Unlike relative elements, absolute elements do not have a 'Depth From' or 'Heights From' field, however they do have 'Define' field which allows you to define by Level and an Offset. Offsets allow you to move all the points in an element by a set amount, this is utilised to adjust to sub grade in certain work-flows.

Elements defined with absolute elevations cannot adjust elevations from previous elements in the calculation order like relative elements can. Absolute elements explicitly define what the proposed level should be so they totally override all previous elements in the calculation order when they intersect. This capability can be very advantages allowing projects to be build up in different layers. For instance one element may be used specify general elevations and then more elements can be added with more detail in certain critical areas without having to snap the boundaries together.

### Platform Element

The platform element is used to add an area with a fixed elevation to the site. This element is most commonly used for building pads.

The properties that are exposed for the platform element are summarised below.

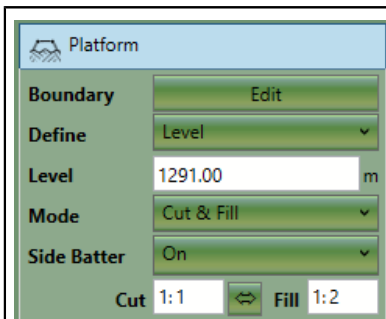

- **Boundary**

Boundary button provides access to the editor whereby the definition points can be defined for the outline of the platform area.

- **Define**

This is the way that the platform level should be defined. Options are 'level' which uses the level specified below without modification and 'offset' which applies an offset to the level specified. The offset option is mostly used to add construction thicknesses by specifying a negative offset.

- **Offset**

This option is only visible if offset options are selected in the 'Define' menu. It allows you to offset the entire platform in Z. This is useful for accommodating for a construction thickness.

- **Level**

This is the level that the platform area should be (subject to any offset defined above).

- **Mode**

This is used to specify if the element should have cut, fill or both. Most commonly cut and fill will be specified.

- **Side Batter**

The platform boundary is joined to the ground by side slopes. The side batter (set as a ratio of vertical to horizontal) dictates the angle of these slopes. You can set different side batter angles for side slopes that cut

into the ground and for those that fill into it. Turning side batter off will result in the platform being joined to the ground with vertical sides.

Between the Cut and Fill is a button which (when depressed) will Synchronize Side Batters.



Provided in this video is an overview of the Platform element's options for defining a fixed, flat area of proposed ground [Proposed Levels - Platform Element](#)

## Slope Element

The slope element is used to define a specified area with a uniform incline. This element is most commonly used for access ramps, sports pitches and run-offs.

The properties that are exposed for this element are summarised below.

The screenshot shows the 'Slope' properties panel with the following settings:

- Boundary:** Edit button
- Define:** Arrow dropdown menu
- Level:** Base (selected), Tip, Both
- Table:**

X (mE)	Y (mN)	Z (m)
189301.73	174330.41	1270.01
- Incline:** 1:5.357
- Mode:** Cut & Fill dropdown menu
- Side Batter:** On dropdown menu
- Buttons:** Cut 1:1, Synchronize Side Batters button, Fill 1:1

- **Boundary**

Boundary button provides access to the editor wherein the definition points can be defined for the points which define the outline of the slope area.

- **Define**

This option selects the controls you use to define the slope incline and elevation. The '3 Points' option can be used to define the plane of the slope. '3 Points & Offset' allows you to accommodate for a construction thickness. The other options are 'Arrow' and 'Arrow & Offset'. Using the arrow, you can specify a single elevation and an incline angle to define the slope or two elevations and allow the software to calculate the incline angle for you (for more details see below).

- **Offset**

This option is only visible if offset options are selected in the 'Define' menu. It allows you to offset the entire slope in Z. This is useful for accommodating for a construction thickness.

- **Levels**

This table specifies the points with levels that define the slope.

- **Mode**

This is used to specify if the element should have cut, fill or both. Most commonly cut and fill will be specified.

- **Side Batter**

The slope boundary is joined to the ground by side slopes. The side batter (set as a ratio of vertical to horizontal) dictates the angle of these slopes. You can set different side batter angles for side slopes that cut into the ground and for those that fill into it. Turning side batter off will result in the slope being joined to the ground with vertical sides.

Between the Cut and Fill is a button which (when depressed) will Synchronize Side Batters.

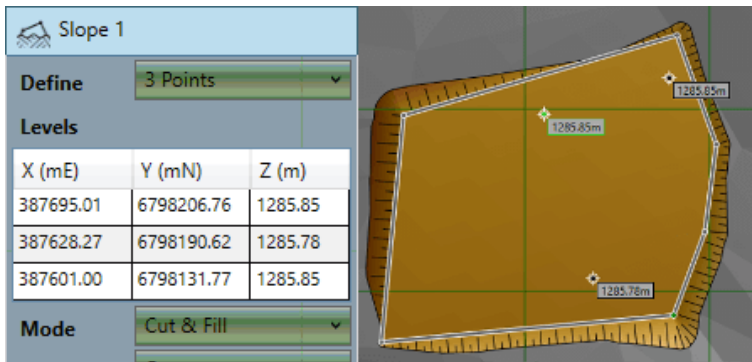

### Option 1: 3 Points

This option allows you to define a slope using three points. Three points explicitly define a plane. This option is more technical than the other options but can be useful if there are three elevations clearly marked on the drawing to use as reference.

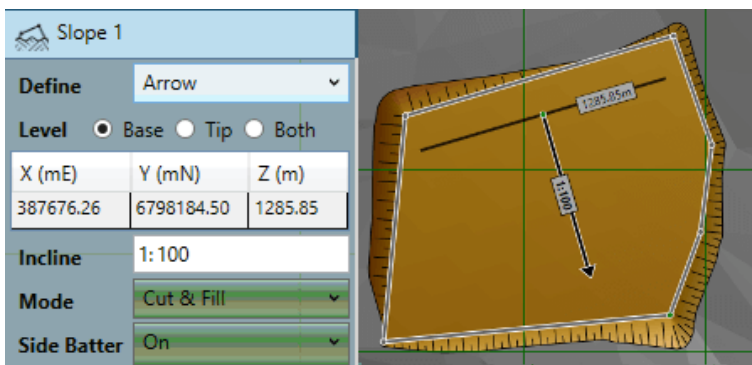

### Option 2: Arrow Base

This option allows you to define the slope with a single elevation at the base, an incline angle and a direction specified by the arrow. The arrow position can be controlled by dragging the tip, shaft or base of the arrow. The length of the arrow has no effect on the slope with this option.

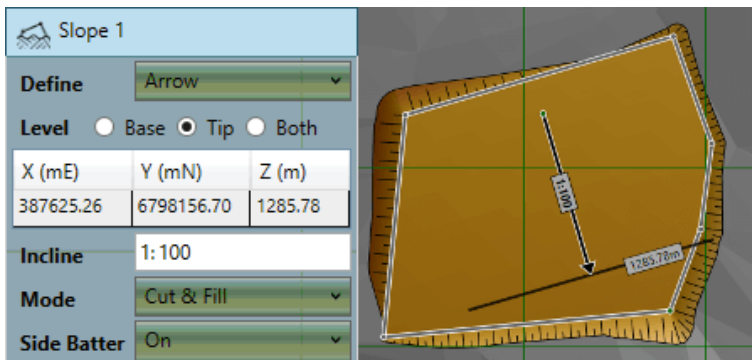

### Option 3: Arrow Tip

This option is similar to using an arrow and a base elevation but instead of specifying the elevation at the base of the arrow you specify one at the tip. Again, the arrow position can be controlled by dragging the tip, shaft or base of the arrow. The length of the arrow has no effect on the slope with this option.

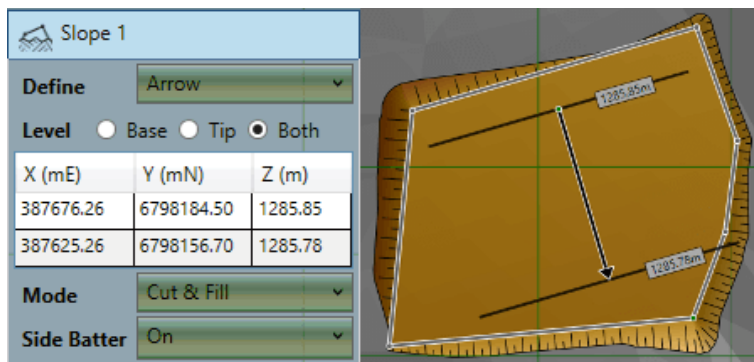

#### Option 4: Arrow Both

This option allows you to set the elevation of both the base and the tip of the arrow leaving the software to calculate the incline angle for you. This can be especially useful when creating ramps from one area to another when you know both elevations. You can move the arrow at the base and the incline of the ramp will adjust accordingly.



[Proposed Earthworks : The Slope Element](#) video describes slope creation by setting the angle of incline with the arrow tool, or via three values. This video will help you build ramps, run-offs and other sloping areas.

## Path Element

The path element is used to define a path with a fixed width and defined levels. This element is most commonly used for roads and trenches.

The properties that are exposed for this element are summarised below.

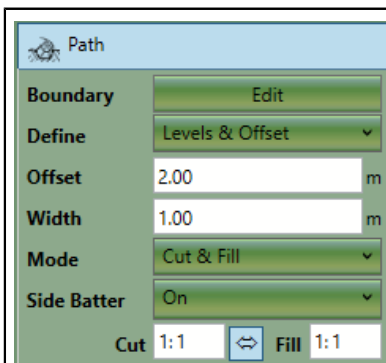

- **Boundary**

Boundary button provides access to the editor wherein the definition points can be defined for the outline as well as the levels (or depths) for the path. If levels & offsets are being defined, the levels entered into this table will be offset by the value specified.

- **Define**

This is the way that the path level should be defined. Options are 'levels' which uses the levels specified in the table below without modification, 'levels & offset' which applies an offset to the levels specified. The offset option is mostly used to add construction thicknesses by specifying a negative offset.

- **Offset**

This option is only visible if offset options are selected in the 'Define' menu. It allows you to offset the entire path in Z. This is useful for accommodating for a construction thickness.

- **Width**

This is the width of the path.

- **Mode**

This is used to specify if the element should have cut, fill or both. Most commonly cut and fill will be specified.

- **Side Batter**

The path boundary is joined to the ground by side slopes. The side batter (set as a ratio of vertical to horizontal) dictates the angle of these slopes. You can set different side batter angles for side slopes that cut into the ground and for those that fill into it. Turning side batter off will result in the path being joined to the ground with vertical sides.

Between the Cut and Fill is a button which (when depressed) will Synchronize Side Batters.



Estimates for linear structures like trenches, roads and causeways can be easily created. Learn how with the video: [Proposed Earthworks : The Path](#). Please note that for more **complex roads**, we would recommend using the Feature Surface with varying level outlines and a centre line (defined by a break-line).

## Feature Surface Element

The feature surface element is used to define a complex surface specified by outlines, contours, break-lines and points. This element is most commonly used for take-offs such as those needed by contractors for bidding purposes.

The properties that are exposed for this element are summarised below.

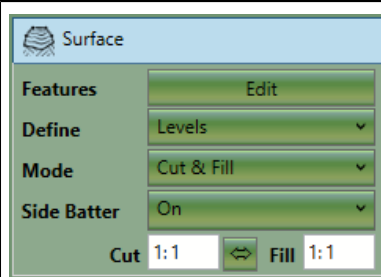

- **Features**

The edit button will open the take-off window so that you can define the outlines, contours, break-lines and points which define this surface. For more information on the options available in the take-off window see [Elements Panel](#)

- **Define**

This is the way that the surface levels should be defined. Options are 'levels' which uses the levels specified without modification, 'levels & offset' which applies an offset to the levels specified. The offset option is mostly used to add construction thicknesses by specifying a negative offset. Lastly a 'levels & 3d offset' option allows the surface to be adjusted in X and Y as well as in Z.

- **Offset**

This option is only visible if offset options are selected in the 'Define' menu. It allows you to offset the entire surface in X,Y and Z. This is useful for accommodating for a construction thickness of finding a balance.

- **Mode**

This is used to specify if the surface should have cut, fill or both. Most commonly cut and fill will be specified.

- **Side Batter**

The feature surface boundary is joined to the ground by side slopes. The side batter (set as a ratio of vertical to horizontal) dictates the angle of these slopes. You can set different side batter angles for side slopes that cut into the ground and for those that fill into it. Turning side batter off

will result in the feature surface being joined to the ground with vertical sides.

Between the Cut and Fill is a button which (when depressed) will Synchronize Side Batters.



Sometimes called a super element for its ability to produce the results of any other element, the 'Feature Surface' is described in the video [Proposed Levels - Feature Surface](#).

## Triangle Surface Element

The triangle surface element is used to add a triangulation into a project that has been originally created in another program (or Kubla Cubed project). The triangles cannot be edited once they are added to the project, all triangulation data needs to be imported from a file. The triangle surface supports importing data from LandXML (.xml), CAD (.dxf, .dwg) and Kubla Project files (.kcp).

The properties that are exposed for this element are summarised below.

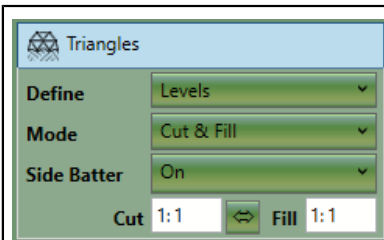

- **Define**

This is the way that the triangulation levels are defined. Options are 'levels' which uses the original levels from the triangulation, 'levels & offset' which applies an offset to the levels specified. The offset option is mostly used to add construction thicknesses by specifying a negative offset. Lastly a 'levels & 3D offset' option allows the surface to be adjusted in X and Y as well as in Z.

- **Offset**

This option is only visible if offset options are selected in the 'Define' menu. It allows you to offset the entire surface in X, Y and Z. This is useful for accommodating for a construction thickness of finding a balance.

- **Mode**

This is used to specify if the surface should have cut, fill or both. Most commonly cut and fill will be specified.

- **Side Batter**

The triangle surface boundary is joined to the ground by side slopes. The side batter (set as a ratio of vertical to horizontal) dictates the angle of these slopes. You can set different side batter angles for side slopes that cut into the ground and for those that fill into it. Turning side batter off will result in the triangle surface being joined to the ground with vertical sides.

Between the Cut and Fill is a button which (when depressed) will Synchronize Side Batters.



- The video [Existing Levels - Triangle Surface](#) provides a comprehensive study of the Triangle Surface and how to import TIN data into your project. Triangle data can be from CAD files and other sources. LandXML files (imported via the Triangle Surface) are given dedicated coverage in our video [Working with LandXML Files \(.xml\)](#)
-



---

# Chapter

# 6

---

## Measurement Elements

---

### Topics:

- [The Measurements Panel](#)
- [Count Element](#)
- [Length Element](#)
- [Area Element](#)
- [Volume Region Element](#)
- [Cross Section Element](#)

Kubla Cubed offers five different measurement elements that can be drawn on screen, to focus on a specific part of the model. Data pertaining to these elements can be viewed in the various exports (spreadsheet export, reports, etc.). Note that there are a variety of other measurement tools available, which are described in other sections.

## The Measurements Panel

Each phase in a project contains a measurements panel. This is where additional measurements such as counts, lengths, areas and cut/fill in specific regions can be added to the project. There is no requirement to add any elements to the measurements panel as a lot of data is reported in the standard report. However some supplementary measurements are often required in addition to the standard information.

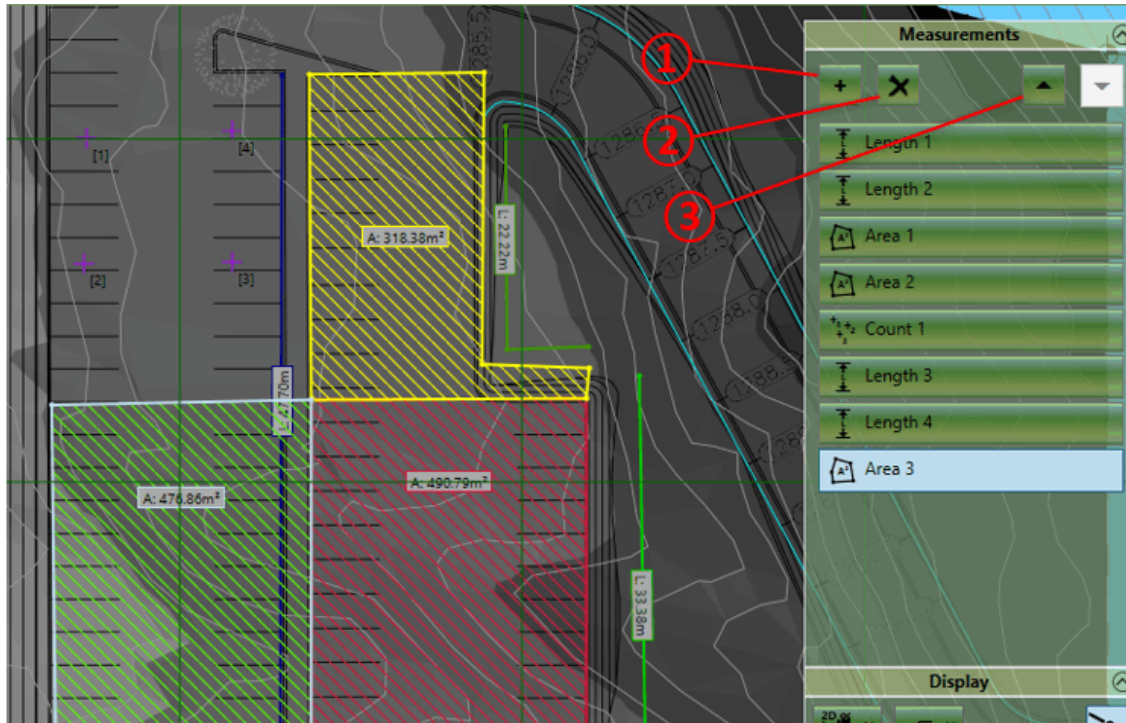

### Adding Elements

New elements can be added to the measurements panel by clicking on the + symbol ①. You will be presented with the following list of elements that you can add :

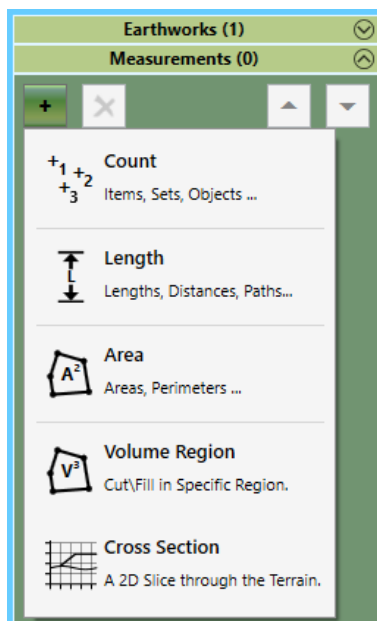

- **Count**

The count element allows you to record the position and number of various groups of assets on the site. You can use a count element to record the position of manholes or count the number of trees. For more information see [Count Element](#).

- **Length**

The length element allows you to measure distances on the site as well as record assets that have a length property such as kerbs and fences. Length elements can be closed to measure perimeters. It is worth noting that all earthworks elements report a boundary outline perimeter in the input data summary so there is no need to trace a line around any earthworks element. For more information see [Length Element](#).

- **Area**

The area element is used for measuring areas in the project. Areas of earthworks disturbance are recorded in the earthworks estimation summary so there is no need to measure these. Area elements only measure 2D areas as if they were measured from a paper plan. They don't measure the 3D surface area that can be found in the earthworks estimation report. For more information see the [Area Element](#).

- **Volume Region**

The volume region element is used for reporting cut/fill in different regions of a particular phase. It is worth noting that there is no requirement to have any volume regions in a phase. If none are defined the earthworks estimation report will still show a breakdown by element and results for all earthworks in the phase. For more information see the [Volume Region Element](#).

- **Cross Section**

The cross section element is used for visualising a cut through the terrain, displaying the existing and proposed terrain along the cross section. The cross section can be viewed in the software, and is also presented in some of the exports. For more information see the [Cross Section Element](#).

When you have selected an element you will be able to start drawing its boundary or centreline points in the design area. **Left click** to place a new point, **right click** or press **Enter** to complete the creation of the element. If you want to cancel the operation entirely hit **Esc** key. When adding new elements the **back space** key can be used to undo the last placed point if a mistake has been made.

### Renaming Elements

After an element is created it is a good idea to give it a relevant name so it can be identified in the report (e.g 'boundary fence' or 'flower bed'). To do this just double click on the name of the element and then overtype.

### Editing Elements

**Selection** : Elements can be selected by **left clicking** on the title bar in the earthworks panel or by **left clicking** on a elements boundary or centre lines in the design area. Multiple elements can be selected by holding down **Ctrl** whilst making the selection. To deselect an element you can **right click** on it.

**Edit Mode** : If you double click on an element it will enter into 'edit mode', the properties of the element will be exposed and you will be able to edit the definition points of the element in the design view. To exit 'edit mode'; **double left click** in empty space in the design view.

**Definition Points** : When an element is in 'edit mode' the definition points of the boundary or centreline can be changed. In the design view **left click** on a point and drag it to the desired position. A point can be deleted by using the **Delete** key. New points can be inserted by selecting a line and hitting the **Z** key. Points can also be edited directly in the point list in the element properties. Clicking on the top right corner of the point list allows all the points to be copied using the menu command or **Ctrl+C**. Likewise a list of points can also be pasted into the point list from another program by clicking on the top right corner and using menu paste command or **Ctrl+V**.

**Properties** : For information on the individual element properties refer to the relevant sections for each element.

**Notes on Point Snapping:** When creating or editing the definition points of a measurement element it is possible to snap the points to other element definition points or to defined grid positions. To access the point snapping options click on the Edit menu and then the Snap Points. Here you can toggle snapping to boundary points and grid points as well as setting the interval and origin point of the grid used for snapping.

### Amending the Order

You can change the order of elements in the list by selecting an element and using the up down buttons ③. Unlike the earthworks panel where the order of the earthworks can change the proposed elevations, the order of measurement elements has little consequence apart from changing which element shows on top if two intersect. You may want to change the order of elements so similar measurements are grouped together.

### Copying & Pasting

It is often useful to copy and paste elements, this can be done using Edit menu commands or the keyboard shortcuts (**Ctrl+C**, **Ctrl+V**). You can copy and paste in the same phase to duplicate an element or copy and paste to move elements to different phases.

### Deleting Elements

Elements can be deleting by first selecting them and then clicking on the X button at the top of the panel ②.

## Count Element

---

The count element allows you to record the position and number of various groups of assets on the site. For example, you can use a count element to record the position of manholes or count the number of trees.

The properties that are exposed for the count element are summarised below.

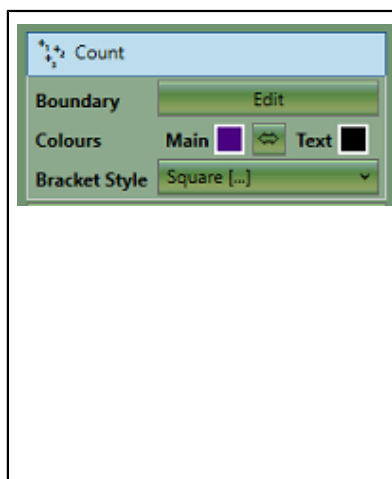

- **Boundary**

Boundary button provides access to the editor wherein the Points can be added/edited for the Count.

- **Colours**

Here you can set the Main and Text colour of the count element. This can be useful for visually seperating different area measurements or making them easier to see against the colours of the topography.

- **Bracket Style**

The bracket style allows you to change the style of the brackets enclosing the item number. This can also be used to visually separate different Count measurements in your project. You can set the bracket style to 'none' if you want to show the number without brackets.



The measurement element 'Count' is described within the video [Count, Length and Area Measurements](#) . You'll see the placement of points that make up a count and also a brief explanation of why such measurement can be valuable.

## Length Element

---

The length element allows you to measure distances on the site as well as record assets that have a length property such as kerbs and fences. Lengths elements can be closed to measure perimeters. It is worth noting that all earthworks elements report a boundary outline perimeter in the input data summary so there is no need to trace a line around any earthworks element.

The properties that are exposed for the length element are summarised below.

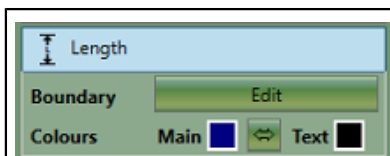

- **Boundary**

Boundary button provides access to the editor wherein the definition points can be defined for the points which define the area.

**Note:** The 'Closed Line' state (whether to add an extra segment connecting the start and end points) can be changed here too

- **Colours**

Here you can set the Main and Text colour of the length. This can be useful for visually separating different Length measurements or making them easier to see against the colours of the topography.



Measurement element 'Length' is described in the video [Count, Length and Area Measurements](#). This tool allows you to measure between two positions.

## Area Element

The area element is used for measuring areas in the project. Areas of earthworks disturbance are recorded in the earthworks estimation summary so there is no need to measure these. Area elements only measure 2D areas, as if they were measured from a paper plan. They don't measure the 3D surface area that can be found in the earthworks estimation report.

The properties that are exposed for the area element are summarised below.

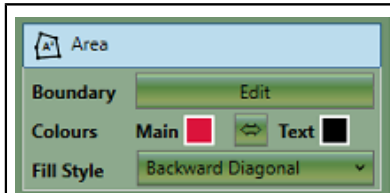

- **Boundary**

Boundary button provides access to the editor wherein the definition points can be defined for the points which define the area.

- **Colours**

Here you can set the Main and Text colour of the area element. This can be useful for visually separating different area measurements or making them easier to see against the colours of the topography.

- **Fill Style**

The fill style allows you to fill in the area with different styles of hatching. This can also be used to visually separate different area measurements in your project. You can set the fill style to none if you only want to see the boundary lines of the measurement.



'Area' is the last measurement tool in the video [Count, Length and Area Measurements](#). You'll see how to draw the area boundary and use colour hatching to distinguish it from other measurements.

## Volume Region Element

The volume region element is used for reporting cut\fill in different regions of a particular phase. It is worth noting that there is no requirement to have any volume regions in a phase. If there are none defined the earthworks estimation report will still show a breakdown by element and results for all earthworks in the phase.

Intersecting regions are not allowed. This is to avoid the potential confusion caused by cut\fill volumes being counted multiple times in the same breakdown. A region within a region will be handled by first calculating the outer region excluding the inner region and then calculating the inner region separately. Any areas not enclosed by a region will be listed under 'remainder'.

The properties that are exposed for the region element are summarised below.

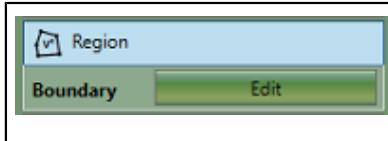

- **Boundary**

Boundary button provides access to the editor wherein the definition points can be defined for the points which define the area.



In this video about the element [Volume Region Measurements](#), you'll learn about drawing valid volume regions and how they are reported in the spreadsheet export.

## Cross Section Element

The Cross Section element is used for visualising a slice cut through the terrain, and displaying both the existing and the proposed layers. The Cross Section can be viewed in the software, and also will be presented in exports.

The properties that are exposed for the Cross Section element are summarised below.

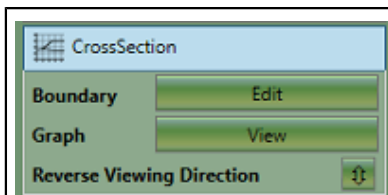

- **Boundary**

Boundary button provides access to the editor wherein the definition points can be defined for the points which define the cross section.

- **View**

You can click this button to view the cross section.

- **Reverse Direction**

The direction that the cross section is viewing will be indicated by the section arrows on the screen. You can reverse the direction by clicking this button.

When you click on the View button, a screen will open like that one shown below. You can use the mouse to zoom in and out and pan around this section. As you move the mouse, the levels, and the cut/fill will be presented by the cursor. It is worth noting that the sections presented in this view will use the vertical exaggeration from the main window. If you find the section difficult to visualise because it is too flat, you can increase the vertical exaggeration before viewing the section.

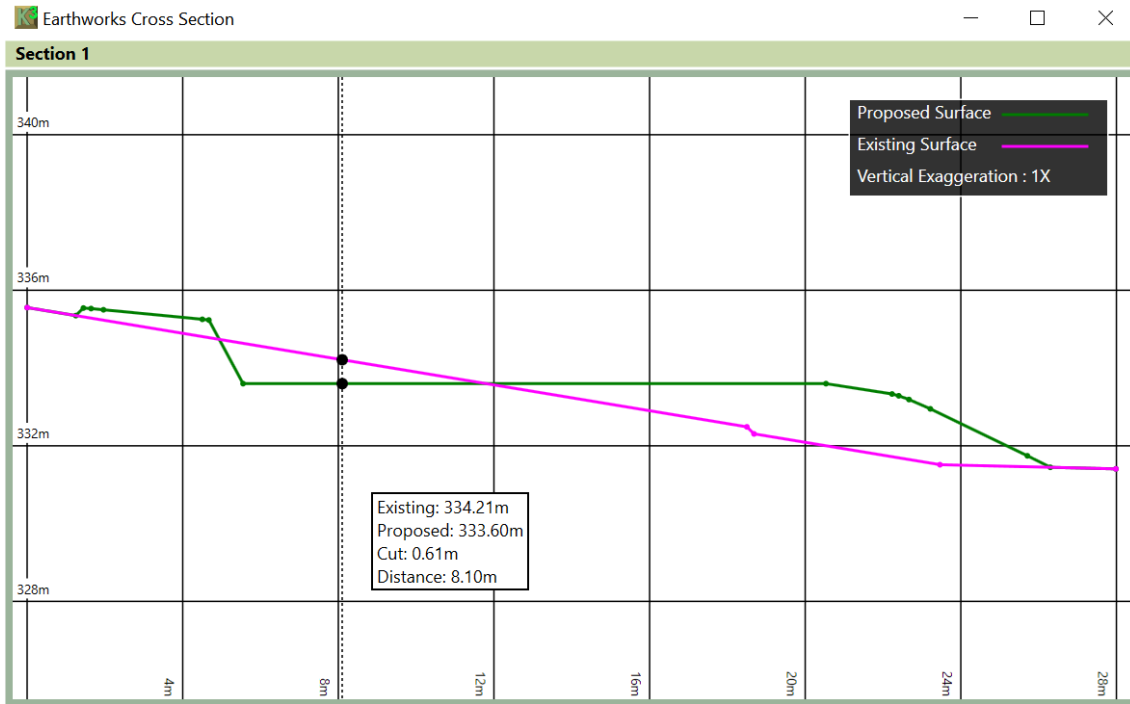

[Measurements - Cross Sections](#) shows you how to draw long sections and cross sections across a phase, before highlighting various viewing and export options.





---

# Chapter 7

---

## Editing Elements

---

### Topics:

- [Feature Types](#)
- [Adding New Features](#)
- [Adding Features Manually](#)
- [Adding Features from a PDF/  
CAD File](#)
- [Adding Points from a Data File](#)
- [Editing and Deleting Features](#)
- [Triangle Surface](#)
- [Editing Tools](#)





**NOTE:** Elements can be edited in Pop-In or Pop-Out mode. For an explanation of these modes see [Editing Modes](#).

With the exception of the Triangle Surface, all elements are defined by a collection of elevation features, drawn manually or loaded from a file (e.g. CAD). The four elevation features are: outlines, contour-lines, break-lines, survey-points, or a combination but always in that order.

After an introduction to the feature types (outlines, contours, breaks and points) the remainder of the chapter covers how to import data, create it manually and also update/edit.

## Feature Types

The elevation features may be named differently within some elements, however they have the same behaviours and are recognisable by their icon and order. The feature surface has all four types of data, which makes it suitable as a base example. Any combination of the following terrain features (where available) can be used to define the terrain:

	<p><b>Outlines</b></p> <p>This element is used to define the outline(s) of the feature surface. There will almost always be only one outline, but it is possible to define more than one to create several 'islands' of terrain. It is also possible to create holes in the terrain by adding internal outlines.</p> <p>There are also different types of Outline:</p> <ul style="list-style-type: none"> <li>• <i>i) Extrapolate from other Features (Default):</i> Takes the levels from contained elevation features that you have defined (e.g. contour lines and points).</li> <li>• <i>ii) Define Varying Levels:</i> Allows you to set levels for the outline which vary at each point. This can be used if you need maximum control of the surface outline elevations.</li> <li>• <i>iii) Define Fixed Level:</i> Allows you to set a single level for the outline, this is only used in very unique scenarios.</li> <li>• <i>iv) Use Ground Levels:</i> Snaps the Outline elevations to the ground. (This can only be used with a feature surface used to define proposed earthworks)</li> </ul>
	<p><b>Contour Lines</b></p> <p>Contour lines (or isolines) are used to define lines on the terrain with a fixed elevation</p>
	<p><b>Break Lines</b></p> <p>Break lines are used to defined lines on the terrain which have a varying elevation</p>
	<p><b>Point Levels</b></p> <p>Point levels are used to define the levels for individual points in the terrain area</p>

The properties of each feature vary depending on the feature type, but they all have a 'Tag' which can optionally be set. This is an identifier for the feature (akin to the feature's name), and it is used to help the user identify particular features.

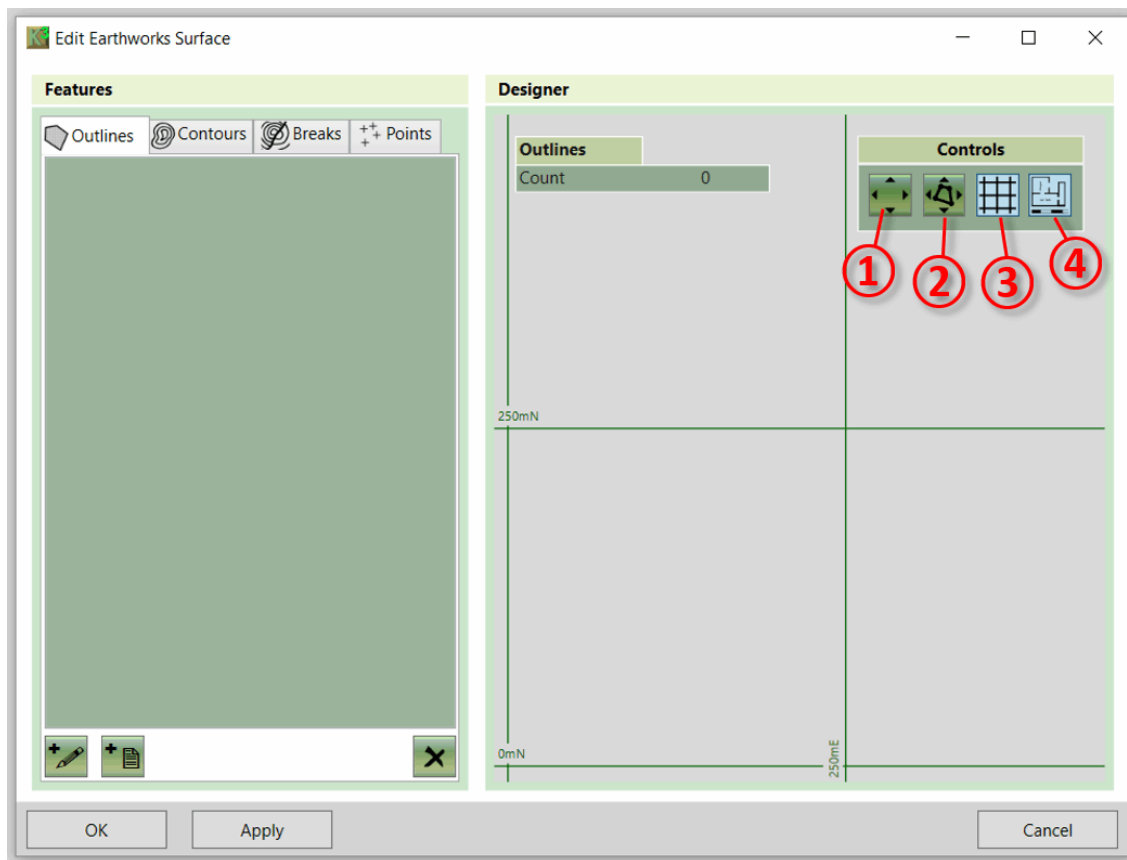

This form includes three display buttons as described below:

- ① Zoom to Extents This button zooms to designer to extents (i.e. frames all elements in the designer panel)
- ② Zoom to Selection This button zooms to designer to selected features
- ③ Toggle Grid This button toggles the grid in the designer on and off.
- ④ Toggle Site Plan This button toggles the site plan in the designer on and off.

The rest of the controls on this form are used to add, remove and edit the terrain features. They are described in detail in the following sections.



Learn how to define boundary outlines in the video [Understanding Feature Surface Outlines](#)

## Adding New Features

Terrain features can be added either by drawing them manually on the designer screen, or by loading them in from a file. Outlines, Contour Lines and Break Lines can be loaded from PDFs (with vector data) and CAD files (.dwg, .dxf) whereas Point Levels can be loaded from either a PDF (with vector data) CAD, or from an excel or text data file.

To add a new feature select the feature type that you want to create ① and then click either Add Manually ② or Add from File ③.

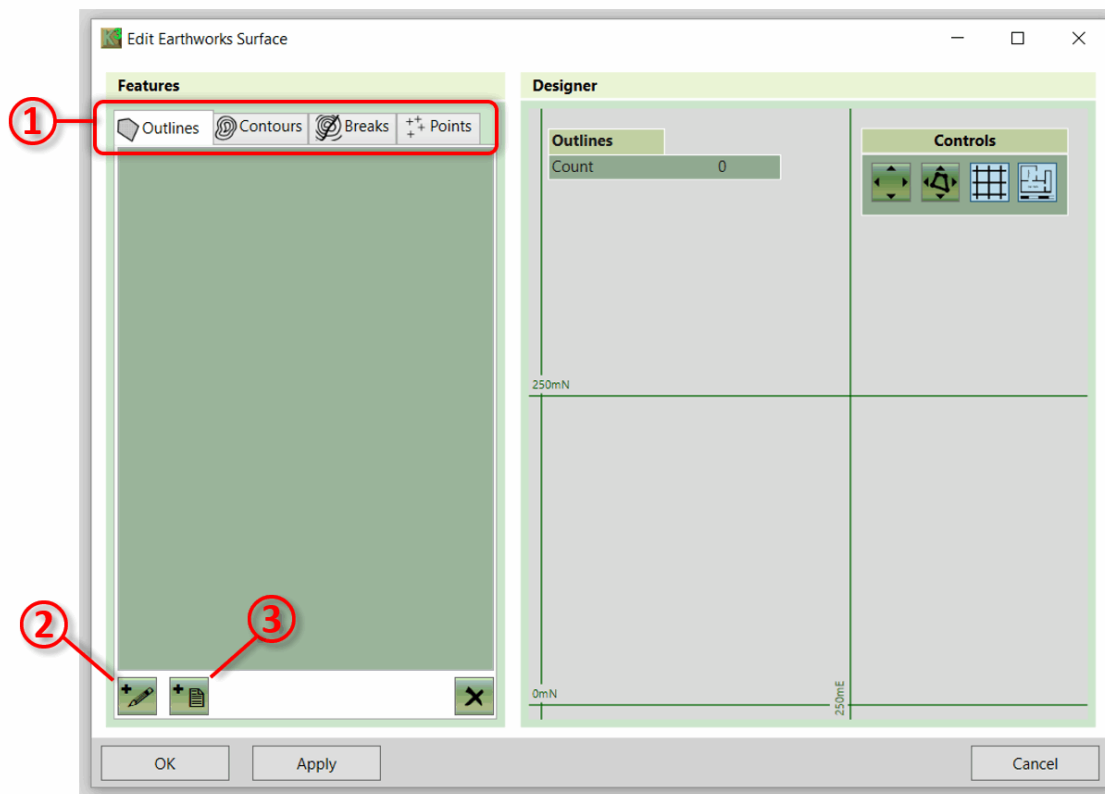

If you add a feature from file you will be prompted to select the file to open. The process to follow after this is described in the following sections.

## Adding Features Manually

The process once you have clicked on the button to add a new feature manually depends on the type of feature you have selected. In all cases you draw the elements on the designer panel on the right of the screen.

- **Outlines**

When you choose to add an outline the following prompt will appear, providing two options to create outlines.

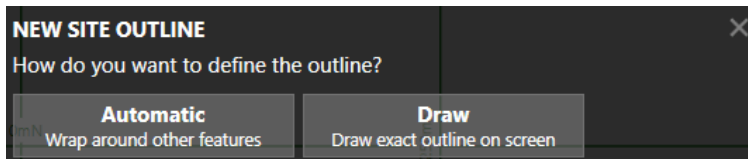

- **Automatic outline.** If you choose this option the software will automatically create outlines, based on the features that you have defined. This process is analogous to wrapping a rubber band around the features that

you have already defined to create an outline. You will be able to adjust how much this 'rubber band' is 'sucked in'.

- **Draw.** If you choose this option you will draw an exact outline on the screen. You will be provided with a number of options to set the levels for this outline:
  1. *i) Extrapolate from other Features (Default):* Takes the levels from nearby elevation features that you have defined (e.g. contour lines and points).
  2. *ii) Define Varying Levels:* Allows you to set levels for the outline which vary at each point. This can be used if you need maximum control of the surface outline elevations.
  3. *iii) Define Fixed Level:* Allows you to set a single level for the outline, this is only used in very unique scenarios.
  4. *iv) Use Ground Levels:* Snaps the Outline elevations to the ground (This can only be used with a feature surface used to define proposed earthworks)

When you choose you preferred option follow the steps to completed the outline. Once you have finished you will see the prompt below.

The screenshot shows a dark-themed dialog box titled "NEW SITE OUTLINE" with a close button (X) in the top right corner. Below the title, the coordinates "X: -9.01mE, Y: 90.09mN" are displayed. There is a "Tag" label followed by a white input field. To the right of the input field are two buttons: "Next" and "Finish".

You can define a Tag for the Outline if you wish. Click Next to draw another Outline, or Finish to stop drawing Outlines.

- **Contour Lines**

Draw each point of the Contour Line by left clicking on the designer panel. Finish drawing the contour by right clicking, or by pressing the enter key. The following prompt will appear:

The screenshot shows a dark-themed dialog box titled "NEW CONTOUR LINE" with a close button (X) in the top right corner. Below the title, there is a "Tag" label followed by a white input field. Below that is a "Level" label followed by a white input field with a red border and the unit "m". To the right of the "Level" input field is a "Closed" checkbox. To the right of the "Closed" checkbox are two buttons: "Next" and "Finish".

You should type the level for the Contour Line into this prompt. You can also define a Tag if you wish. Lastly if the Contour Line is a closed loop you can click the Closed checkbox. Click Next to draw another Contour Line or Finish to stop drawing Contour Lines. Note that the '...' before the 'Level' input box can be used to adjust the levels you type. E.g. if all of your levels start from an elevation of 1000 you can click on '...' and input '1000+'. You can then type, for example '26' into levels box and this will be converted into '1026'. This can save time in some take-off scenarios.

- **Break Lines**

When you choose to add a breakline, you will be prompted to click on the designer panel to define the first point position. Once you have done this you will see the following prompt.

You can define a level (Z) for the Break Line point and can also type precise X and Y values if you wish. If you prefer, you can skip typing the level and the software will interpolate it. This is useful if you have a detailed break shape where the levels are only defined at a few locations.

If you leave point levels blank, the software will fill them in with the following logic:

- Wherever the Break Line crosses another line (e.g. a contour) a point will be added to the Break Line with the same level as the crossing line.
- When crossing line points have been added, linear interpolation will be used along the Break Line to fill in any missing levels.

Click Continue to draw another breakline point or Complete to finish drawing the Break Line.

Once you have finished drawing a Break Line the following prompt will appear:

You can also define a Tag for the new Break Line if you wish. If the Break Line is a closed loop you can click the Closed checkbox. Click Next to draw another Break Line or Finish to stop drawing Break Lines.

- **Point Levels**

Draw the Point Level by left clicking on the designer panel. The following prompt will appear:

You should type the level for the Point Level into this prompt. You can also type X and Y values for precise positioning. If you wish, you can type a Tag for the Point Level. Click Next to draw another Point Level or Finish to stop drawing Point Levels. Note the comment on 'Contour Lines' above regarding the '...' in front of the level input box.

## Adding Features from a PDF/CAD File

Once you have selected a CAD (.dxf, .dwg) file or vector PDF, the following window will appear. Note that this window will only display the features that can be interpreted as a feature type you have selected. i.e.

- **Outlines:** Only closed lines will be displayed
- **Contour Lines:** Only lines will be displayed
- **Break Lines:** Only lines will be displayed
- **Points:** Only points will be displayed

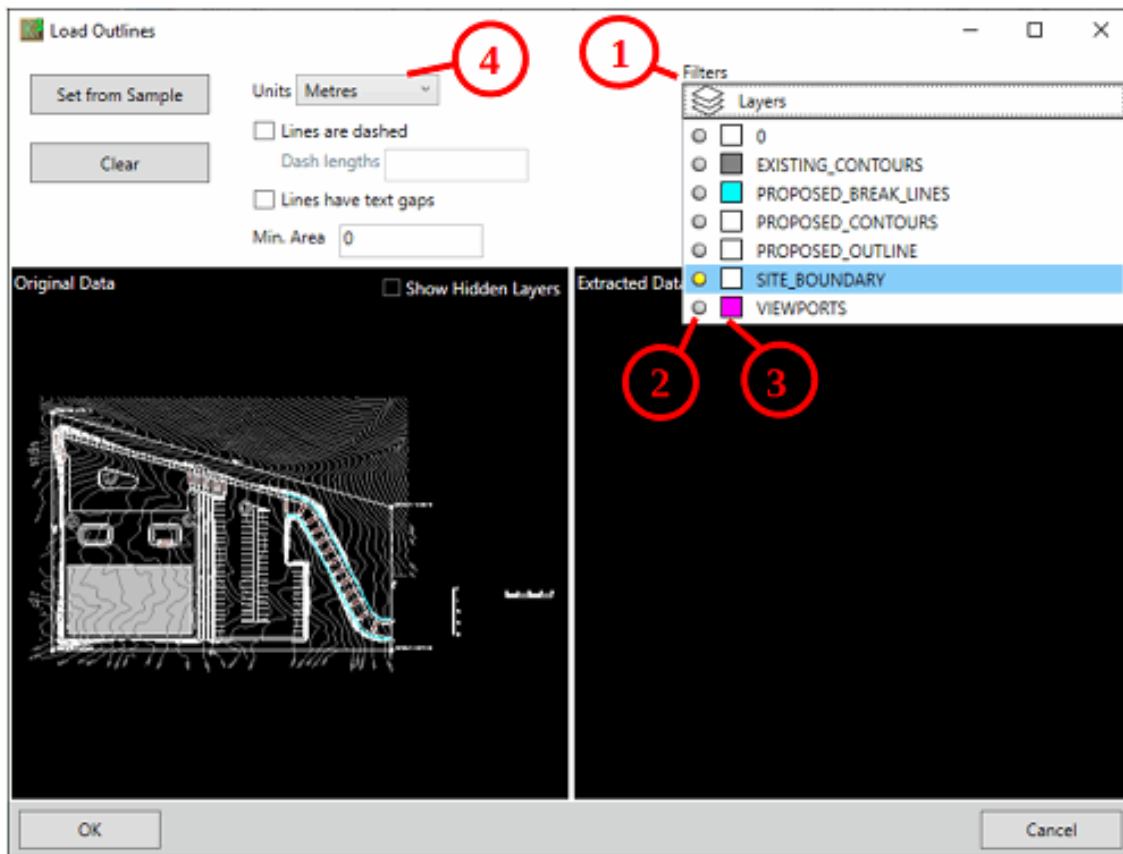

You can inspect the layers in the file by clicking on the Layers Bar ①. You can toggle each layer on and off ②. Layers which have been turned off will not be imported. You can also change the colour of layers by clicking in the colour box ③. This is purely to help identify different layers in this window, and the changes you make will not be saved into the CAD/PDF file.

The other important setting is the units of the file which can be chosen from the drop-down ④. By default, the units are set to metres if the CAD/PDF file's 'insertion units' are metric and to feet if they are imperial (English units).

**Note:** The 'insertion units' variable is often set incorrectly when CAD files are saved; it is important to check the value, is as you expect.



Learn how to import contours, points and a poly-face mesh in our [Working with CAD Data \(.dxf, .dwg, .dgn\)](#) video, which also covers CAD export.

## Adding Points from a Data File

Once you have selected an excel or text file the following window will appear. In the case of an excel file, the 'File Format' section will not appear, as this is only used for defining text file formats.

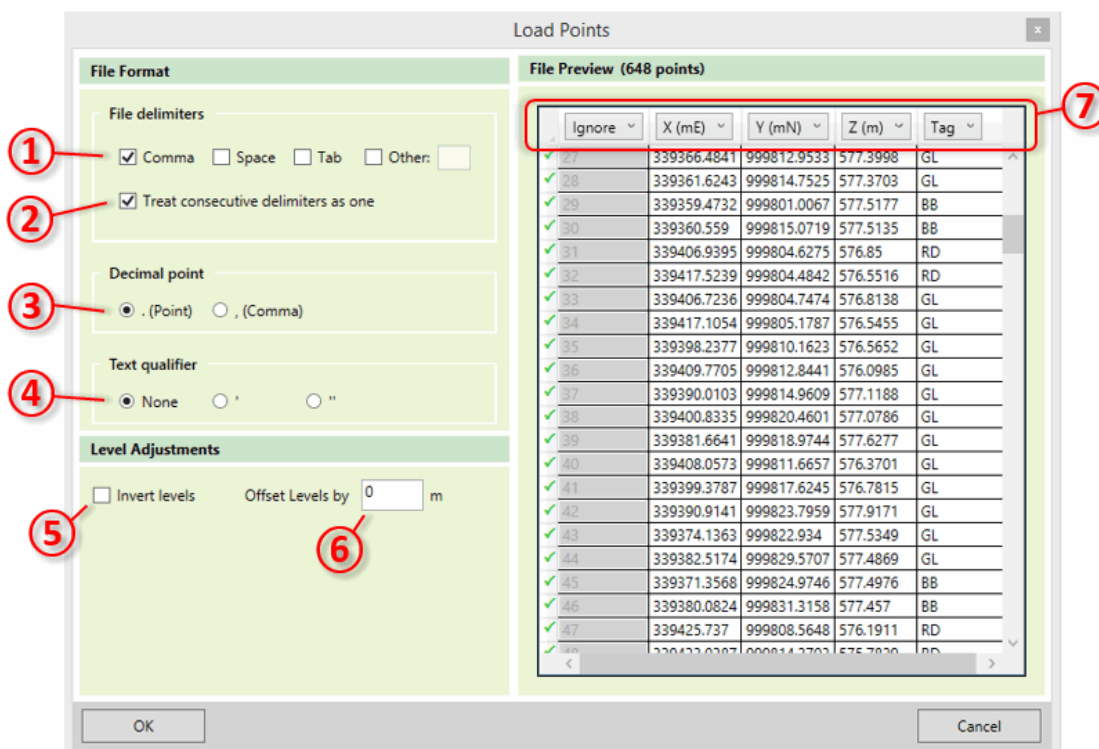

If you are using a text file it is necessary to define the file format with the controls on the left. In many cases the file will immediately show correctly in the previewer. However, if you have an unusual file format you may need to amend the details of the file format on the right side as follows:

- ① File delimiters Specify what character is used to delimit the fields in your file. Files are typically tab, comma or space delimited, but any character can be specified here by clicking Other and typing in the text box.
- ② Treat consecutive delimiters as one Specify whether several consecutive delimiters in a file line should be treated as one, or if these should be treated as several fields with empty values.
- ③ Decimal Point Specifies whether your file uses a point or a comma to denote a decimal point. This is used to deal with different conventions in different parts of the world.
- ④ Text Qualifier Specifies the character that is used on either side of a text field in the file, if your file contains text fields.

There are also some controls which can be used to adjust the levels (Z values) in the file:

- ⑤ Offset Levels by - If the points in your file are offset from the vertical datum you want to use then you can specify it here.
- ⑥ Invert Levels - *Kubla Cubed* uses upwards-positive convention for levels. If your file uses upwards-negative convention, then you can use this option to invert the values in your file so that they are suitable for *Kubla Cubed*. This option is mostly used for hydrographic surveys, which often report depths as positive values.

Finally, you must specify which columns in your file represent the X, Y, Z and Tag (if it contains tags) values for the data. This is done by clicking on the column header in the data preview ⑦ and selecting 'X', 'Y', 'Z' or 'Tag' from the drop-down. You can also specify 'Ignore' if that column contains data which is not relevant.



In the video [Importing Point Files \(.xyz, .csv, .xls\)](#) we look at importing point files into *Kubla Cubed*. Point files can be used to define both the existing and proposed terrain by using a feature surface.



## Editing and Deleting Features

Features can be selected in two ways - either by clicking the element on the list to the left of the window, or by clicking on the feature in the designer panel. Note that only the current feature type is selectable in the designer panel. E.g. in the example shown below only contour lines ① are selectable in the designer panel.

Multiple elements can be selected by holding down the shift key and clicking on several items.

Once features have been selected, they can be deleted by clicking on the Remove ② button.

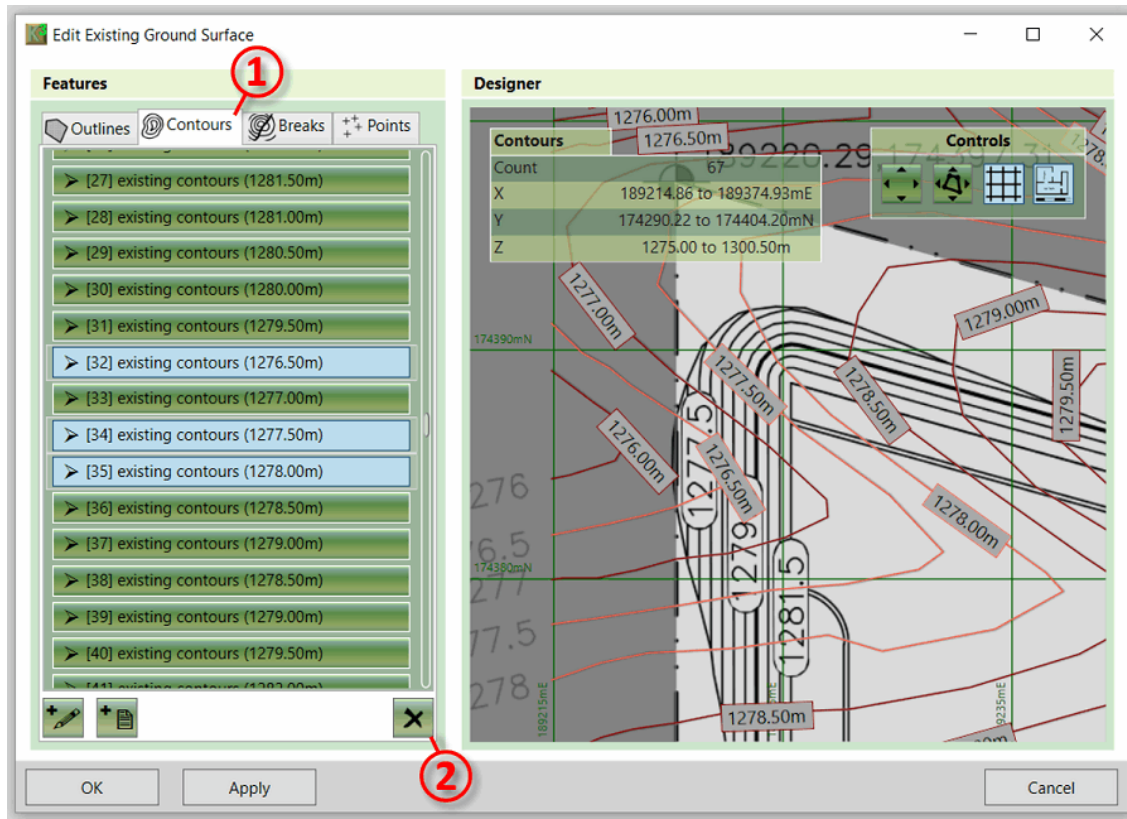

A feature can be edited by double-clicking on it in the side bar or designer panel. When you do this the feature will be expanded in the side bar, exposing its properties so that you can change them. You can now edit this feature, either by typing new values into the side panel or by dragging points and lines in the designer panel ②. Points can be added to or removed from lines by clicking on the ± button in the table ①.

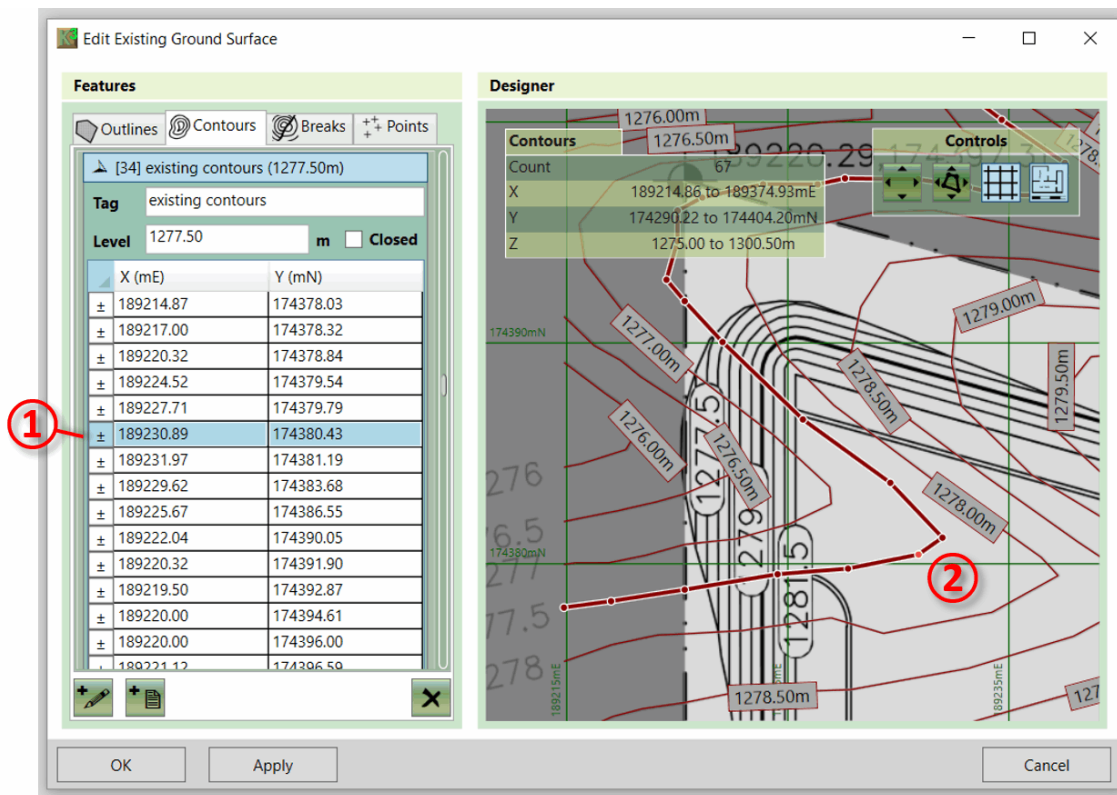

## Triangle Surface

The triangle surface is defined by a group of interconnected triangles. You cannot define these triangles manually; instead they need to be imported from a program that works with triangulated models sometimes. The surfaces are sometimes referred to as Triangulated Irregular Networks (TIN), triangulations, polyface meshes and Digital Terrain Models (DTM).

The triangulations can be imported from CAD files (.dwg, .dxf), LandXML (.xml) files and Kubla Project files (.kcp). When importing from CAD files you need to select the layer that contains the polyface mesh objects, the polyface mesh objects in the selected layer will then all be merged together and imported as a single object. The LandXML and Kubla files work slightly differently as they do not have layers, instead you need to select the specific name of the surface you wish to import.

Load Triangle Surface from File

**File Path**

Choose the file that you want to open

C:\Users\mebwo\Desktop\Building Site Example Metric Units.xml

**Surfaces**

Choose the surface to load

Existing

Phase 1

OK Cancel

This form includes two sections:

- ① Select File Here you select the file that contains the triangulation you wish to import.
- ② Select Layer\Surface In this section you select the layer (with CAD files) or surface with LandXML and Kubla Project files.

**Note:** If you are loading from a CAD (.dwg, .dxf) file this form will also have a 'units' drop-down. This is required because the units are not saved in the .dxf format, so you need to specify them when loading the file



The video [Existing Levels - Triangle Surface](#) provides a comprehensive study of the Triangle Surface and how to import triangle data.

## Editing Tools

Line editing tools assist with the definition of lines, availability is dependent on the element being edited and the type of feature used within. They are accessible from within the element editor in the bottom left corner.

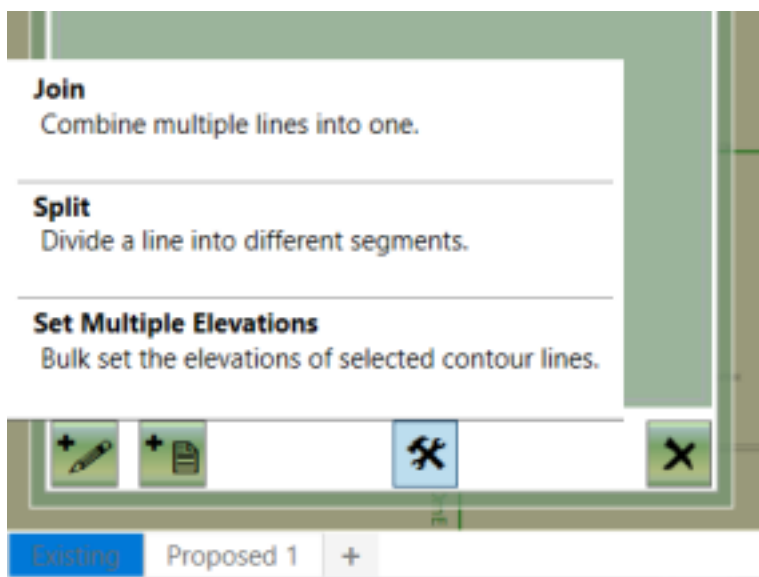

## Set Multiple Elevation (SME) Tool

Contour lines (or isolines) are used to define lines on the terrain with a fixed elevation.

When tracing contour lines manually, a fixed elevation is added after completing the line. However, when extracting contours from a PDF or import from a flattened CAD file, there are no Z (level) values within the data, therefore you need to add these elevations. It is acknowledged that this can be time consuming, so the SME tool was built to set the elevations of a group of contour lines, which should make the process considerably faster!

The SME tool works quite differently from the Join and Split with regards to selection. With the SME tool chosen from the menu, place a point just before the first line to be included. Then move the mouse and subsequently place a second point beyond the first and second line in the range. Then either right click to finish or continue moving and clicking to add a multi point line. Where the line is drawn will identify the lines to be included. Once the range line has been created (after right click) the start elevation, contour interval and slope direction (ascending/descending) can be set. Once these values have been edited as required, press 'Continue'. A preview will then highlight the contours lines with a gradient green shading to highlight the elevation differences. If the preview is acceptable, press 'Finish' to accept the proposed changes.

1. Select the SME tool from the menu
2. Define the Range: Using your mouse left button, draw a line from just before the first contour, to the final contour, and ensure your line is intersecting all of the contours that are in the group you want to set. Lift the left button and then press down again if you want to have a range line that is not straight
3. Right click to finish the line.
4. Set the 'Start' (elevation value of the first contour line) e.g. 200. Then add the 'Contour Interval' (difference between each contour e.g. 1) and choose whether difference is ascending or descending.
5. Press 'Finish' button

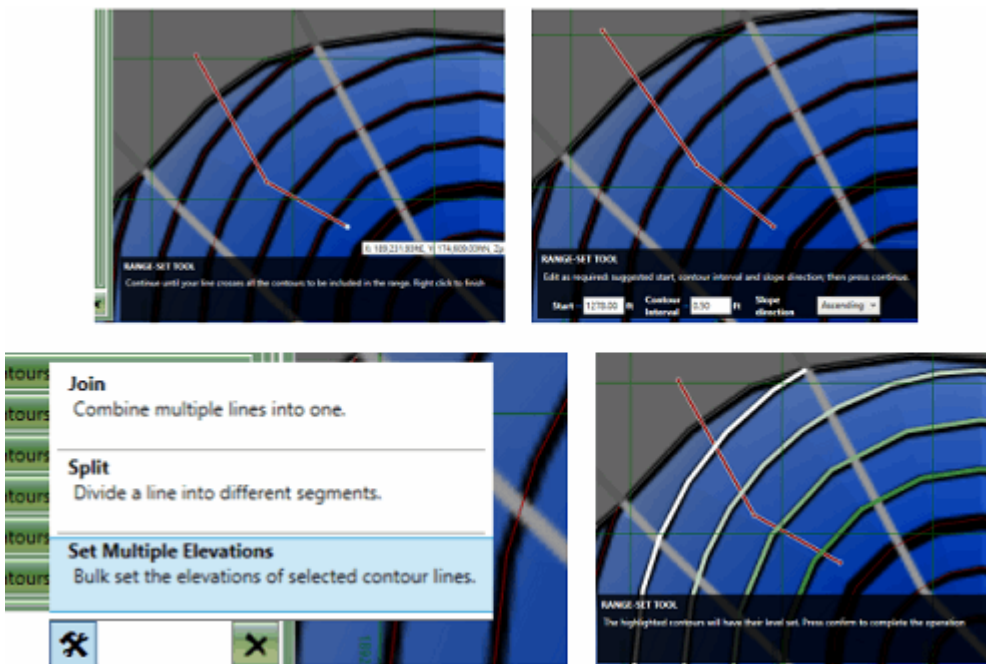

Above (clockwise from bottom left): SME tool location, drawing the range, accepting/editing defaults, preview of changes.

Closed lines **are** supported. If the operation needs to be cancelled, click on the 'X' in the top right of the black strip along the bottom, will cancel the SME operation.

Defaults for the Starting elevation, contour interval and whether the slope is ascending/descending are set based on the first two contour lines under the selection.



[Set Multiple Elevations \(Contours\)](#) This video shows you how to use the Set Multiple Elevations (SME) tool in Kubla Cubed to set your contour elevations quickly and easily.

## Offset Tool

The Offset Tool is used to create a new line which is placed at a user specified offset (relative distance and relative elevation) from the original line. The user is also prompted to enter a point, to identify which side of the original line to place the offset. The elevation is a relative Z axis adjustment, while the distance is for the XY plane. This is useful for creating footpaths around roads. The tool supports outlines, contours and break-lines.

Add at least one original line (via file imported data or drawn). Select the line from which to offset, from within the feature list window, or by selecting a line within the main window/model. Now select 'Offset' from the 'Tools' menu. The mouse icon will change to a cross-hair - this is a prompt for the user to point at which side of the original line to add the new offset line. The Wizard will subsequently prompt for relative *Distance* and relative *Z (Z Adjustment)*, from the original line. For example, original contour line elevation is 200m, so a Z adjustment of 20m will set the offset's elevation to 220m. The distance is how far the new offset line will be placed from the original selected line.

Once there is valid data inside the distance and Z adjustment inputs, a preview will display the offset line. The preview will continue to update after each change is made to the distance or Z adjustment (but you must deselect the input box for this to occur). Confirm changes by pressing 'Finish'. Pressing the 'X' in the wizard, will discard the offset.

1. Select the line from which to base the offset
2. Select the Offset tool from the bottom menu

3. When the mouse pointer changes to a cross-hair, single click near the original line, to signify which side of that line, to place the new offset line
4. In the wizard (appears after step 3) enter relative values for distance and Z adjustment; the preview will display after valid data has been entered and the user has deselected the input boxes
5. Check that the preview is indeed you want and update distance and z adjustment as required
6. Additionally, rounding of the corners can be adjusted via the slider. The default is *off*.
7. Press 'Finish' button

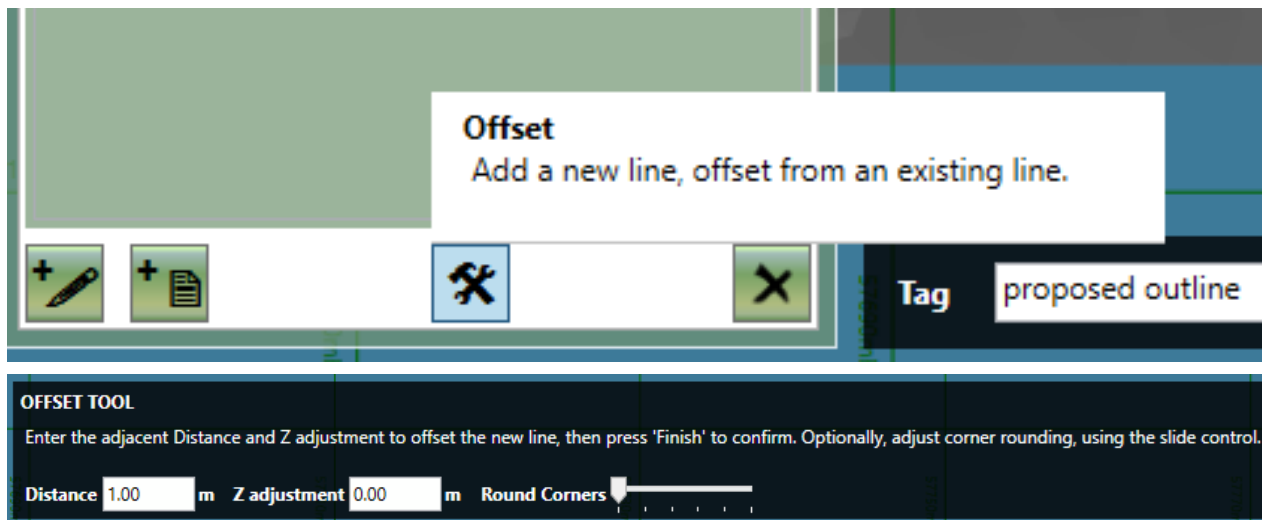

If the single click (with cross-hair) is within a closed line, then so too will the offset line, provided the distance entered, does not prevent a valid offset. In all other scenarios, the offset line will be outside the original. If the preview does not display the desired outcome, the Z adjustment and distance can be modified until the 'Finish' button is pressed. If the operation needs to be cancelled, clicking on the 'X' in the top right of the black strip along the bottom, will cancel the Offset operation.

## Split Tool

The Split Tool can split a break-line or contour line into multiple lines, at either selected points or selected lines. This is useful for editing lines that may have been incorrectly joined. When a segment is selected within the line to be split, the new lines generated will not include the selection. When a point is selected within the line to be split, the newly created lines will both have an end point at the split point.

After the lines have been added (via file imported data or drawn) select which line to be split. This can be done either by selecting a line from within the feature list window, or by selecting a line within the main window/model. A preview will display each new line in a different colour. The split can be confirmed or discarded by clicking the 'Finish' button or the 'X' in the wizard.

1. Select the line you wish to be split
2. Find and click the point or section of the line where the split is required (it will become highlighted)
3. Select the Split tool from the menu
4. Press 'Continue' button when ready to proceed
5. Check that the preview is indeed you want
6. Press 'Finish' button



Closed lines are not supported. If the line is closed, the split will fail and the validator will show an error message identifying what is incorrect. This is recoverable once the necessary selection change has been made; there is no need to start again. If the operation needs to be cancelled, click on the 'X' in the top right of the black strip along the bottom, will cancel the Split operation.

## Join Tool

The Join Tool can stick two or more contour break type lines together and supports joining multiple elevation features in one operation.

. This is useful for fixing contour line gaps, such as text label that have been imported from a CAD file. For contour lines, when more than one elevation is included within the selection, the highest elevation is chosen by default, alternatively this value can be edited.

After your lines have been added (via file imported data or drawn) the process involves selecting the lines that need to be connected, preview the planned join and then confirming.

1. Select the Join tool from the menu
2. Select the lines you wish to be joined
  - a. Select the first line you wish to join
  - b. Hold down the Ctrl key and select the second (third etc.) lines which you want to make into one line.
3. Press 'Continue' button when ready to proceed
4. Check that the preview is indeed you want (the lines will be joined and highlighted in green)
5. Check the level (contour type lines only) and edit as required
6. Press 'Finish' button

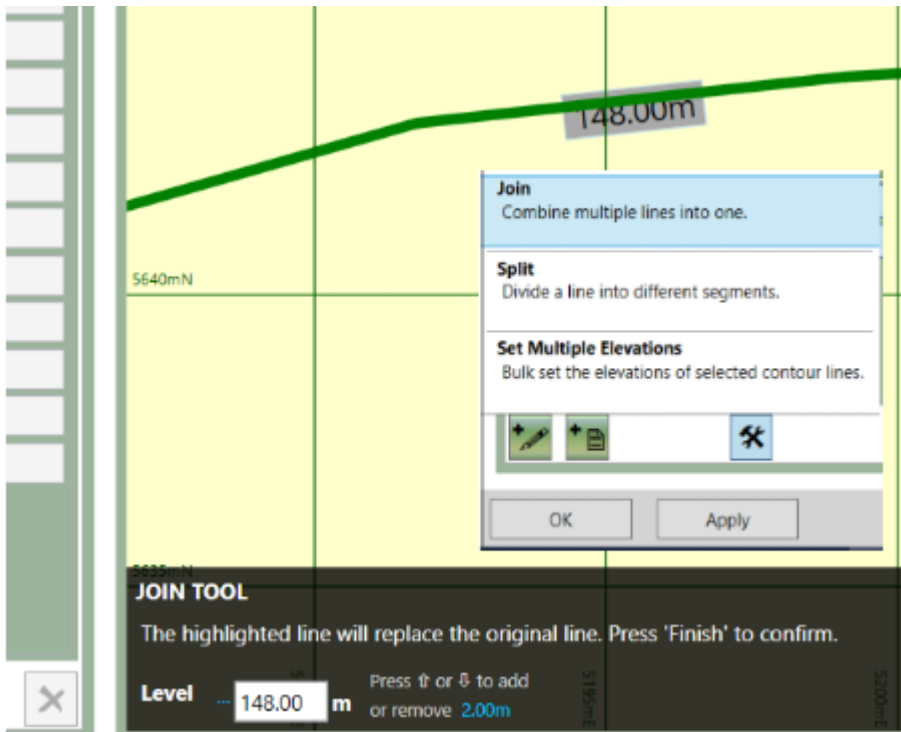

Above: Join tool in preview; inset the join tool selected as found in the tools menu.

If there is only one line selected, or if one or more of the lines is a closed line, the join will fail and the validator will show an error message identifying what is incorrect. This is recoverable once the necessary selection changes have been made; there is no need to start again. If the operation needs to be cancelled, clicking on the 'X' in the top right of the black strip along the bottom, will cancel the Join operation.



---

# Chapter

# 8

---

## Defining Existing Ground

---

### Topics:

- [Existing Defined with Points, Contour Lines and Break-Lines](#)
- [Existing Defined with Triangles](#)
- [Existing Boundary Outline](#)
- [Lidar and Photogrammetry data](#)

After importing and scaling site plans (if there are any) the next stage of a cut and fill project is to define the existing ground. Existing ground can be defined from a number of different sources. A simple stockpile project may involve importing the existing ground from survey points stored in a text file; a more complicated scenario could entail extracting existing contours from an embedded PDF file's vector data. Existing take-off can be very time consuming so it is worth using CAD data or extracting data from PDF vectors if at all possible.

Existing elevations are usually defined with contour lines or points. In this scenario the feature surface can be used to define your existing. If importing from a different project that supports the creation of TINS you can also use a Triangle Surface to import a TIN directly.

## Existing Defined with Points, Contour Lines and Break-Lines

Most existing surfaces are defined by points or contour lines. Break-lines are sometimes used in the existing to define hard edges along existing buildings, roads etc... Tracing elevations from a site plan is a work-flow that has been around since the very earliest volume estimating software. Early software required input from specialist digitisers and then later with on-screen take-off. It is still possible to trace existing elevations in this way and in fact is a skill that all users need to master. However with the right data there are much faster ways of defining existing by importing directly from files. Options for defining elevations in the existing are listed below with full descriptions following thereafter:

- Importing from Point Files (.xyz, .csv, .txt)
- Importing from CAD Files (.dwg, .dxf)
- Importing from PDF Vectors (.pdf)
- Tracing from Site Plans

### Importing from Point Files (xyz, csv, txt)

Point files are created during a topographic survey. They are a very simple format consisting of a text file with X,Y and Z co-ordinates separated by a special character (e.g. a comma). They can be imported into a Feature Surface by selecting the Point tab and selecting 'Add from File'. Using point files is very fast and accurate as the points are usually raw survey data. However the point files do not support break-lines meaning that detail in regard to hard edges cannot be imported efficiently.

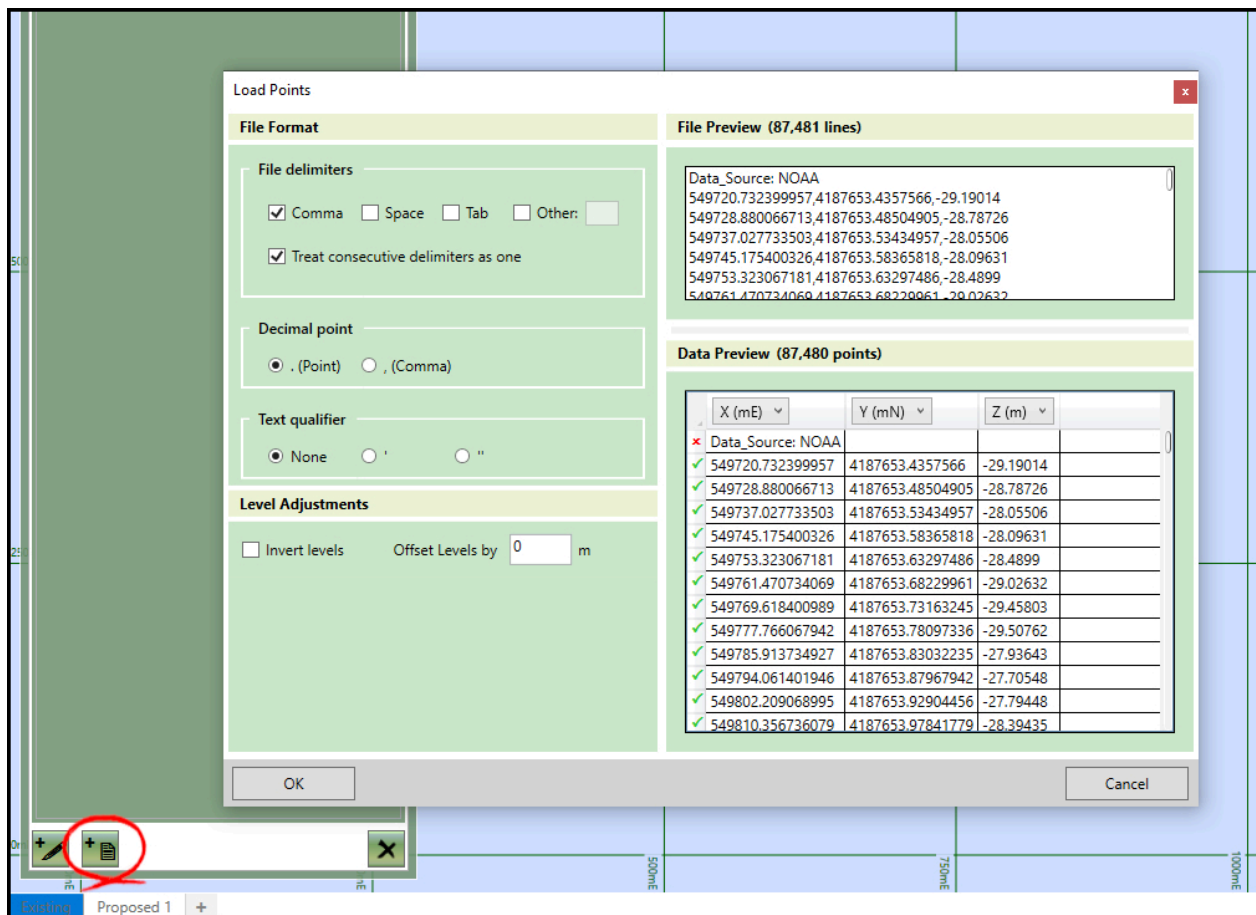

An existing surface being created from a point file

### Importing from CAD Files (.dwg, .dxf)

CAD files can contain all the necessary data to create a detailed surface in a few clicks. They can contain points, breaks, boundary outlines and contours. Within a CAD file you can logically separate different entities into different layers so you can have the contours in Proposed\_Contours and Existing\_Contours so it is easy to select what you need when importing. However just because a CAD file can contain a surface perfectly described with contour, points and breaks, there is no guarantee this will be the case. There can be many issues in a CAD file that make importing difficult. For instance, entities not being enclosed in a block, contours being represented by many dashes, or entities that do not contain Z values so they get imported at 0. There are many tools in Kubla Cubed to resolve these problems and in general a CAD file is usually the optimal file format to work with. However sometimes CAD data can take so long to process that it is easier to revert to tracing from the site plans.

### Importing from PDF Vectors (.pdf)

Unlike CAD files, PDF files do not contain technical meta-data and are a poor option for transferring geo-technical information. However their use in the industry is widespread, due in part that they can be read by anyone without a CAD software product. For this reason there is a benefit to being able to extract vector data directly from PDF files, as PDF files contain vector information. If this data can be extracted it can save a lot of time in tracing. The process to do this in Kubla Cubed is to first add the PDF file as a site plan and scale and position it as needed. This is because PDF are in printer space and need to be scaled before vectors are extracted. Once scaled, you can select which features you wish to extract (e.g. contours). Click on the 'Add from File' button: you can then select the embedded PDF and proceed to import entities the same way you would a CAD file.

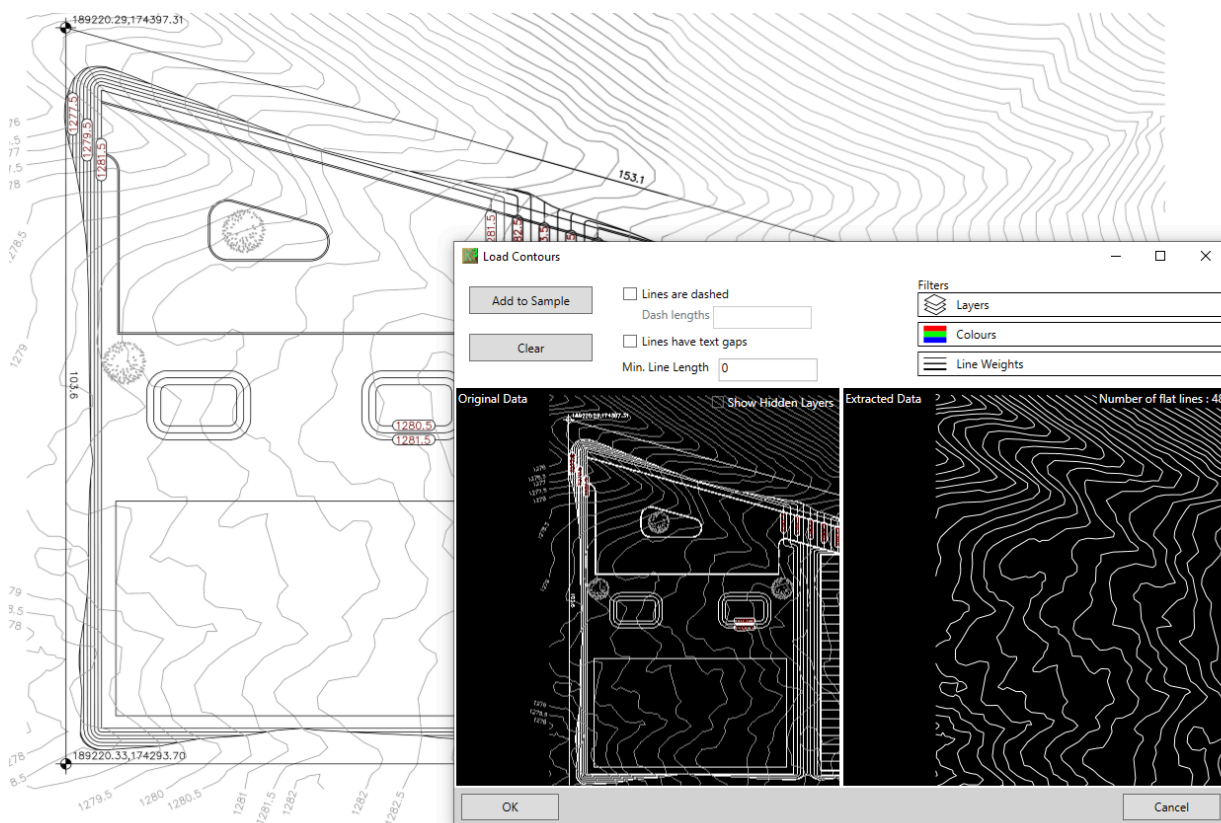

Contour lines being extracted from a vector PDF file

### Tracing from Site Plans

Tracing elevation features from site plans can be very slow, however there are some situations where there are no alternatives and so it can be used as the method of last resort. For instance if the site plan is a very poor quality scan or a CAD file does not contain data compatible with Kubla Cubed's data importer than tracing is a good alternative. As an estimator you can choose to be selective in regard to what data to trace. For instance if there are many contours you could decide to only take-off every other one or even just the major contours. However this decision comes down to the estimator's decision as to whether the increased accuracy of the extra data is worth the extra time in tracing it all.

## Existing Defined with Triangles

In Kubla Cubed it is possible to define an existing surface with triangles rather than with contour lines, points and break-lines. Typically you would do this if you had used another piece of software to define a TIN surface already and don't want to have to define the surface again in Kubla Cubed. You can also export TINs of any phase of Kubla Cubed to define as an existing surface of a new project. This allows you to break up very large projects or to compare different options in different projects.

With this approach you first add a Triangle Surface rather than a Feature Surface

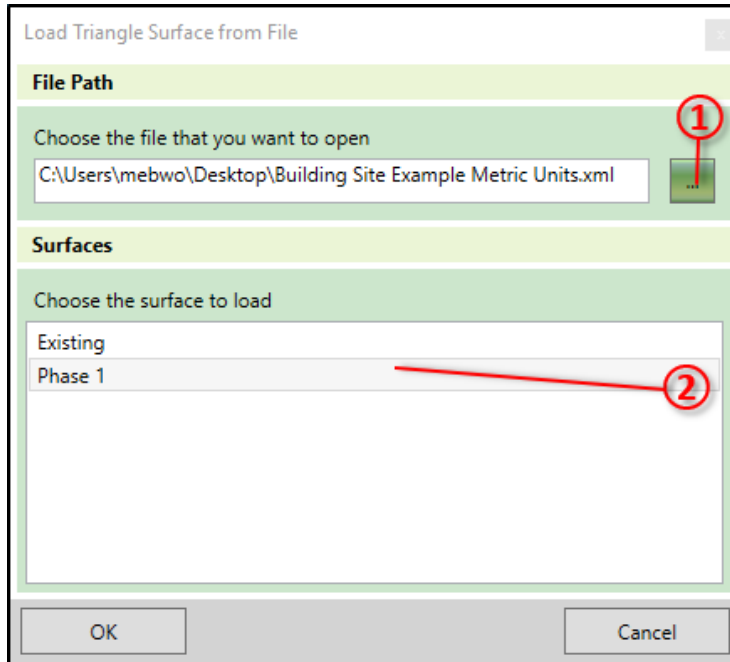

Triangle surfaces can be imported either from a TIN defined in a LandXML file (.xml) or a polyface mesh defined in a CAD file (.dwg, .dxf).



The video [Existing Levels - Triangle Surface](#) provides a comprehensive study of the Triangle Surface and how to import triangle data.

## Existing Boundary Outline

In a triangle surface the boundary of the site is derived from the boundary of the triangles. However when defining existing ground with a feature surface you need to define your own boundary. You can define a boundary with 'varying levels' whereby you input levels along the boundary outline yourself for maximum control alternatively a 'fixed level' can be used if all the levels along the boundary are the same. However, the outline type which is most frequently used is the 'extrapolate' outline which derives its elevations from the elevation features contained within.

When starting new projects it can seem like a good idea to define the existing boundary to the proposed area of disturbance. In other cut and fill software often there is one fixed boundary used by both the existing and proposed elevations however in Kubla Cubed there is a more sophisticated design. There is nothing wrong with this per se but it is not recommend. It is a bit similar to painting in that ideally you need a canvas that provides plenty of space for the painting subject, you don't need to cut the canvas closely to where you intend the painting to be. The disturbance area

of a Kubla Cubed project is controlled with the boundaries of the proposed elements not the existing and there are a number of reasons why having more existing surface than you need is advantages including:

- Visualisations look nicer if the proposed works are placed in context of the surrounding topography, rather than appearing to be floating in space.
- If the proposed design changes at a later date the existing boundary does not need to be amended to accommodate an expansion of the disturbance area.
- The extrapolate outline, as it is calculated not explicitly defined, sometimes needs to be corrected by adding elevation features inside the boundary. This is much easier to manage if the existing is larger than the proposed.

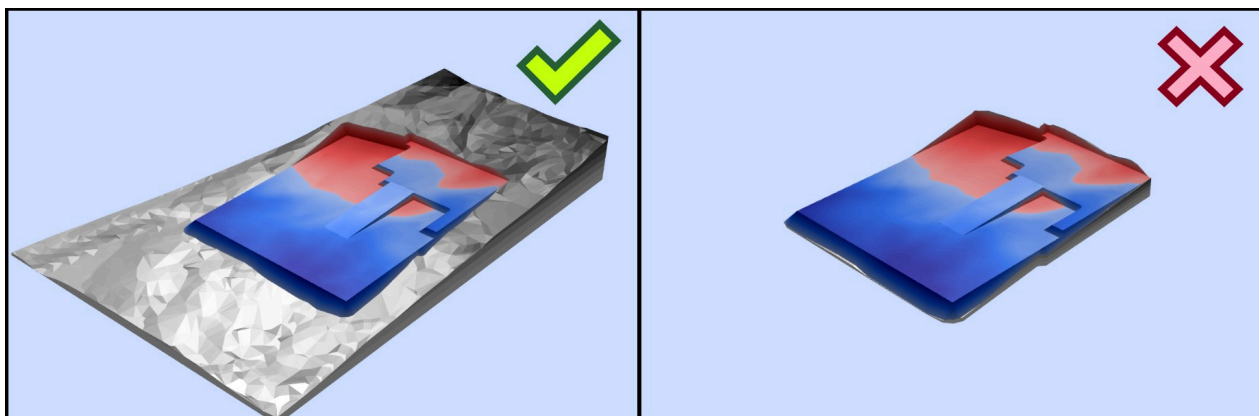

Existing with contextual data (left) compared to just the area of disturbance (right)

## Lidar and Photogrammetry data

The use of drones, aeroplanes and boats to capture topography is becoming more and more popular. As the cost and software/hardware improves the speed and accuracy these types of surveys provide is becoming increasingly compelling. Lidar (Light Detecting and Ranging) surveys use a laser to read the surface elevation. They are usually mounted on boats or aeroplanes and can penetrate through light foliage and water. Photogrammetry is frequently used by drones. The drones take 1000s of photographs of the site at different positions. These photographs are then loaded into a computer and by analysing the parallax effect of the images in a sequence an elevation surface can be generated.

Both these processes produce data that can be loaded into Kubla Cubed as a point cloud. The one problem is that the data sets tend to be very large in size often they can be 10 million points in size. Kubla Cubed uses can in theory convert this data into TINs and analyse the volume difference, however memory, graphics and processor limits will start to be hit therefore Kubla Cubed has a built in point reduction algorithm. If you import a large data set you will get a message asking you if you want to reduce the point cloud. If you select yes you will get the point thinner window, as shown below:

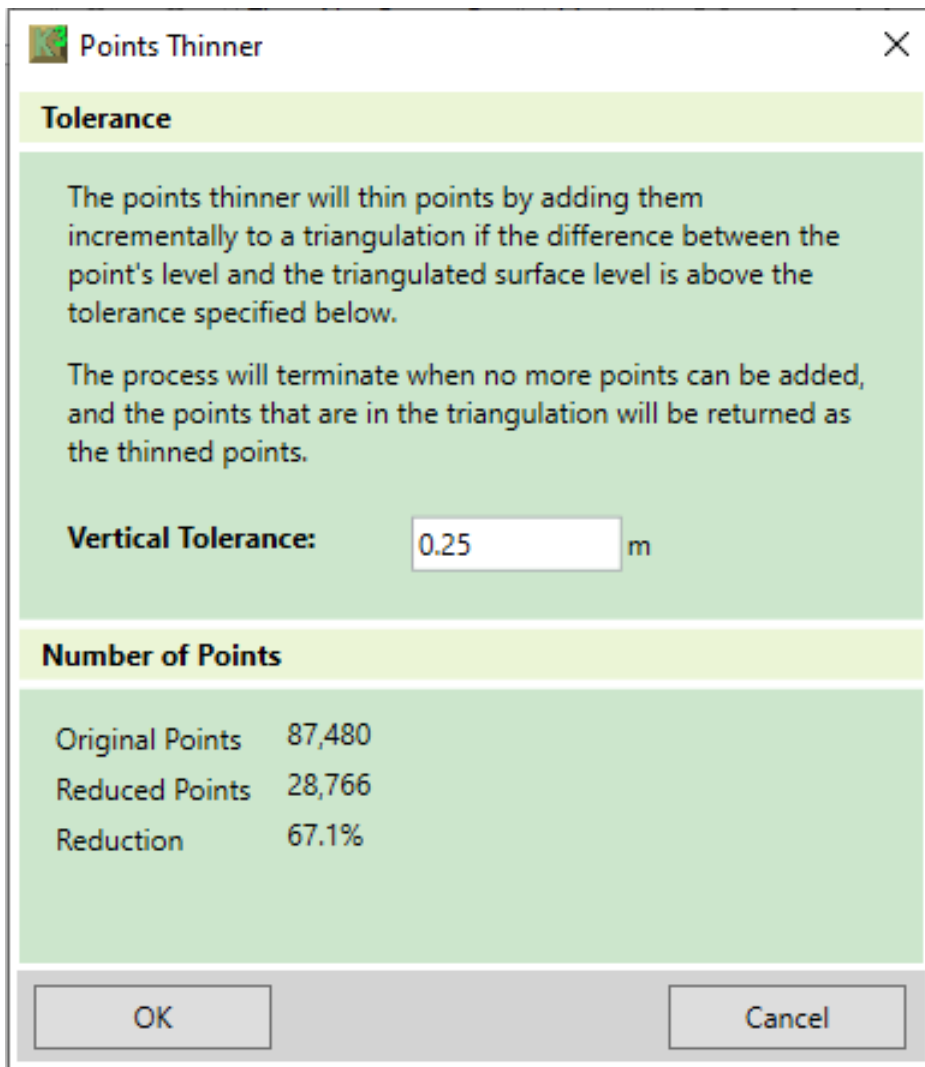

**Note:**

Currently it is recommended that the maximum point cloud at which the software becomes difficult to operate is 80,000 for a modern laptop and 150,000 for a modern desktop PC.

---

# Chapter

# 9

---

## Topsoil Stripping

---

### Topics:

- [Reducing a Topsoil Strip by Specified Depths](#)
- [Excluding Internal Areas from a Strip](#)

Often, at the beginning of an earthworks project, the first operation will be to strip the site of topsoil. Topsoil will typically contain a far higher level of organic material usually including a sod/turf layer; in an industrial context it will contain a higher level of contamination (nails, glass, oil etc...). It is removed separately for reasons of material reuse and soil stability.

A topsoil strip entails excavating an area by a set depth. For instance you may strip the entire site by 20cm. This is fairly easy to complete in Kubla Cubed with the 'Reduce Element'.

The two most important most important things to remember are to have:

1. Stripping calculation completed in its own distinct phase
2. Earthwork operations that are to be completed after the strip, defined in subsequent phases

There can be earthwork challenges including a requirement to reduce different areas by different amounts and to exclude internal areas from a strip (e.g. there is an existing building or tree on the site which is to be preserved). Within this chapter, we will look how Cubed can model both of these scenarios.

## Reducing a Topsoil Strip by Specified Depths

When you create a reduce element you either trace or import an outline and then set the depth value. Fundamentally this is all you need to complete a topsoil strip operation. If you want to strip the entire site you can just draw the boundary beyond the extents of the existing. This work-flow is not recommended however. We suggest having more existing that the disturbance area of your site as it produces better visualisations and it is easier to spot errors at the disturbance area boundaries.

If you want to complete strips in different areas a reduce element allows you to define multiple outlines as long as they do not intersect with each other. However a single strip element can only have a single depth value. If there is requirement is to strip different areas by different amounts then multiple strip elements should be used.

The side batter of topsoil strips are usually quite steep, so to reflect this it might be a good idea to adjust the side batter angle from the default of 1:1 to something like 1:0.2 or even turn it off completely depending.

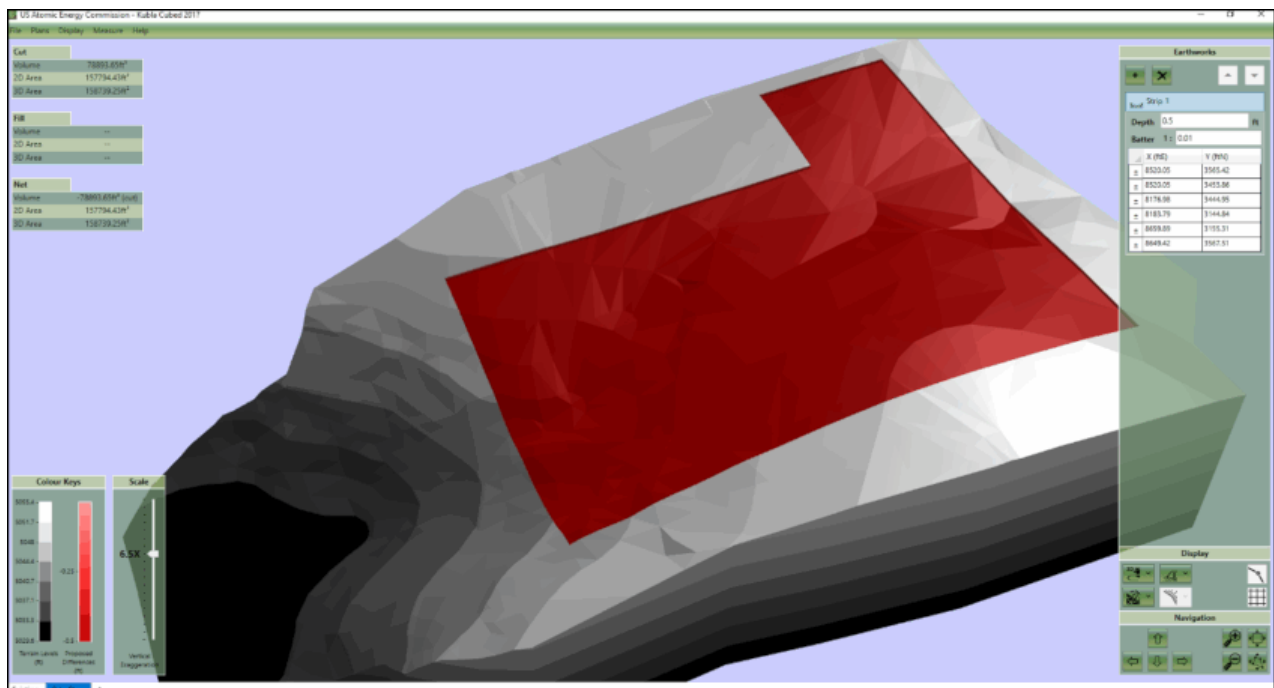

After the strip has been defined, it is worth reiterating that you need to create a new phase in order to calculate from the strip level to another level (e.g. formation/subgrade level). If you overlaid a Platform or Feature Surface over the top of the a strip in the same phase, the elevations from those elements would actually override the elevations of the strip. This is not what we want, we want those elevations to be calculated from the strip level so another phase is required to complete this operation.

### What Happens when Reduce Elements Intersect?

If Reduce elements overlap, they will override each other. Where they intersect the depth in the lower element in the calculation order will take precedence. This can be used to your advantage if there are two adjacent strip areas or an internal strip area. Rather than snapping the individual areas together you can override them and decide which depths are used in the intersecting areas by changing the calculation order. This works as a reduce element has the 'Depths From' property set to 'Ground' by default if there are no absolute elements above in the calculation order. It is not recommended to change these options from default or use absolute elements in a strip phase so the behaviour of reduce elements overriding each other is consistent.



## Excluding Internal Areas from a Strip

---

It is sometimes necessary to exclude internal region from a topsoil strip. This might be the case if there is a tree or an existing building foundation in the middle of the site. The suggested way of doing this is to edit a reduce element and create an outline within the outline that defines the boundary. The system will treat an internal outline as an inner boundary effectively 'punching out' the inner area and excluding it from the reduce operation. You can define as many exclusion areas as you need with additional outlines.

---



[Topsoil Stripping](#) looks at using the Reduce element to complete topsoil stripping operations and explains the importance of always having the strip depths defined on a different phase to subsequent earthwork elevations.

---



---

# Chapter 10

---

## Demolition

---

### Topics:

- [Breaking Out Concrete Areas](#)
- [Milling Paved Areas](#)
- [Calculating the Volume of Demolished Materials](#)

If a proposed construction project is taking place on a site which already has structures on it then a demolition phase may be required. If the project is taking place on empty land, then no demolition calculations are needed. Alternatively it might be that your projects existing levels have been surveyed post demolition so no calculation is required in that scenario either.

The vast majority of demolition estimating is outside the scope of a volumetric analysis program like Kubla Cubed, however the program can be useful in analysing certain activates where an estimation of volume is required. Even if those volume are not required it is important to complete the demolition phase in order for the existing elevations to be adjusted properly for use in calculating the volumes in subsequent phases. If you imagine a project where there is a 400mm thick concrete foundation that is to be removed during demolition, if you don't have a phase that reduces that level, subsequent phases that calculate over that area will be inaccurate as they will be calculating from the pre demolition level rather than post.

Demolition must be defined in its own phase. If earthworks elements are place over demolition areas in the same phase they can override the demolition levels effectively making the demolition elements redundant. Instead, demolition elements must be in their own phase so subsequent operations are calculated from the demolition level rather than overriding the level.

## Breaking Out Concrete Areas

Concrete areas will often need to be broken up and removed before building works can proceed. Usually this will be a matter of reducing the level down to a specific elevation. For this activity one or more platforms can be used to reduce to a fixed level.

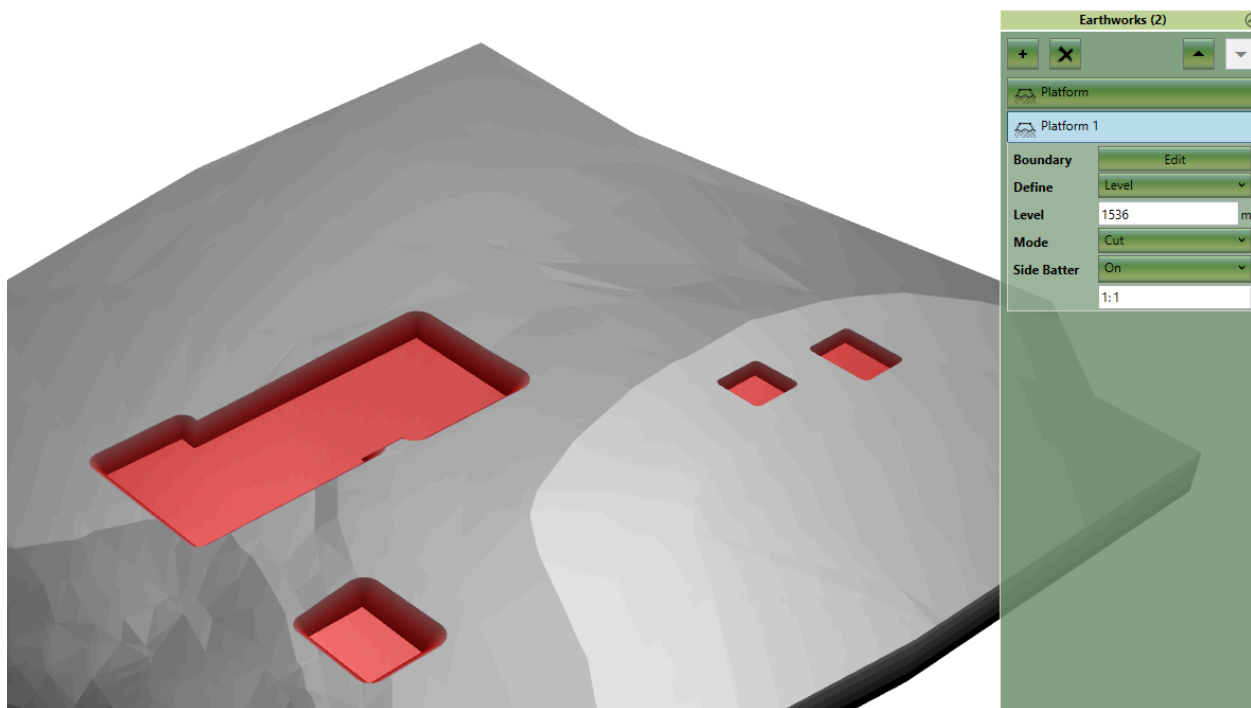

As this is an excavation only activity, it is worth setting the 'Mode' to 'Cut Only'. This means that the elements can only cut and not fill.

## Milling Paved Areas

A paved area can be milled to remove a surface layer, this could be so as to reuse this material somewhere else in the project or to reduce the level. For this operation you need to reduce the ground by a set amount rather to a set level. Naturally the 'Reduce' element is perfect for this as it allows you to specify an area and how much you want to reduce the depth.



Defining a section of road, milled to a depth of 200mm with a Reduce Element.

## Calculating the Volume of Demolished Materials

Another scenario in which Kubla Cubed can be used, is if a demolition has taken place and you need to calculate the volume of demolished materials that remains on site. Usually different materials will be collected into different piles called stock piles. A survey can be done of the elevations of these piles and Kubla Cubed can be used to estimate the volume of each stockpile. There is a chapter dedicated to stockpile estimating later on: [Stockpile Volumes](#) on page 111



---

# Chapter 11

---

## Bulk Earthworks

---

### Topics:

- [Bulk Earthworks - Overview](#)
- [Adjusting to Subgrade / Formation Level](#)
- [Soft Landscape \(Ponds, Gardens, External Works, etc.\)](#)
- [Hard Landscape \(Building Pads, Drives, Car Parks, etc.\)](#)
- [Recreational Grounds \(Golf Course, Sports Pitch, etc.\)](#)
- [Roads and Paths](#)
- [Retaining Walls](#)

Bulk Earthworks is the operation that takes place after a strip or demolition phase of a project. It is the process of building up or excavating to get to the formation level or subgrade level specified on the construction plans. There are different approaches required for different scenarios. In this chapter we will discuss some common scenarios and a recommended approach. However, Kubla Cubed is a flexible 'do all' volumetric calculator. These suggestions can be discarded if through experimentation you find a better approach that works best for your work-flow.

## Bulk Earthworks - Overview

When defining bulk earthworks it is possible to utilise all the element types to create the proposed topography or it is possible to use just use one. The definition of bulk earthworks elevations usually requires quite a bit more thought and planning than for instance the existing, strip or demolition phases which can be quite straight forward.

In regard to the best approach it often depends on what data you have in your site plan. If you have a set of contour lines defining smooth terrain it would be best to use a Feature Surface and use contour lines. However if you have a series of terraced areas than a number of platforms might be appropriate. For warehouse foundation with a number of ramps you could use some platforms and slope elements or define the whole thing in a feature surface with break-lines.

## Adjusting to Subgrade / Formation Level

Most site plans do not have the sub grade level marked. Instead they mark the final finished level (FFL) and a separate plan of surface material thickness. When estimating bulk earthworks we need to calculate to the subgrade so we need to find a way of adjusting for the subgrade in our project.

**Notes on Terminology :** In some areas of the world the term '*subgrade*' is used and others '*formation level*'. There are also a number of different terms used to refer to the level you will be standing on when the project has finished : '*finished floor level*', '*finished grade*' and '*final floor level*' are all used.

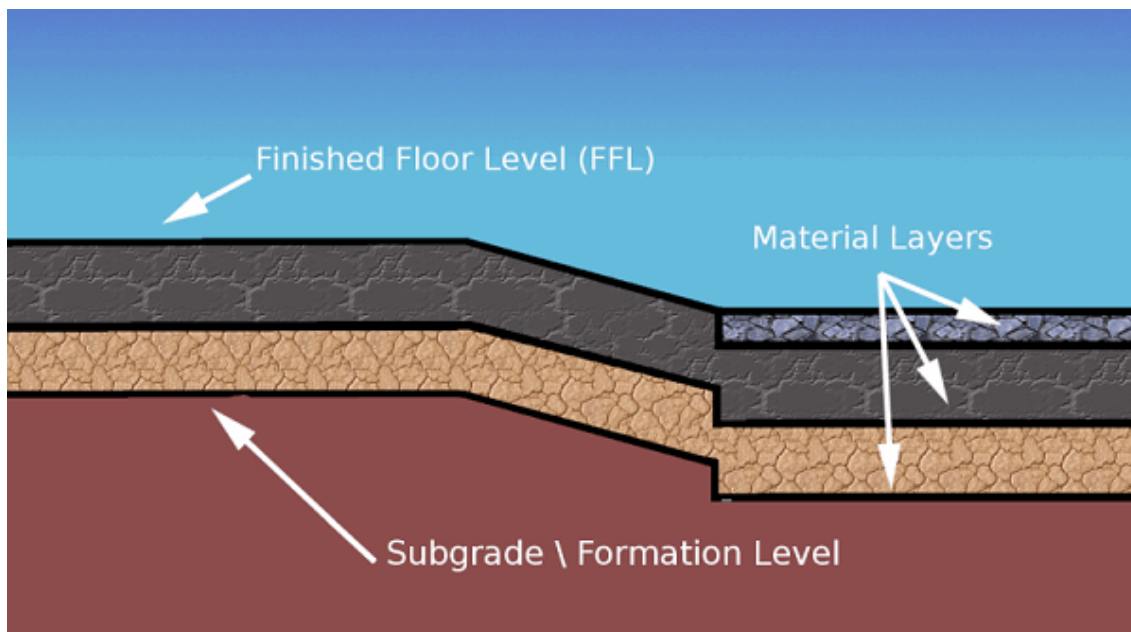

There is one issue that needs to be considered before starting and that is how to approach the problem of elevations being marked at FFL level on a site plan (this is almost always the case). In the bulk earthworks phase you will want to calculate to the formation/subgrade level not the FFL level so we need some way of making these adjustments. In general there are three approaches :

### The calculator method (not recommended)

This method involves manually adjusting elevations using a calculator before input. This works of course however it is flawed. Imagine adjusting 30 contour lines by 600mm only to be told later that after consideration the engineer has decided to use a different build up and changes it to 700mm. Going back and adjusting with a calculator again is very time consuming. The other issue with this method is that the elevations you look at on the plan don't match those you input which makes it hard to check. We therefore recommend two alternative methods.

### The Offset Method



The first method is called the offset method because we use the Z offset value that is available in all explicit level elements to offset an element with a negative value to make the required adjustment to the finished level. The Z offset input box is not available by default and has to be turned on by changing the define drop down in an element's properties for an option that includes an offset.

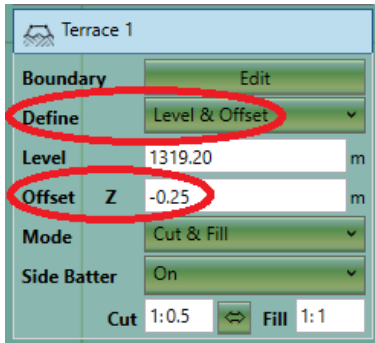

This offset method works very well when the different areas of material thickness are represented by different elements in a project. For instance if you have four building pads represented by four platforms and a car park represented by a feature surface it is easy to offset each platform and the feature surface to adjust for different material thickness values. However if the car park had different material thickness values across its surface we would run into a problem as there is only one Z offset box for the entire feature surface. We could split it up into different chunks but this can be awkward. Therefore in this scenario the strip method can be used to work around the problem.

### The Reduce Method

The offset method for adjusting FFL levels works well in most circumstances, however there are scenarios where you run into difficulties. On some site plans it can be difficult to break the proposed into different material areas. Typically this is the case when the proposed is defined by a single set of elevation features (contours lines or a point cloud). Breaking the proposed into different elements to cover different material thickness in this scenario can be awkward and lead to undesirable results at the boundaries of the different elements. As the contour lines or point cloud were not intended to be broken up you can end up with large step downs or jagged edges in the terrain. You can often fix this by adding more elevation features along the boundary but another approach is to use the reduce method as opposed to the offset method.

The reduce method involves putting all the proposed elevations at FFL into a single Feature Surface. You can actually use a number of absolute elements (Platform, Slope etc..) but in a simple setup a single Feature Surface is used. Once you have finished defining the FFL levels in your absolute element you then layer reduce elements over the top of the feature surface to adjust different areas by different material thicknesses.

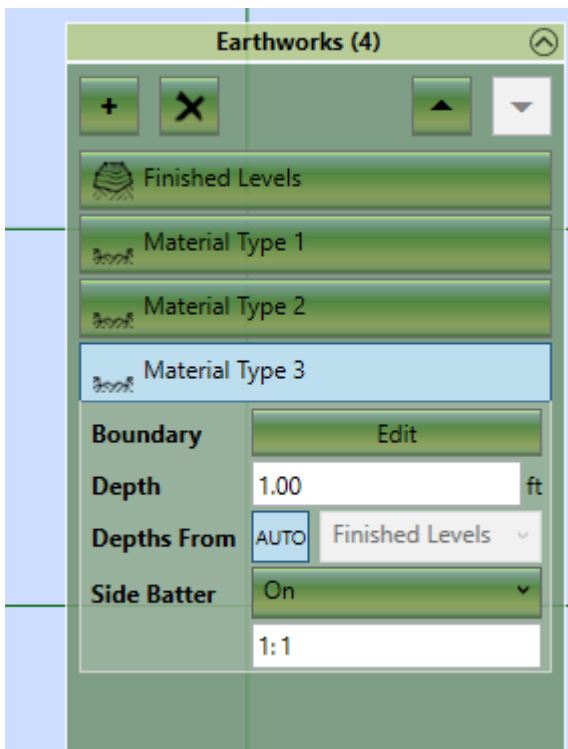

Reduce elements that intersect will override each other if set to 'Auto'. The lower reduce element will take precedence in the area of intersection. It is not recommended to change the setting from 'Auto' when using the 'Reduce Method' to adjust FFL levels as it is set perfectly to adjust lower FFL elements.

If following the 'Reduce Method' there are certain key rules you need to follow:

1. Reduce elements must be in the same phase as the elements that define the finished level.
2. The reduce elements must be below the finished level elements in the calculation order.
3. Usually the reduce elements have a very shallow side batter (e.g. 0.1 or 'Off').
4. The reduce elements should have 'Depths From' set to 'Auto'.

The 'Reduce Method' is in some ways simpler than the offset method however surfaces created using the 'Offset Method' can utilise the powerful side batter creation functionality in Kubla Cubed to create nice joins between different areas. With the 'Reduce Method' you have to create these side batters yourself with break-lines, contours and points. You can partially overcome this by using a number of absolute elements to define the FFL levels for areas that can be separated (e.g. building pads, parking lots etc...).



[Adjusting to Subgrade / Formation Level](#) looks at adjusting the FFL levels to the subgrade level using two different techniques: the offset method and the reduce method.

## Soft Landscape (Ponds, Gardens, External Works, etc.)

Soft landscaping areas are usually defined in a site plan with either points or contour lines. Sometimes break-lines are used if there is a hard edge to the surface, for instance if there is a slight ridge or gardens have a distinct terraced design.

The Feature surface is usually the correct element to use for this as you can define proposed with points, contours and break-lines with it. Even though soft landscape areas often do not need adjusting to a subgrade\formation level it is

a good idea to separate different soft landscape works into different elements. For instance, you might have one for gardens and another for ponds. This has advantages when it comes to reporting.

Ponds will most frequently be designed with concentric contour lines. However, it is possible to use a platform element or a number of different platform elements overlaid atop one another to design a pond.

Sometimes as well you may have a soft landscape area that needs just adjusting by a specified depth or height. For instance, if you wanted to just spread topsoil over an area you might want to just raise it by a certain height. To do this kind of operation you would use the reduce or raise elements.

In a bulk earthworks phase the software landscape areas are usually defined first and are at the top of the calculation order. This is so hard landscape areas such as building pads, car parks, roads and paths override them. For instance a typical calculation order for a housing estate would be

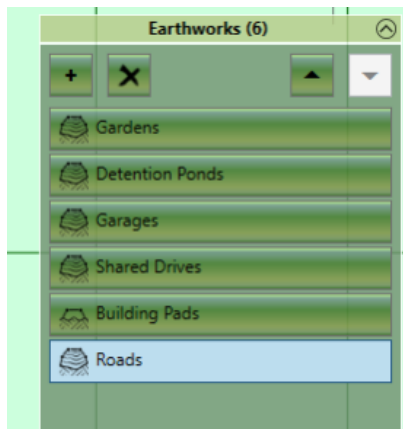

**Note:** The soft landscaped areas *Gardens* and *Detention Ponds* are higher in the calculation order; when they intersect with the hard landscape areas defined in lower elements, they are overridden.

## Hard Landscape (Building Pads, Drives, Car Parks, etc.)

If you are following the approach of defining the entire site in a Feature surface and then adjusting to a subgrade/formation level using the Reduce element, then hard landscaping can be modelled with contour lines and break-lines. Points are not a good way of defining hard landscaping areas as they are not necessarily joined in the way you would expect for hard edges (e.g. the edge of a building pad or car park). Firstly, closed contour lines can be used to define building pads and other flat areas. Break-lines can be drawn around the perimeter of car parks etc... to add that detail.

However, when modelling hard landscaping, the 'offset method' by which different areas of construction thickness are defined in different feature surfaces, does tend to create accurate surfaces far easier than the 'reduce method'. With the reduce method often a lot of time has to be spent with break-lines, contours and points to get the same effect of a few elevation elements combined. This is because Kubla Cubed generates side slopes for all elements, however when defining the whole site in one feature, all the side slopes of buildings, car parks, ramps etc. have to be defined with contours etc...

As with all take-off work, there is no one correct way to define things, however the following recommendations provide a good starting point when using the 'offset method' in regard to which elements to use:

**Building Pads, Drives, Garages:** For this the platform element can be used. You can define different areas in the same platform element with different outlines. However all areas in a single platform will have the same elevation. If you have many pads with different elevations (such as you would find in a housing project), a feature surface will allow you to define different pads with the 'fixed level' outlines. A different fixed level outline for each pad.

**Car Parks:** If the car park is a consistent slope or two consistent slopes perhaps then the slope element can be used for this. Frequently though, a car park is defined on a plan with elevations along the perimeter, in this case it is often easiest to use a Feature Surface and the 'varying level' outline. If there are extra elevations inside the car park, break-lines or points can be used, to add that detail.

**Ramps:** The slope element is useful for creating ramps. If the ramps are all on the same plane then you can use multiple outlines to define them in the same slope element. However if they are not then multiple slope elements can be used.

When using the offset method and splitting areas into different feature surfaces some consideration needs to be made in regard to the order of the elements. The elements lower in the calculation order will override the ones above. It is a good idea to put the more expansive areas at the top and the more detailed areas lower down. You don't need to carefully snap the boundaries between different areas together if you use the overriding behaviour strategically.

## Recreational Grounds (Golf Course, Sports Pitch, etc.)

---

Sports pitches often are very simple geometrically. For instance, a football pitch or tennis court could be simply defined with a platform. However, these types of pitches although appearing to be flat often are on a slight slope for drainage reasons. Therefore the slope element might be more appropriate.

A baseball pitch requires a bit more consideration. In this case there is usually a falloff in elevation from the pitcher's mound. This can be achieved by creating a feature surface and using concentric contour lines to define the desired topography.

Golf Courses tend to be smooth undulating terrain. However, there are hard edges that exist at the perimeter of bunkers and ponds. On a plan a golf course design is likely to be specified with contours, points and break-lines. The break-lines would be used for the defined edges like the bunker or water feature perimeter. Naturally for these scenarios you would use a Feature Surface in the proposed phase to design a golf course. It is also possible to prototype different golf course designs by combining different elements together. For instance, using platforms to sketch out ideas can be far quicker and simpler than designing with contour lines. When happy with the design and volumes estimated an export to CAD contour lines could be useful for additional refinement and to create a smoother surface than that which was created with overlaid platforms.

## Roads and Paths

---

There are several ways to define roads and paths in Kubla Cubed. Starting with a simple footpath the obvious choice is to use the 'Path' element. This allows you to place points along the centre line of a path and set absolute elevations. If you leave a point's Z entry blank it will interpolate from its neighbours. After you have created the centre lines you can set a width of the path. Another choice for doing a simple path is to create a berm, this will follow the topography of the centre-line at the relative heights specified.

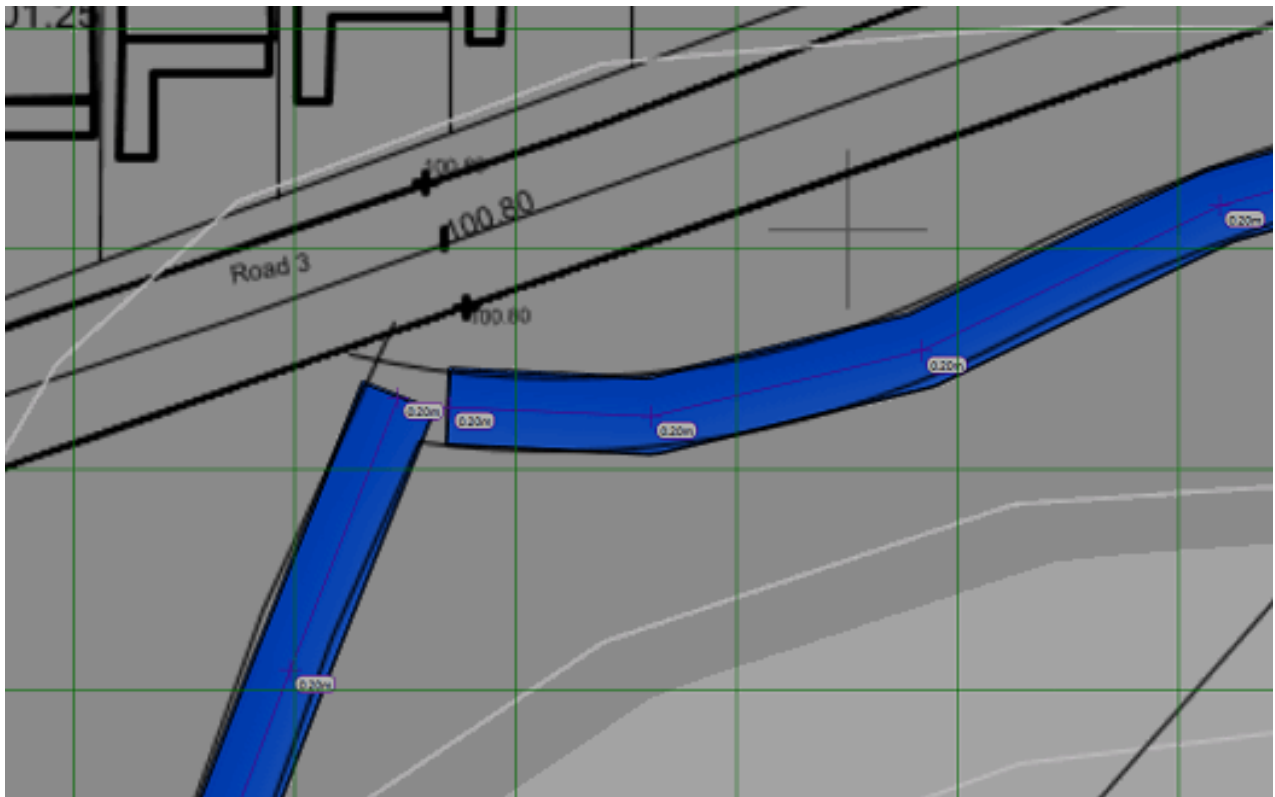

If you are defining roads you can of course use the path and berm element in the same way. However it is usually better to use the 'Feature Surface' for roads that take traffic, with the feature surface you defined the perimeter of the road with a feature surface outline. You can also use an outline within an outline to define a road that completely encloses a space.

There are a few different approaches to take in regard to defining the feature surface depending on the data that is marked on the site plan:

- **Extrapolate Outlines and Contour Lines (Not Recommended)** : This works OK but hundreds if not thousands of contour lines are often required to represent a road surface smoothly. The other methods are more efficient. This method is only really used if the contours are defined already in CAD or are the only thing marked on the site plan.
- **Extrapolate Outline and Break Lines (Quick)** : Another approach for defining roads with a feature surface which is quite quick is to define the centre line with a break line and then the road perimeter with an extrapolate outline. This will create a road surface that is flat which isn't optimal as most roads have a camber.
- **Varying Levels Outlines and Break Lines (Recommended)** : The recommended approach for defining a road surface is to define a centre line with a break line and then use a varying level outline to input the levels of the road perimeter. This allows you to define the camber of the road which is often desirable to get the most accurate surface. Sometimes there is no centre line marked on a site plan in which case just using a varying level outline without the centre line is the best option.

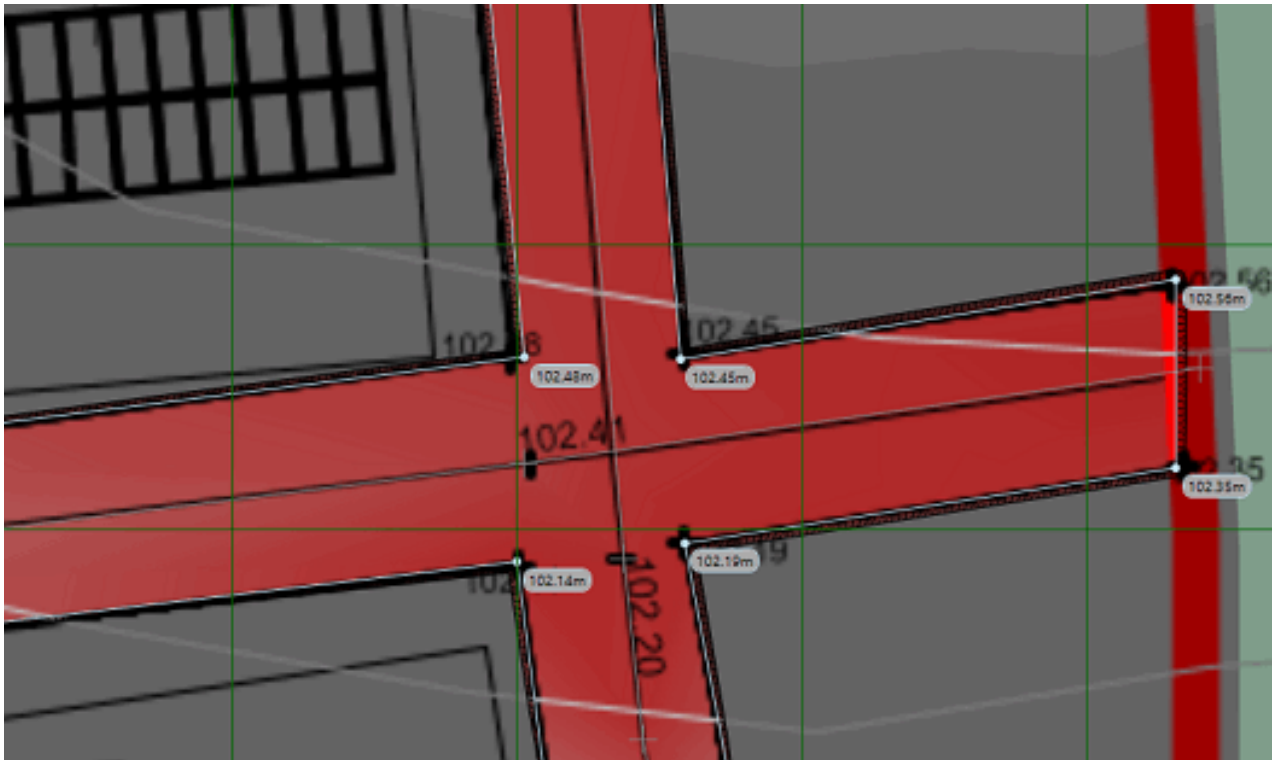

We have discussed the road surface but often you will also want to complete footpaths down the sides of roads for pedestrian or bicycle traffic. This can be achieved by creating separate feature surfaces below the main road surface in the calculation order for the pavements. If using the 'offset method' of subgrade adjustment you can then offset the road surface and footpaths separately. In order to avoid having to snap the side of the pavements to the sides of the roads exactly it is best to define the footpaths in the same phase as the road surface. If the footpaths are lower in the calculation order then you can tuck the roads underneath the footpaths. In the areas of intersection the footpaths will override the road elevations and it will create a smooth join between the two.



[Roads and Paths](#) A demonstration of the three methods that can be used to define roads and paths, using Kubla Cubed.

## Retaining Walls

There are broadly two different approaches to defining retaining walls; The first is using break-lines within a feature surface the second involves combining different elements together like the platform and path together. If adjusting to subgrade using the 'reduce method' (i.e a feature surface with a number of reduce elements) then you would use break-lines within the feature surface. If however, you were using the 'offset method' you could still use break-lines within a feature surface, but there is also an option of building up the retaining wall with various elevation elements.

### Break-Lines

With the break-line method you would first input the elevations on both sides of the wall. These would likely be points but could also be with contours that stop just shy of the wall. You then would input two break-lines. One at the top of the wall and one at the bottom. The gap between the break-lines would indicate the width of the wall slope when viewed on a plan. For instance, a near vertical wall would have break-lines very close whereas as are gentle slope would be much wider.

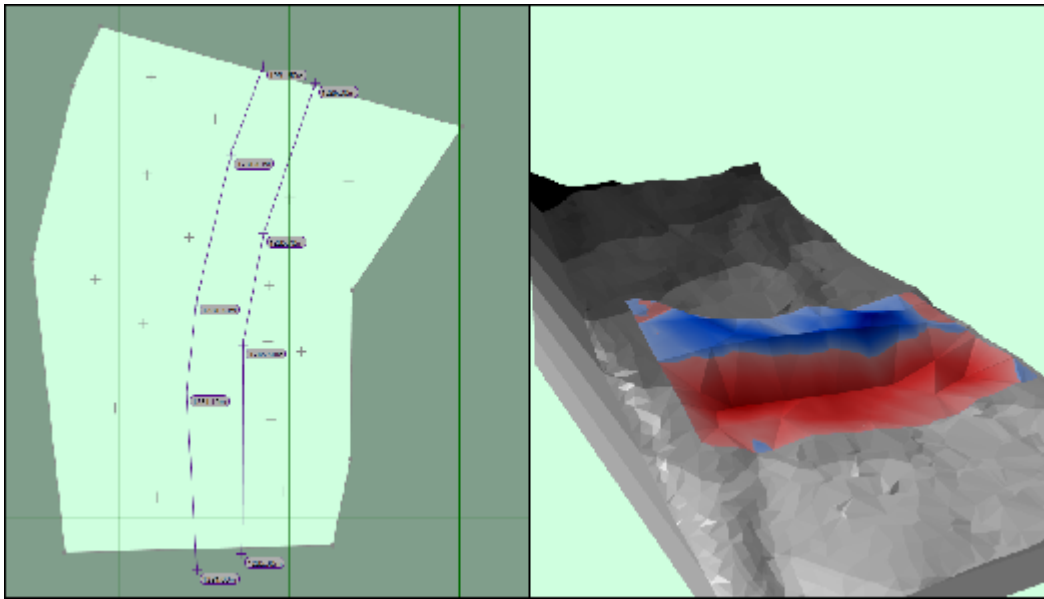

### Combining Elements

Another approach with retaining walls is to define them by combining different elements. For instance, the wall itself can be represented by a path (using absolute elevations) or a berm (using relative elevations). The backfill can then be defined with a platform element if the area is flat or a slope or feature surface if not. With the backfill element it might be advantageous to set the mode to 'fill only' so the element only fills to the ground and wall level rather than cuts from it.

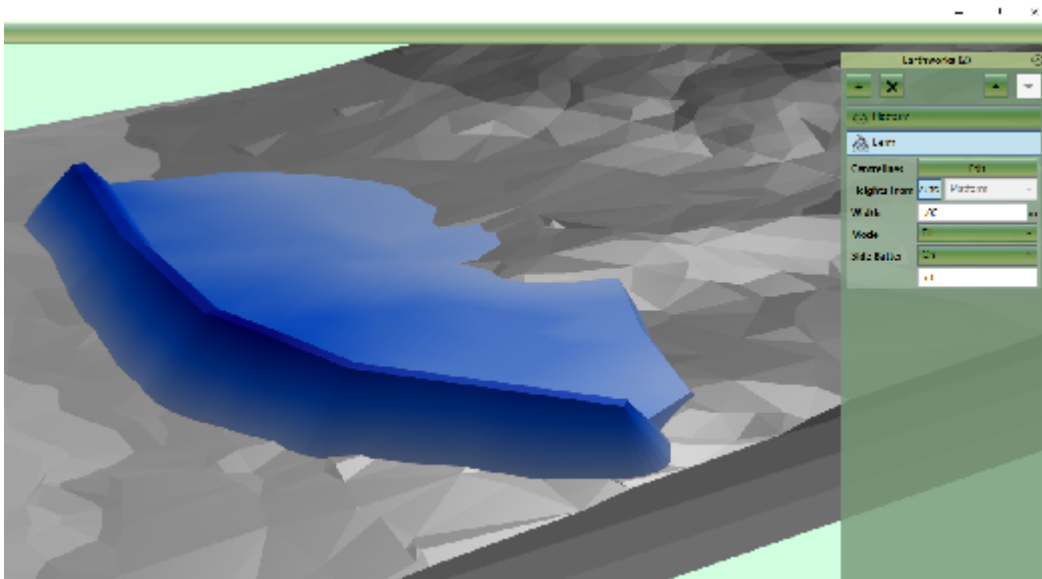





---

# Chapter 12

---

## Utility Trenches

---

Using the Trench tool, set the depth by using a positive value. Backfilling, which could be achieved with a Berm set to fill only, would need to be added on a subsequent phase.

**Note:** Where two trenches cross, the value from the trench with the greatest depth (at the point of intersect) will be used.



---

# Chapter 13

---

## Foundations

---

### Topics:

- [Modelling Foundations](#)
- [Backfilling](#)
- [Filling Around Structural Elements](#)

*Kubla Cubed* is a general earthworks estimation software, so it can be used to calculate foundation volumes even though they are usually fairly straightforward to measure by simple hand calculations. However there are advantages to modelling foundations in *Kubla Cubed*, particularly where backfilling around the foundations is required. Also it is useful for creating step by step 3D images of the work taking place.

## Modelling Foundations

The volume of foundations can be modelled in *Kubla Cubed* in just the same way as any other earthworks element. The only real differences are that the slope batter for foundations are almost always set to vertical, and that foundations often have holes inside them. The ability to cut holes out of volumes is a standard feature in *Kubla Cubed*, but is much less commonly-used for actual earthworks elements. Cutting holes is easily achieved by adding internal outlines within the external ones. The internal outlines will be automatically detected and removed as holes.

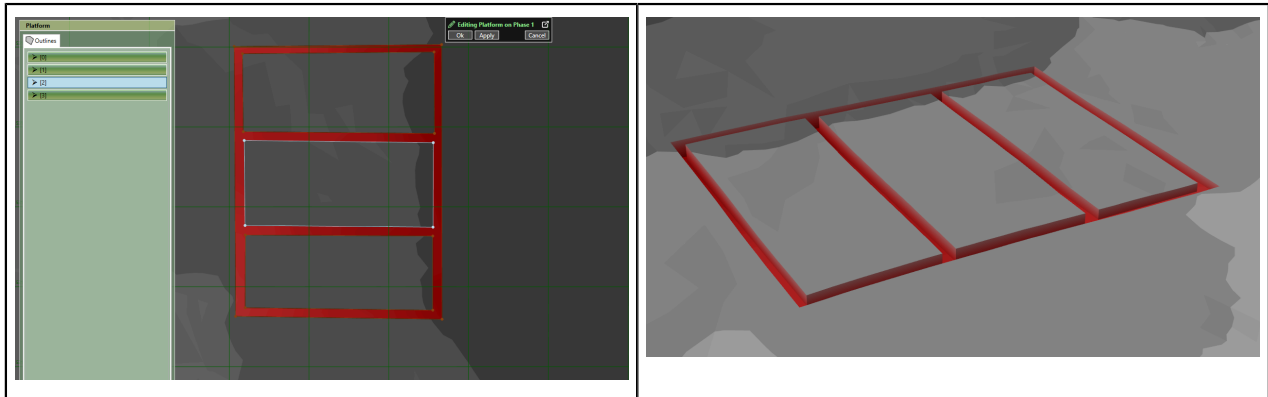

*The ability to remove internal areas is an occasionally-used feature for normal earthworks elements, but is routinely required when modelling foundations*

## Backfilling

Backfilling is the process of filling up a cavity with material after an excavation. *Kubla Cubed* can be used to calculate the material that will be used in a backfilling operation. It is critical that an additional phase to complete a backfill operation, excavation and backfill cannot be completed in a single phase. A number of elements can be used to define the surface of the backfill material, however there is a trick that can be used to save time in tracing around the perimeter of a cavity. If we set an element like the platform to 'fill only' mode it cannot cut from the surface. Using this technique we can trace a platform over the general area of backfill and it will fill up the cavities to the given level, as long as the elevations around the cavities is more than the backfill level than they will remain untouched.

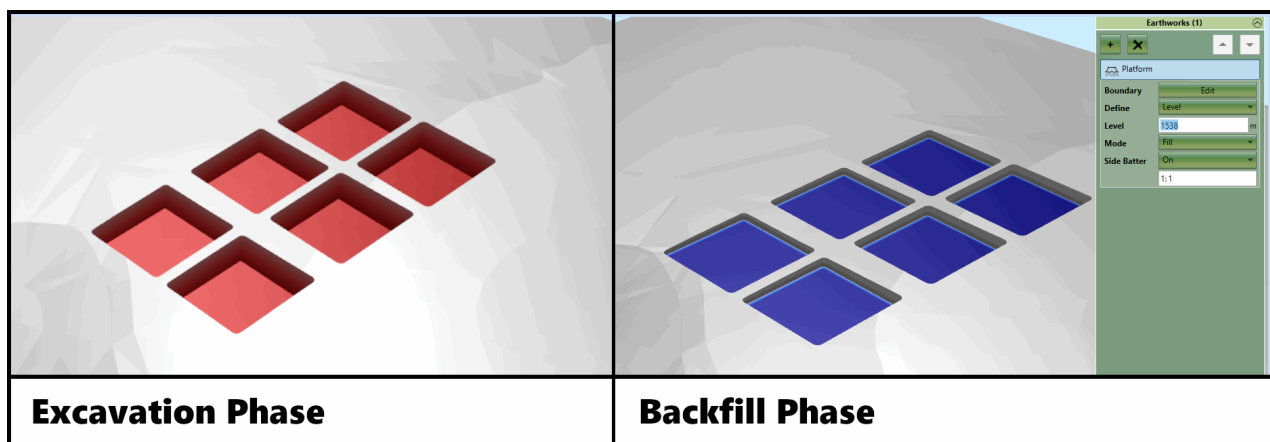

*Excavation in one phase has been backfilled in a subsequent phase by using a platform over the area and setting the platform to 'Fill Only' mode.*

The backfill trick does not need the backfill to be at a set fixed level to work, you can use the same technique with any other absolute element (e.g. Slope or Feature Surface).

## Filling Around Structural Elements

---

Another trick that can be employed when estimating building foundation volumes is to create phase that contains structural elements which will be ignored from the cut and fill calculations. The fill for these elements will be calculated but it is often irrelevant as the elements could be precast concrete or a temporary concrete framework. In a way they could be described as dummy earthworks elements used to create a solid surface where structural elements will be. In a subsequent phase elements can be set to 'fill only' and fill around those structural elements. This can make the job of filling around complex space a lot easier and the visualisations make a lot more sense. An alternative approach is to define the boundary outlines of the proposed carefully to leave the structural areas untouched. However the models created by using 'dummy earthworks' for structural elements tend to be easier to understand.

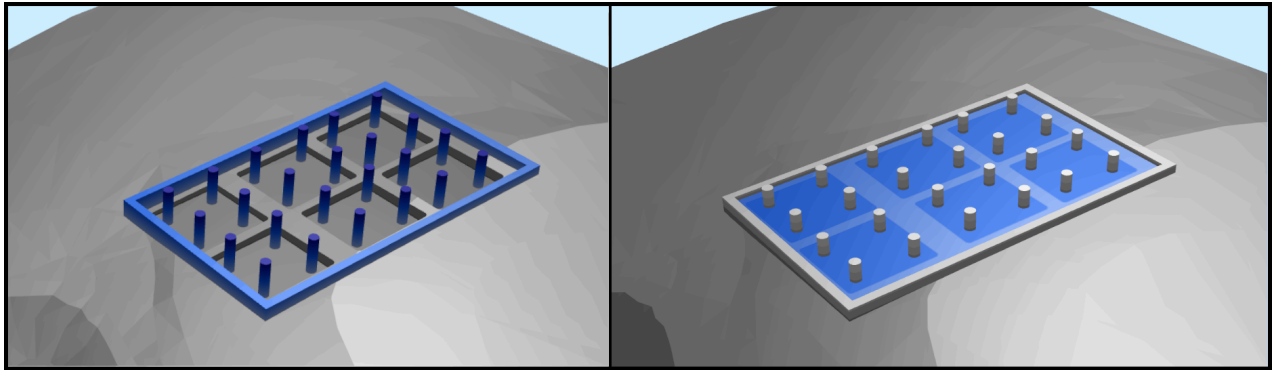

*Dummy earthworks used to represent precast concrete pillars and wooden frame before estimating concrete fill volumes in a subsequent phase.*



---

# Chapter

# 14

---

## Paving, Turf and Sod

---

### Topics:

- [Using Reported Areas to Calculate Paving Volumes](#)
- [Using the Raise Element to Report Paving Volumes](#)
- [Obtaining a Breakdown of different Paving Strata](#)

Paving is a layer of hard material that forms the surface of a built environment (e.g. a road, pavement, drive). In this chapter we use the term more broadly to discuss the layers that are completed in the final phases of a project to build up to finished level be it turf (aka sod), asphalt, tiles, woodchip or anything else. The bulk earthworks as discussed in earlier chapters will result in topography defined to the Formation/Subgrade Level with cavities where paving will be. Estimating of paving often is done by taking area measurements of the paving and then finding the volume using a simple calculation of Area x Paving Thickness. Although this is often sufficient, it is also possible to model paving build up in Kubla Cubed, by modelling the paving elevations and calculating the volumes.

## Using Reported Areas to Calculate Paving Volumes

---

It is common for estimators to use Kubla Cubed to measure volumes and then use another 2D take-off program to measure areas. They can then calculate the paving volumes by multiplying the area by the thickness. This a simple approach, however it does involve potentially measuring the same areas twice. Once in Kubla Cubed and once in the other program. This is time consuming if site plans need to be imported twice and scaled and stitched twice.

It is possible to use Kubla Cubed areas to calculate using this technique. The first method is simply to use the 'Area' element which can be found in the 'Measurement' panel. Here you can take-off area measurements and then use the 2D Boundary Area in the 'User Input' reports to make paving estimates. This works but does not use 3D areas and potentially requires you to retrace areas you have already traced when doing the bulk earthworks. However it does avoid having to import site plans into another program

### Choosing between 2D or 3D Areas

Before using areas to calculate paving volumes it is worth considering whether you want to use 2D or 3D areas. The 2D areas reported are the same as if measured from a paper plan, this is often the traditional approach to estimating paving volumes. The 3D areas take into account the surface area of the topography and therefore will always be the same or larger than the 2D area. Mainly when calculating paving 2D areas are sufficient, however 3D areas might be required if the land is on a steep incline where the surface area in 3D is far greater than it is when viewed from above. If you think of a golf course and the calculations required for how much turf might be needed a 2D area would often leave you considerably shy of the true requirement.

Another method to obtain the areas is to use the earthworks estimation disturbance areas. The 2D areas or 3D areas can be used depending on requirements. If you have setup your bulk earthworks in such a ways that either :

A) Using the 'offset method' you have different paving areas represented by different elements

or

B) Using the 'reduce method' method you have different paving areas being reduced by different reduce elements

Then the 'Break down by Element' in the earthworks estimation report can be used to find the areas of the paving. Both the 2D areas and the 3D areas are available depending on requirements.



Create Earthworks Estimation Spreadsheet

	K	L	M	N	O	P	Q
1							
2							
3							
4							
5							
6							
7	Fill 3D Area (m <sup>2</sup> )	Fill Volume (m <sup>3</sup> )	Net Differences (m)	Net Levels (m)	Net 2D Area (m <sup>2</sup> )	Net 3D Area (m <sup>2</sup> )	Net Volume (m <sup>3</sup> )
8	27.92	715.92	2.07 cut to 4.8 fill	1276.2 to 1291.99	869.05	1219.23	541.08
9	231.21	2836.58	2.77 cut to 4.8 fill	1276.7 to 1291.98	6303.96	6519.9	62.11
10	50.29	824.11	2.45 cut to 3.28 fill	1278.22 to 1283.45	1832.93	1895.63	-55.72
11							
12	Fill 3D Area (m <sup>2</sup> )	Fill Volume (m <sup>3</sup> )	Net Differences (m)	Net Levels (m)	Net 2D Area (m <sup>2</sup> )	Net 3D Area (m <sup>2</sup> )	Net Volume (m <sup>3</sup> )
13	309.41	4376.62	2.77 cut to 4.8 fill	1276.2 to 1291.99	9005.94	9634.76	547.47
14							
15							
16							
17							
18							
19							
20							
21							
22							
23							
24							
25							

Topsoil Stripping Bulk Earthworks

OK

There is one catch with this method and that is if an element does not actually change the ground in one area. For instance if an earthworks element only ends up changing 70% of the ground (i.e some of the proposed levels match the ground level) then the disturbance areas will not report the whole area and hence cannot be used for paving calculations. Another issue can be that disturbance areas will also include the side batter of an element, this not be what's required so in this case another method would have to be used.

#### Why not use Boundary 2D Areas contained in the User Input Reports?

It is possible to use Boundary 2D Areas reported in the User Input reports for this task, but there are a couple of issues. Firstly they report the area of the boundary outline which does not include the side slopes of the earthworks (although this might be desirable). A potentially bigger problem relates to intersecting earthworks elements. If two earthwork elements intersect, the one lower in the calculation order will report in the area of intersection, this means you will not get double reporting of disturbance areas (2D or 3D) or volumes. However the User Input areas do not have this benefit so the areas will double report paving if two earthwork elements intersect.

## Using the Raise Element to Report Paving Volumes

Rather than taking areas and then multiplying then by paving thickness to get the volume of paving it can be a good idea to model the paving using earthworks elements. Even though this method can be a bit slower than using areas

that are already reported in previous phases, it does have the advantage of resulting in the last phase of your project built up to finished level. This can be very useful for checking your site as you can do spot checks or cross sections to check the elevations reported from the model against the site plan match (site plans almost always show FFL levels). To complete paving calculations using Kubla Cubed's modelling tools is a bit similar to completing a topsoil strip but in reverse :

You must define paving in it's own phase, so create a new phase called 'paving' or similar. Raise elements can then be used with a height set to the pavings overall thickness. If Raise elements overlap, they will override each other. Where they intersect the depth in the lower element in the calculation order will take precedence. This works as a reduce element has the 'Heights From' property set to 'Ground' by default if there are no absolute elements above in the calculation order. It is not recommended to change these options from default or use absolute elements in a paving phase so the behaviour of raise elements overriding each other is consistent.

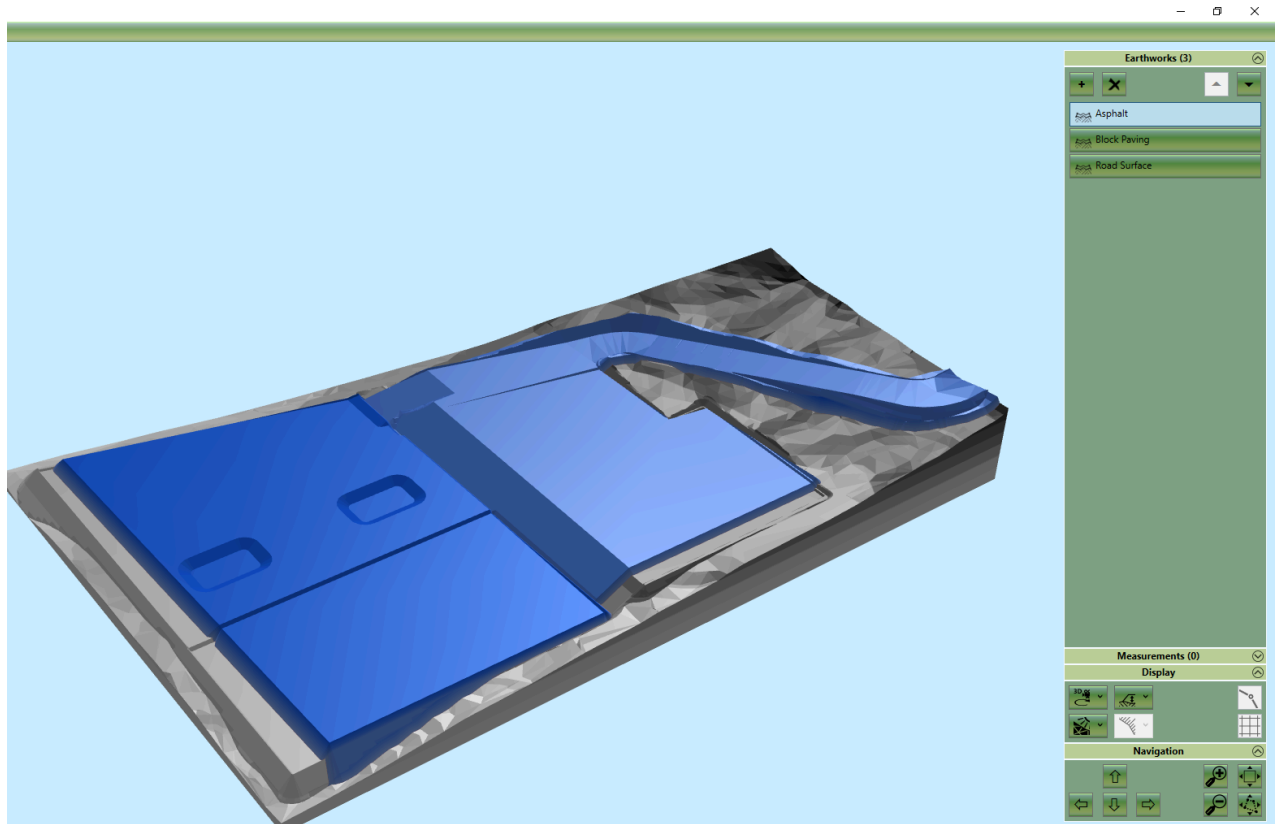

*Paving volumes calculated using 'Raise' elements, where the paving elements intersect the height in the lower element in the calculation order takes precedence (using default settings).*

## Obtaining a Breakdown of different Paving Strata

Rarely is paving made up of a single material. For instance a tiled area will maybe have layers of sand and gravel underneath for stability. A road would have many more layers. If you have an overall paving volume calculated it is quite easy to break this down into different layers using ratios or percentages. For instance if paving is made up of 20% tile, 20% sand and 60% gravel it is not too break down an overall paving volume into different materials in a spreadsheet. However you can model this also in Kubla Cubed. To do so you need to create a different phases for each layer and use reduce elements with a height set just to the thickness of the strata. This will have the benefit of each material in paving having a separate volume in the reports and spreadsheets. Using this method it is best to have one phase per material and name the phase after the material. For many projects this would be considered overkill considering how easy it is to complete in a spreadsheet, however it is possible to do this if needed.

---

# Chapter 15

---

## Marine Dredging & Reclamation

---

### Topics:

- [Coordinates and Bathymetry](#)
- [Modelling tools](#)
- [Visualisation](#)

*Kubla Cubed* is routinely used to calculate dredging and reclamation quantities for coastal engineering projects. *Kubla Cubed* is not only competent to do this, but makes it extremely quick and easy to investigate dredging and reclamation options at the concept design stage.

It should be noted that *Kubla Cubed* is not specialist coastal engineering software and Kubla does make a more specialist software called *Kubla Ports*. If you are heavily-involved with coastal engineering you may wish to investigate this software as well.

In this chapter, we'll discuss the coordinate system used in *Kubla Cubed* and the potential requirement to convert data prior to edit. There is coverage of bathymetry (measurement of depths below landform) before a focus on how different *Cubed* elements and settings can effectively contribute to a coastal project.

## Coordinates and Bathymetry

---

### Coordinates

*Kubla Cubed* uses a Cartesian co-ordinate system, either in metres (mE, mN) or feet (ftE, ftN). The co-ordinate system is not defined in the software, and it's up to the user to ensure that all the data they are loading are in a consistent Cartesian co-ordinate system.

In coastal engineering it is common to have data in a spherical co-ordinate system (°E, °N). If you have such data, you will need to use other software to convert into a Cartesian co-ordinate system of your choice, such as UTM, before importing into *Kubla Cubed*. If you have raster images in spherical co-ordinates that you want to load as site plans, you should ideally use software to skew them into your chosen Cartesian co-ordinate system before loading them as site plans.

### Processing Bathymetry

Perhaps one of the biggest challenges with coastal engineering projects is the wide range of bathymetric data that may be available. Typical sources of bathymetric information range from PDF contour maps, to raw data from echo sounders in text files. *Kubla Cubed* can combine data from a range of sources, but like any ground modelling software, careful consideration needs to be given to how you define your bathymetry.

Since *Kubla Cubed* is based on Triangulated Irregular Networks (TINs), it's quite possible to combine a range of disparate sources of bathymetry data. E.g. one part of the site may have high resolution gridded data from a bathymetric survey, while another part may only have data from contour lines traced off a PDF.

Bathymetric data as received from echo-sounding is likely to need to be processed before it will be usable in *Kubla Cubed*. Processing is required both to remove outliers and erroneous soundings, and also to thin the data to prevent the software from slowing down to a point where it is unusable. Bathymetric processing is a specialist task and beyond the scope of *Kubla Cubed*, so it must be done in other software before importing. Typically the data might be gridded before being imported into *Kubla Cubed*. The grid resolution should be adequate to ensure accuracy, while not being so dense that the software becomes difficult to use.

## Modelling tools

---

While land-based earthworks projects typically have contoured design levels, coastal projects tend to be somewhat simpler in this respect, with a series of flat area to be dredged or reclaimed. For this reason, a number of the design elements available in *Kubla Cubed* are rarely be used on coastal projects. The following two elements are typically the most useful:

- **Platforms** are used to define flat areas by drawing the outline of the flat area. These are useful for dredging berth pockets and turning circles, for example.
- **Paths** are used to define areas by drawing a centreline and specifying the width. These are useful for dredging channels, for example.

### Cut Only and Fill Only

One of the key differences between typical coastal engineering projects and land-based earthworks is that only cut or only fill is often specified. E.g. for a dredging project you only remove material, and do not fill to the designed level. Since *Kubla* has been used for coastal engineering from the outset, this has always been an option on every earthworks element. Achieving this is simply a matter of setting the 'Mode' to 'Cut' instead of the default 'Cut & Fill'.

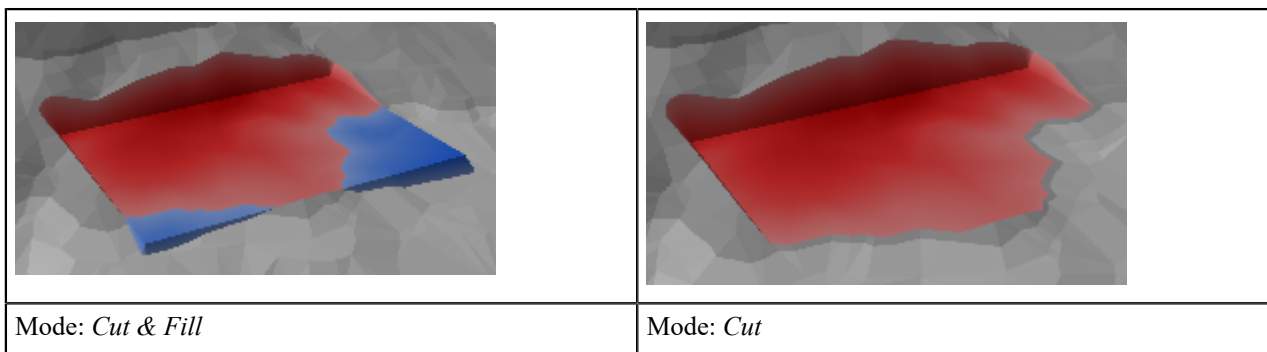

The cut-only mode, which is rarely used on land-based projects, is routinely required for coastal projects.

### Side Batters

One powerful feature of Kubla Cubed is the ability to automatically generate side batters, to slope between the design ground levels and the existing bathymetry. This is particularly important for coastal projects, where the batter angles can be quite low and the volumes within these batters can represent a significant part of the volumes.

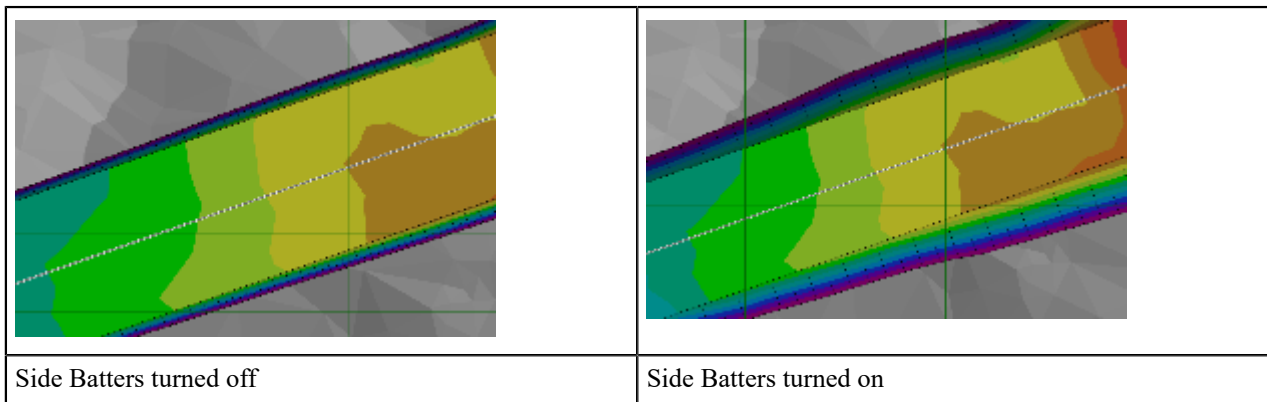

Side batters can comprise a significant part of the volumes on coastal projects. *Kubla Cubed* generates them automatically, and you can adjust the batter angles as required.

## Visualisation

Kubla Cubed offers a range of editable effects to aid visualisation.

### Vertical Exaggeration

Due to the scale of coastal engineering projects, the variation in Z values is usually trivial compared to the size of the project. As a result 3D visuals can appear to be almost flat. For this reason, *Kubla Cubed* allows you to exaggerate the vertical scale when you are viewing in 3D.

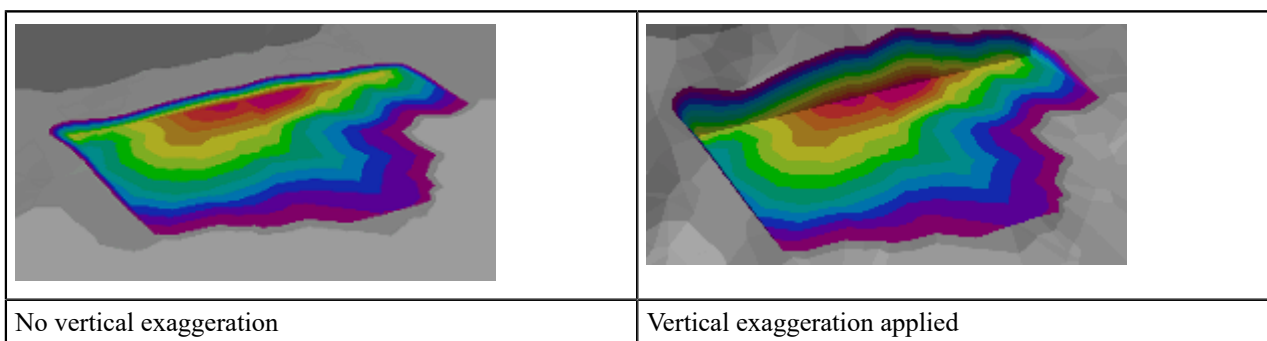

The vertical exaggeration can be increased to improve understanding of the variations in 3D topology when viewing very large projects.

### Shading Schemes

Since typical dredging projects are cut-only as described above, the default shading scheme, which displays cut in varying shades of red, and fill in varying shades of blue, is not particularly appropriate. Commonly dredging is displayed in a Rainbow shading scheme, which maximises the contrast in dredging depths. This is provided as a default shading scheme, but you can also customise as required.

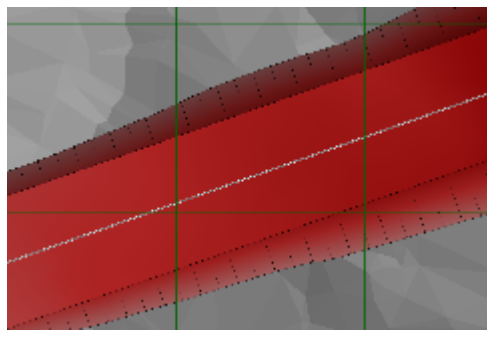
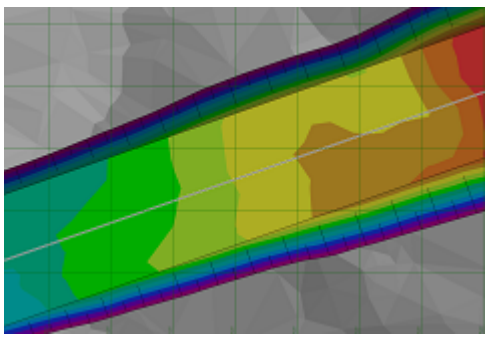
	
Default red (cut) and blue (fill) shading	Preset shading scheme 'Rainbow' applied

Typically the rainbow shading scheme is used to display dredging depths, rather than the default red and blue.

---

# Chapter 16

---

## Stockpile Volumes

---

### Topics:

- [Importing Survey Point File \(.CSV, .XYZ, .XLS, UAV\)](#)
- [Calculate the Volume of the Stockpile](#)

There are various ways to calculate the volume of stockpiles. In Kubla Cubed, we will look at calculating stockpiles using survey data.

This chapter will show how to import survey data from your stockpile and then show how to calculate the volume.

## Importing Survey Point File (.CSV, .XYZ, .XLS, UAV)

With the first phase (called 'existing') selected, add a new element of the type 'Feature Surface' from the earthworks panel in the top right. This element will act as container for the data to be imported. Your survey files will contain points stored in text based format, typically .csv, .xyz, xls or .uav (e.g. mydata.csv).

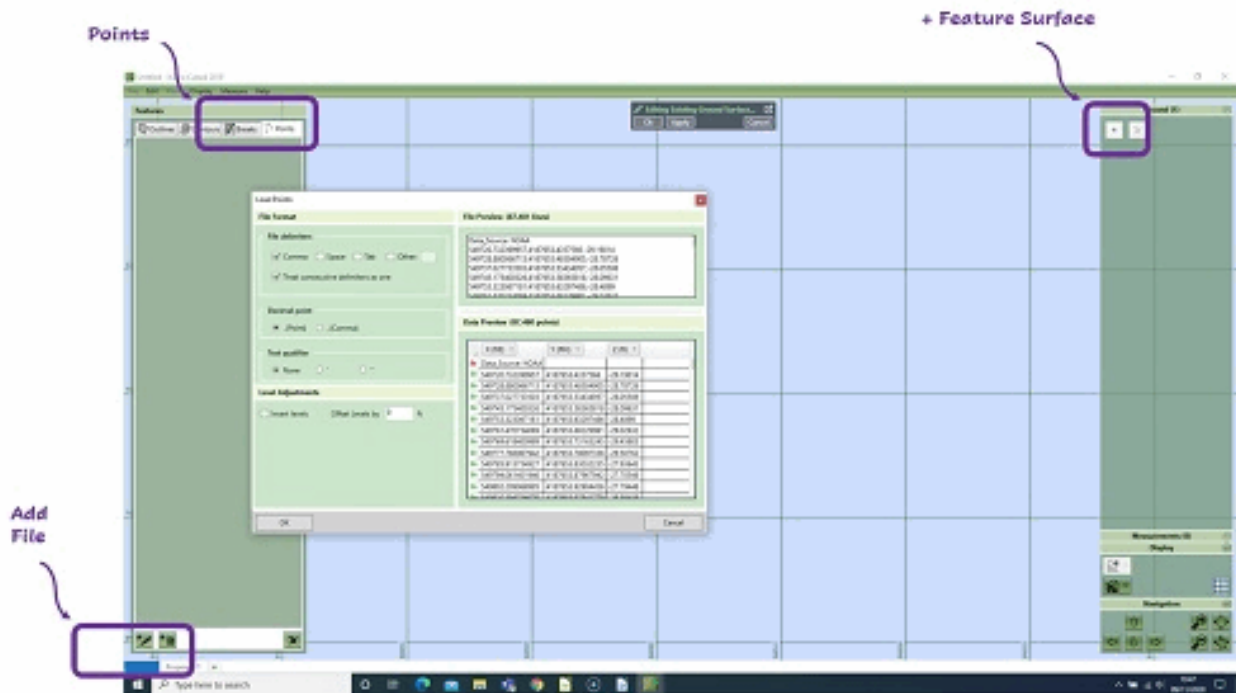

Your new Feature Surface will be opened, the stats panel in the top left will disappear and in its place will be a panel with four headings (Outlines, Contours, Breaks and Points). As you will be editing points, the fourth tab (Points) must be selected. Now, in the bottom left, choose the second button in, to 'Add Points from Site Plan or File'. If you hover the mouse above the button, a tool-tip will appear, so you can verify you are selecting the correct option.

A new window will appear within which the file format settings can be changed. Check that the X,Y,Z columns in your file are appearing in the table correctly. When everything looks correct, click on the OK button to load the points into your project.

Finally, add the boundary outline of the stockpile. Select the first of the four tabs at the top of the panel, it is the one marked 'Outlines'. Now, click on one of the buttons at the bottom of the panel, to create or load an outline. If choosing to create an outline, there are two main options: 'Automatic' and 'Draw'. Automatic will essentially shrink-wrap the points loaded earlier. This process is software controlled, although a preview with fidelity slider is provided, before completion. Drawing of the outline manually is human controlled. Alternatively, if you have a PDF or CAD file with the outline defined, you can import it by Adding from File as mentioned previously.

Additionally, if your stockpile has been defined in a CAD or PDF format, then there is also the option to add points, contours and break lines from these, by selecting a sample entity of the points/lines you want to import. Go to the CAD import section for more details.

## Calculate the Volume of the Stockpile

With the existing surface now complete, you can move to the proposed tab to add a Platform to calculate the volume.

Using the 'Platform' element, draw a boundary around your stockpile base and adjust the level of the platform to the average elevation level at the base. Once your Platform is complete, in the Earthworks panel the listed 'Platform 1', change the 'Mode' to 'Cut'.



The images show (Cubed 2019) 2D and 3D visualisation of the stockpile cut, leaving a flat surface where it once was. In this scenario the stockpile survey becomes the ‘existing surface’ and a flat area is the ‘proposed’. We are asking the program to give us the ‘cut’ if we just excavate the stockpile to a given level with a given perimeter.

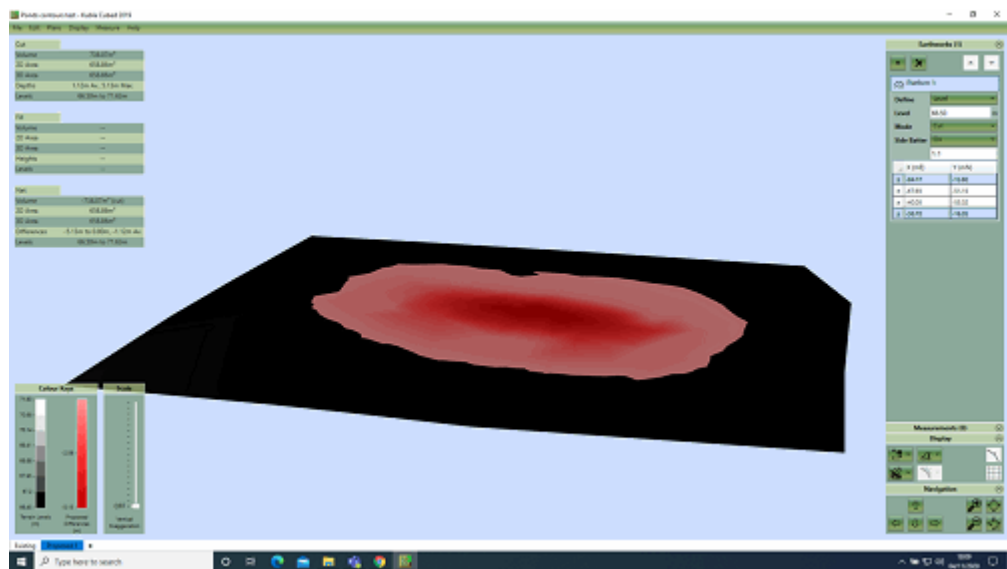
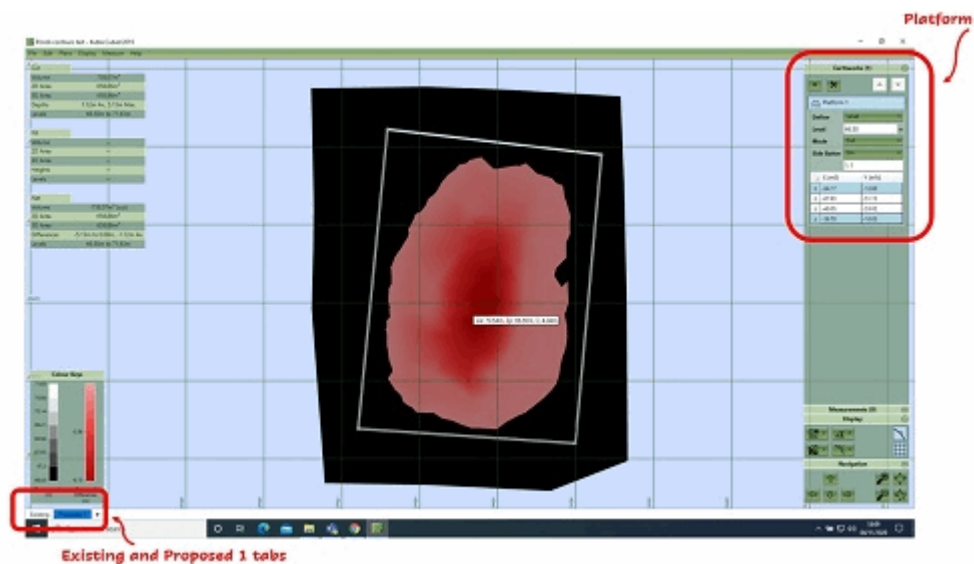

The stockpile elevations defined in the existing, will now show reduced to the Platform level, as a result you will find the cut volume (top left-hand corner) which represents the volume of the stockpile.



---

# Chapter 17

---

## Exporting Spreadsheets & Reports

---

### Topics:

- [Creating Reports](#)
- [Creating Spreadsheets](#)

When it comes to presenting the results of a project to a client, colleague or other stake-holder, *Kubla Cubed* has a number of options available:

- **Spreadsheets:** An earthworks estimation spreadsheet can be produced that breaks down the earthworks in each phase. There are subsequent breakdowns by region, and by element. Another spreadsheet containing input data can also be produced, which is useful for validating inputs and viewing measurement information. For more information see [Creating Spreadsheets](#).
- **Reports:** An earthworks estimation report can also be produced with the same breakdown as the spreadsheet. The report contains diagrams and formatting that makes it easier to understand so is often more appropriate to give to clients than the spreadsheet. A report containing input data can also be produced for validating inputs and viewing measurement information. For more information see [Creating Reports](#).
- **Reporting in the Software:** For all phases except the first, a statistics panel will display in the top left with cut and fill data. The level of detail can be controlled from the 'Project Settings', located in the 'Settings' menu. The statistics panel will not show when an element is being edited.

Within the program the options for presenting the above data are contained within the File menu. Here you will find the Create Spreadsheet and Create Report sub menus.

## Creating Reports

---

To export a report click on the File menu item, then Create Report and finally Input Data or Earthworks Estimation, depending on the report you wish to create. The report can be saved in the MS Word (.docx) or Adobe Acrobat (.pdf) format.

### Input Data Report

A report of the user input data, including all properties, boundary areas and perimeters. The report can be useful for validating input data and using boundary perimeter and area values in a bill of quantities (BOQ) or for doing further calculations on the data.

The report will contain the input data that has been entered by the user into the program. It contains no information regarding earthworks calculations (cut & fill); that information is contained in the earthworks estimation report. The count, area and length measurement elements will only appear in this report as they have no relevance to the earthworks estimate.

**Notes on Boundary 2D Area and 2D Perimeter :** The boundary areas and boundary perimeters in the input data report relate to the element boundary lines that have been input by the user. They will often differ considerably from the areas in the earthworks estimation report which are calculated from the earthworks area of disturbance.

Volume region elements are not allowed to overlap each other. Where one volume region is inside another, the area of the internal volume region will be removed from the external one. The area and perimeters presented for volume regions in the report are the areas after they have undergone this processing.

### Earthworks Estimation Report

A report of the earthworks estimation, including levels, volumes and depths can be exported to a .xlsx file. The report can be useful for building into an earthworks bill of quantities (BOQ) report or for doing further calculations on the data.

This report will contain the earthworks estimation output calculated by the program. This includes cut/fill volumes, depths and areas. The earthworks estimate is completed for all earthworks in the phase. In addition it can contain the following breakdowns.

- **Breakdown by Element:** The element breakdown will show you the cut & fill contribution of each element in a phase, based on the disturbance areas of each element. This can be very useful if different earthworks have been represented by different elements (e.g. roads, building pads, gardens etc...). If elements intersect then consider how to attribute the cut & fill in the intersecting areas. The approach used in Kubla Cubed is to report the cut & fill to the element that appears lowest in the calculation order. This correlates to the way that element elevations override each other in most scenarios, the lower element takes priority.

It is important to note that the element breakdown does not calculate cut & fill between elements. In Kubla Cubed within each phase, all earthworks elements are combined into a single surface and cut & fill is calculated between the resulting proposed surface and the ground surface. However, multiple phases can be used if you want to calculate cut and fill between multiple surfaces. The earthworks report is helpful for viewing the breakdown by element regions, as it has a diagram above each element breakdown table.

- **Breakdown by Region:** If volume region elements exist in a phase, a breakdown by region will be completed. A region within a region will be handled by first calculating the outer region excluding the inner region and then calculating the inner region separately.

**Notes on Earthworks Estimation 2D and 3D Areas :** 2D and 3D areas in the earthwork estimation report relate to the earthworks footprint (sometimes referred to as the area of disturbance). For the area and perimeter of the element boundaries refer to the input data report. The 2D areas reported are the same as if measured from a paper plan. The 3D areas take into account the surface area of the topography and therefore will always be the same or larger than the 2D areas.



[Exports - Report & Spreadsheets](#) video describes the main sections of a typical report.

## Creating Spreadsheets

To export a spreadsheet click on the File menu item, then Create Spreadsheet and finally Input Data or Earthworks Estimation, depending on the spreadsheet you wish to create. The spreadsheet can be saved in the MS Excel (.xlsx) format.

### Input Data Spreadsheet

A spreadsheet of the user input data, including all properties, boundary areas and perimeters. The spreadsheet can be useful for validating input data and using boundary perimeter and area values in a bill of quantities (BOQ) or for doing further calculations on the data.

The spreadsheet will contain the input data that has been entered by the user into the program. It contains no information regarding earthworks calculations (cut & fill); that information is contained in the earthworks estimation spreadsheet. The count, area and length measurement elements will only appear in this report as they have no relevance to the earthworks estimate.

**Notes on Boundary 2D Area and 2D Perimeter :** The boundary areas and boundary perimeters in the input data spreadsheet relate to the element boundary lines that have been input by the user. They will often differ considerably from the areas in the earthworks estimation report which are calculated from the earthworks area of disturbance.

Volume region elements are not allowed to overlap each other. Where one volume region is inside another, the area of the internal volume region will be removed from the external one. The area and perimeters presented for volume regions in the spreadsheet are the areas after they have undergone this processing.

### Earthworks Estimation Spreadsheet

A spreadsheet of the earthworks estimation, including levels, volumes and depths can be exported to a .xlsx file. The spreadsheet can be useful for building into an earthworks bill of quantities (BOQ) report or for doing further calculations on the data.

This spreadsheet will contain the earthworks estimation output calculated by the program. This includes cut\fill volumes, depths and areas. The earthworks estimate is completed for all earthworks in the phase, in addition it can contain the following breakdowns.

- **Breakdown by Element:** The element breakdown will show you the cut & fill contribution of each element in a phase, based on the disturbance areas of each element. This can be very useful if different earthworks have been represented by different elements (e.g. roads, building pads, gardens etc...). If elements intersect then consider how to attribute the cut & fill in the intersecting areas. The approach used in Kubla Cubed is to report the cut & fill to the element that appears lowest in the calculation order. This correlates to the way that element elevations override each other in most scenarios, the lower element takes priority.

It is important to note that the element breakdown does not calculate cut & fill between elements. In Kubla Cubed within each phase, all earthworks elements are combined into a single surface and cut & fill is calculated between the resulting proposed surface and the ground surface. However, multiple phases can be used if you want to calculate cut and fill between multiple surfaces. The earthworks report is helpful for viewing the breakdown by element regions, as it has a diagram above each element breakdown table.

- **Breakdown by Region:** If volume region elements exist in a phase, a breakdown by region will be completed. A region within a region will be handled by first calculating the outer region excluding the inner region and then calculating the inner region separately.

**Notes on Earthworks Estimation 2D and 3D Areas :** 2D and 3D areas in the earthwork estimation spreadsheet relate to the earthworks footprint (sometimes referred to as the area of disturbance). For the area and perimeter of

the element boundaries refer to the input data spreadsheet. The 2D areas reported are the same as if measured from a paper plan. The 3D areas take into account the surface area of the topography and therefore will always be the same or larger than the 2D areas.

### **Cross Section Spreadsheet**

A separate tab/sheet will appear for each phase. Each sheet shows sections top to bottom. There are five column headings: *Section Name*; *Segment Number* (meaningful for long sections); *Distance* (each value is relative to the start position); *Existing Level* and *Proposed Level*. Blank rows separate proposed elevations from existing, which are in row separated groups to make chart creation easier. When creating a graph in your favourite spreadsheet editor, select data and headings from the last three columns. Insert a chart and ensure it is a Scatter graph. We suggest 'XY Scatter' & 'Lines Only' in LibreOffice Calc; 'Scatter' & 'Scatter with Straight Lines' in MS Office Excel.

---



[Exports - Report & Spreadsheets](#) video describes the main sections of a typical spreadsheet.

---

---

# Chapter 18

---

## Exporting Images & Drawings

---

### Topics:

- [Creating Drawings](#)
- [Export Image](#)
- [Export to LandXML](#)

When it comes to presenting the results of a project to a client, colleague or other stake-holder, *Kubla Cubed* has a number of options available:

- **Drawings:** Summary drawings can be presented of the project, showing a plan view of each phase, as well as the summary volumes and any transects that have been defined. These drawings can be exported either to a PDF file or to various CAD file formats. For more information see [Creating Drawings](#).
- **LandXML Data:** A lot of the project data can be exported to this specialist land surveying file format. LandXML is a popular data transfer format used to import/export line-work, survey points and surfaces. Like the CAD data, LandXML can also be used to import data into machine control systems. For more information see [Exporting LandXml Data](#).
- **Images:** Images showing the design area can be exported to a several file formats. The images can display the shaded terrain and earthworks, and can optionally include grid lines, colour keys and contour lines. For more information see [Creating Images](#).

Within the program the options for presenting the above data are contained within the File menu. Here you will find the Create Spreadsheet, Create Report and Create Drawing sub menus. For CAD Data and LandXML Data use the Export menu.

## Creating Drawings

The project data in Kubla Cubed can be presented as drawings which can be saved either to PDF or to various CAD file formats. These drawings will include plan views of each phase you export, as well as colour keys, earthworks quantity summary tables and transects, if you have defined any.

To create a drawing, click on File, Create Drawing and then PDF or CAD.

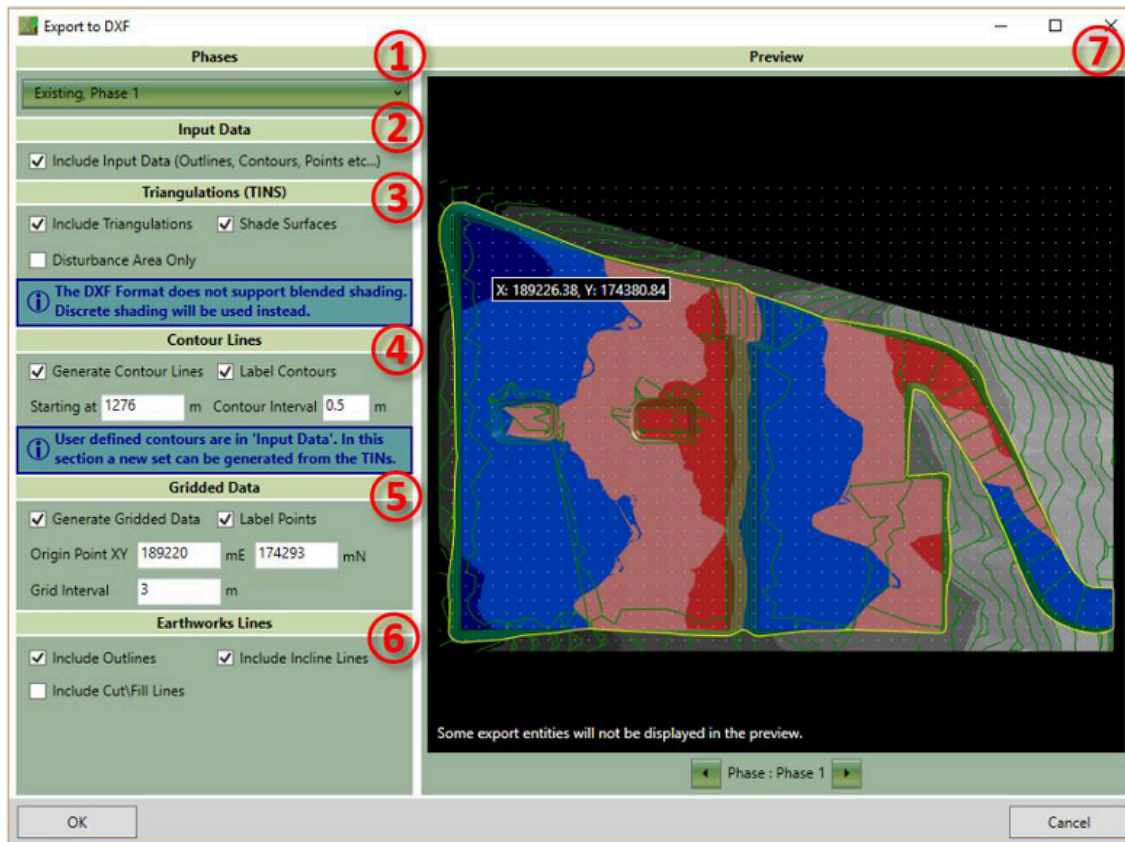

The available options on this form are described below:

- ① The phases drop-down allows you to select which phases are to be included in the drawings. By default, only the selected phase and the existing phase are included. In the file layers are used to separate the entities by phase.
- ② In this section you select whether the drawings should include the data that the user has input into the project (contours, points boundaries etc...).
- ③ In this section you can choose whether to include the TINS in the drawings. Often the TINS are not required if you are just interested in a contour line or gridded data visualisation.
  - Disturbance Area Only In some scenarios when exporting proposed surfaces, you will not want the undisturbed ground in the drawings.
- ④ In this section you can choose to generate surface contour lines. Be aware that contour lines that have been used to define 'Feature Surfaces' in Kubla Cubed will be included if 'Input Data' is checked and are not the contour lines referred to in this section. The contour lines in this section are an entirely new set that can be generated from the entire proposed surface.
  - Label Contours You can choose to turn off the labelling of contour lines.
  - Starting At In this box you can set what level the contour lines start at, it is advised to start on a round number. The default will be set to the bottom of the surface rounded down.
  - Contour Interval In this box you can set the interval distance between each contour line. Very small contour intervals can cause large export times and large file sizes.



- ⑤ As well as generating contour lines from the TINS, you can also include gridded data. It also can be used to create a cut/fill plan for site engineers, or for presenting results to people who are accustomed to using the grid method for calculations.
  - Label Points You can choose to turn off the labelling of points as it saves space in the file. It is recommended you keep this on, as the points will have little meaning otherwise.
  - Origin Point In this box you can set the location of the origin point. The grid will extend out from here in all directions until it exceeds the extents of the surface. It is recommended that rounded numbers are used. By default, it is set to the bottom left rounded to a whole number.
  - Grid Interval In this box you can set the distance between each grid point. Very small grid intervals can cause large drawing generation times and large file sizes.
- ⑥ Earthworks linework created by Kubla Cubed can also be included in the drawings.
  - Outlines The outlines of the earthworks can be included, this can be useful for knowing the location of designed features such as building pads, roads, ponds etc...
  - Incline Lines Kubla Cubed generates 'incline lines' to mark the generated side slopes joining earthworks elements to the ground. You can choose to include these in the drawings.
  - Cut\Fill Lines The lines can be exported in red and blue which show the earthworks cut\fill boundaries.
- ⑦ The preview can be used to give a good indication of what the drawing file will contain. It is especially useful for previewing the density of the generated gridded data and generated contour lines. Please note that this is a preview of the data only, and your drawings will not appear as they are presented here. When multiple phases are selected for inclusion you can cycle through which phase to preview using controls that will appear at the bottom of the preview panel. Multiple phases are not previewed all together to avoid confusion.

Once the drawing settings have been finalised click OK. You will be prompted for the location to save your drawings.

## Export Image

---

Images showing the design area can be exported to a several file formats, including .bmp, .jpg and .png. These images can display the shaded terrain and platforms, and can optionally include grid lines, colour keys and contour lines.

To export an image, click on File, Create Drawing and then Image. The export window will appear, like the one shown below.

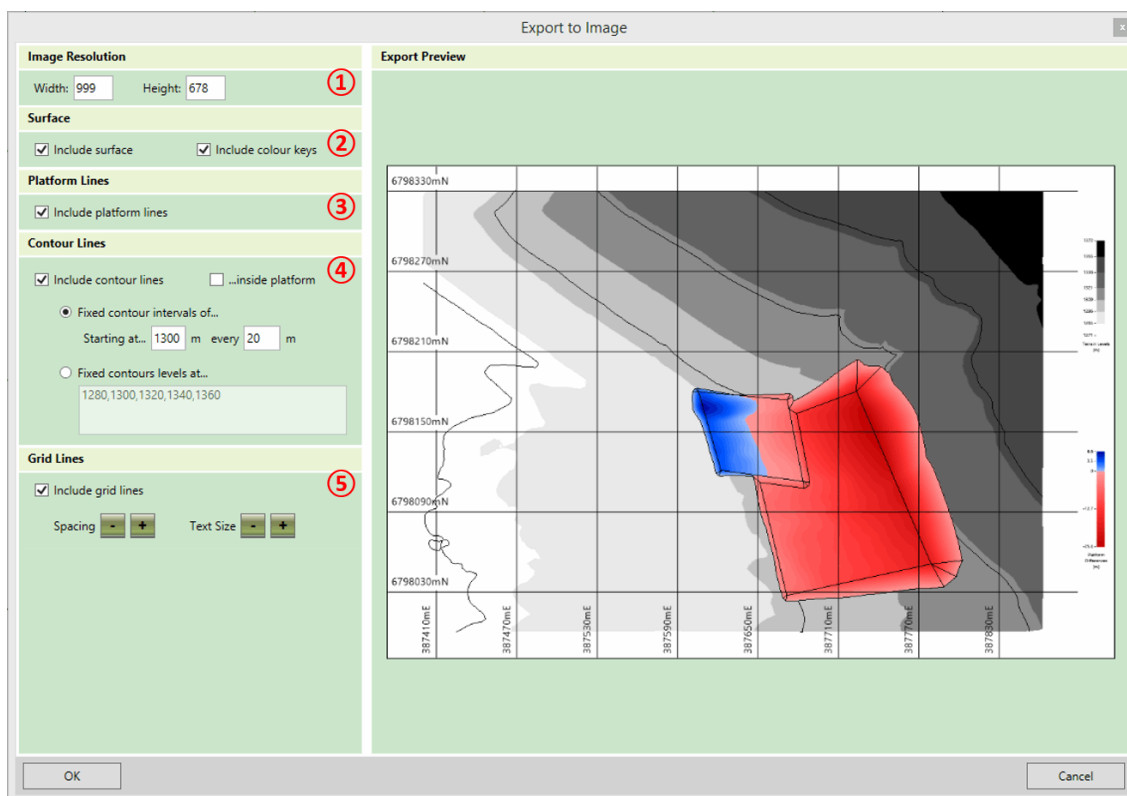

The export options on this form are described below:

- ① This section is where the resolution of the image is defined. If you need a higher quality image then the resolution can be increased, but it will take longer to generate the image and the file size will be larger. Note that the aspect ratio of the export image is fixed, so if you adjust either the width or the height the other dimension will be updated automatically.
- ② In this section you can indicate whether or not you want to include the shaded surfaces in your export, and if you do, you can also indicate whether or not you wish to include colour keys beside the image. If you choose to include surfaces then the shading in the export will be the same as the shading in the main window.
- ③ In this section you can indicate whether or not you want the platform slope lines to be included in the image export.
- ④ In this section contour line options are defined. In the first two check boxes you can indicate whether you want to include contour lines in the export image, and if you do, whether or not contour lines should be shown inside the platforms. Otherwise they will only be shown on the existing terrain. If contour lines are to be drawn you must also specify which level the lines should be drawn at, using one of the following methods:
  - Fixed Contour Intervals of... If this option is selected then contour lines will be shown with fixed intervals e.g. to draw contour lines every 20m. With this option you can also specify a level to start the contour lines from. Use this if you want to ensure that a contour line is drawn at a particular level, such as 0m. Note that contour lines will be drawn both above and below this starting line at the specified interval to cover all of the ground.
  - Fixed Contour Levels at... If this option is selected then the levels of each contour line can be specified by typing into the box, allowing for contour lines to be drawn at irregular intervals. Contour level values which are typed must be separated by a comma.
- ⑤ In this section you specify options for grid lines. In the first check box specify whether or not you want grid lines to be included. If grid lines are to be included, then the grid line spacing and the text size for grid lines can be increased or reduced by clicking on the + and - buttons.

Once the export settings have been finalised click OK. You will be prompted for the location to save the export file and the file format to save.

**Notes on 3D View Images :** The image export can only produce images in the design view. To export an image of the project in one of the 3D views it is best to use the windows snipping tool after putting the program into Presentation

Mode. Within the program switch to one of the 3D views and navigate to the position you want. Then from the Display menu select Presentation Mode. Use the windows snipping tool to take a screen capture of the area that you want and then exit presentation mode by hitting the Esc key. For instruction on how to use the snipping tool refer to [Windows Support : Use Snipping Tool to capture screenshots](#) .



Numerous image export customisations are discussed in our video [Exports - Images](#). Capture of 3D views using the Windows Snipping Tool is [demonstrated](#) later in the video.

## Export to LandXML

The project data in Kubla Cubed can be exported to LandXML. LandXML is a widely supported format used for transferring engineering and surveying data between different programs. Many specialist software applications can import/export this format, visit [www.landxml.org](http://www.landxml.org) for an extensive list of software that can import/export LandXML. LandXML is the recommended method for transferring TINS between Kubla Cubed and other programs.

When developing workflows for use with machine control systems it is sometimes necessary to use LandXML and CAD exports in tandem. Typically, LandXML for the TINS and CAD for the linework.

To export project data to LandXML click on File, Export and then LandXML. The LandXML export window will appear as shown below.



The available options on this form are described below:

- ① The phases drop-down allows you to select which phases are exported to LandXML. By default, only the selected phase is exported. Unlike CAD, LandXML does not have a layer system so it is advantages to only export the data you need to avoid the confusion of having a long list of objects that aren't required.

- ② In this section you select whether the export should include the data that the user has input into the project (contours, points boundaries etc...). For many workflows this information is somewhat redundant and only the TINs are needed, however it can be useful in other design programs.
- ③ In this section you can choose whether to include the TINs in the export. TINs are the best way of transferring surfaces from Kubla Cubed to another program so you should usually keep this option checked.

**Disturbance Area Only** In some scenarios when exporting proposed surfaces, you will not want the undisturbed ground in the model. If for instance you were exporting a surface for use in another cut/fill analysis you would only want the elevations in the disturbance area only.

- ④ In this section you can choose to generate surface contour lines. Be aware that contour lines that have been used to define 'Feature Surfaces' in Kubla Cubed will be included if 'Input Data' is checked and are not the contour lines referred to in this section. The contour lines in this section are an entirely new set that can be generated from the entire proposed surface.
  - **Starting At** In this box you can set what level the contour lines start at, it is advised to start on a round number. The default will be set to the bottom of the surface rounded down.
  - **Contour Interval** In this box you can set the interval distance between each contour line. Very small contour intervals can cause large export times and large file sizes.
- ⑤ As well as generating contour lines from the TINs you can also export gridded data. This can be useful for importing into other programs that do not support TIN import. It also can be used to create a cut/fill plan for site engineers.
  - **Origin Point** In this box you can set the location of the origin point. The grid will extend out from here in all directions until it exceeds the extents of the surface. It is recommended that rounded numbers are used. By default, it is set to the bottom left rounded to a whole number.
  - **Grid Interval** In this box you can set the distance between each grid point. Very small grid intervals can cause large export times and large file sizes.
- ⑥ Earthworks linework created by Kubla Cubed can also be included in the LandXML format.
  - **Outlines** The outlines of the earthworks can be exported, this can be useful for knowing the location of designed features such as building pads, roads, ponds etc...
  - **Incline Lines** Kubla Cubed generates 'incline lines' to mark the generated side slopes joining earthworks elements to the ground. You can choose to include these in the file.
  - **Cut/Fill Lines** The lines can be exported in red and blue which show the earthworks cut/fill boundaries.
- ⑦ The preview can be used to give a good indication of what the exported file will contain. It is especially useful for previewing the density of the generated gridded data and generated contour lines. Please note that not all entities will show in the preview. When multiple phases are selected for export you can cycle through which phase to preview using controls that will appear at the bottom of the preview panel. Multiple phases are not previewed at together to avoid confusion.

Once the export settings have been finalised click OK. You will be prompted for the location to save the LandXML file.



Our [Working with LandXML Files \(.xml\)](#) video starts by looking at importing existing and proposed surfaces from LandXML using Triangle Surfaces. It then covers the options for exporting a Kubla Cubed project to a LandXML file.

---

---

# Chapter 19

---

## Export to CAD

---

### Topics:

- [CAD Export Options](#)

The project data in Kubla Cubed can be exported to an CAD (.dwg, .dxf) file. These are a widely supported formats used for transferring engineering and surveying data between different CAD programs. Using the data exported from Kubla Cubed a CAD technician can produce PDF files of the Kubla Cubed data for distribution or combine with other CAD data of the site to create complex drawings. For instance, the gridded data could be overlaid on the original site plan to produce a detailed visualisation of the cut\fill.

When developing workflows for use with machine control systems it is sometimes necessary to use LandXML and CAD exports in tandem. Typically, LandXML for the TINS and CAD for the linework.

## CAD Export Options

The project data in Kubla Cubed can be exported to an CAD (.dwg, .dxf) file. These are a widely supported formats used for transferring engineering and surveying data between different CAD programs. Using the data exported from Kubla Cubed a CAD technician can produce PDF files of the Kubla Cubed data for distribution or combine with other CAD data of the site to create complex drawings. For instance, the gridded data could be overlaid on the original site plan to produce a detailed visualisation of the cut/fill.

When developing work-flows for use with machine control systems it is sometimes necessary to use LandXML and CAD exports in tandem. Typically, LandXML for the TINS and CAD for the linework.

To export project data to CAD, click on File, Export and then CAD Data. The CAD export window will appear as shown below.

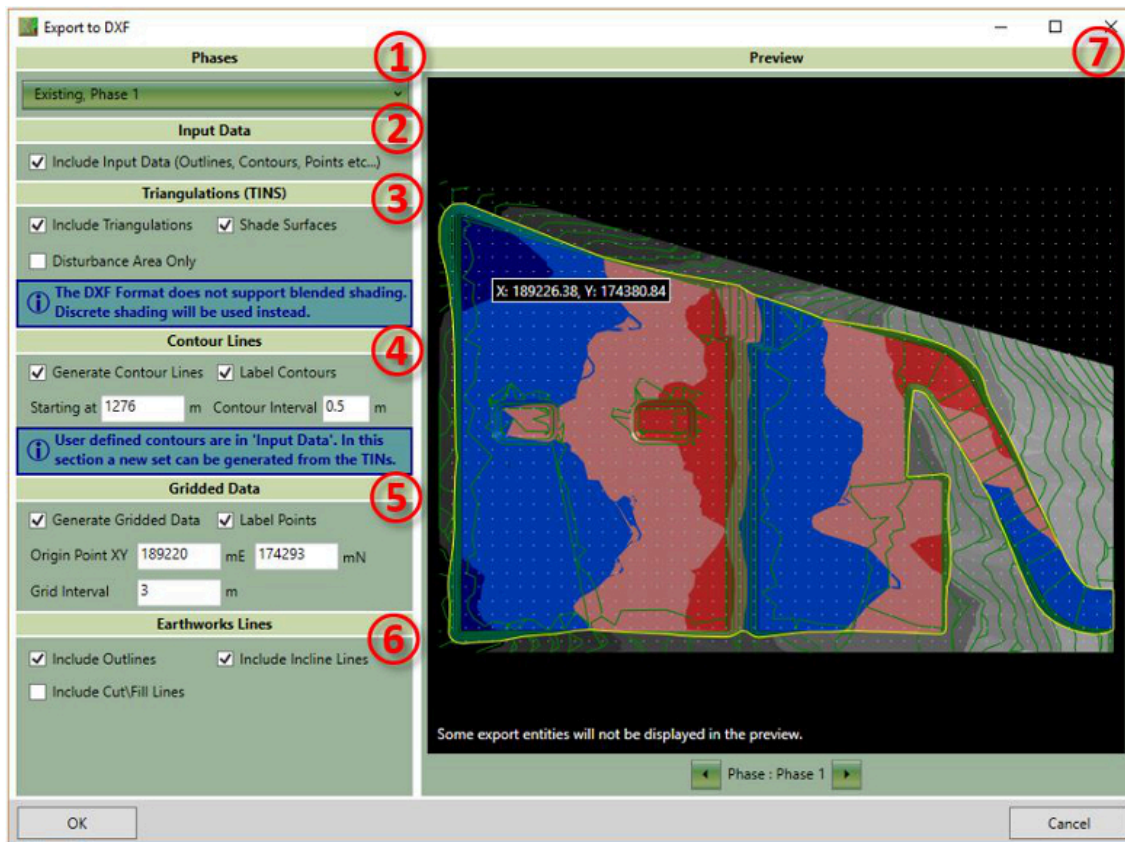

The available options on this form are described below:

- ① The phases drop-down allows you to select which phases are exported to CAD. By default, only the selected phase and the existing phase is exported. In the file layers are used to separate the entities by phase.
- ② In this section you select whether the export should include the data that the user has input into the project (contours, points boundaries etc...).
- ③ In this section you can choose whether to include the TINS in the export. Often the TINS are not required if you are just interested in a contour line or gridded data visualisation.
  - Disturbance Area Only In some scenarios when exporting proposed surfaces, you will not want the undisturbed ground in the model. If for instance you were exporting a surface for use in another cut/fill analysis you would only want the elevations in the disturbance area only.
- ④ In this section you can choose to generate surface contour lines. Be aware that contour lines that have been used to define 'Feature Surfaces' in Kubla Cubed will be included if 'Input Data' is checked and are not the contour

lines referred to in this section. The contour lines in this section are an entirely new set that can be generated from the entire proposed surface.

- **Label Contours** You can choose to turn off the labelling of contour lines, however as CAD has a special entity for this exact scenario it is recommended it is left turned on.
- **Starting At** In this box you can set what level the contour lines start at, it is advised to start on a round number. The default will be set to the bottom of the surface rounded down.
- **Contour Interval** In this box you can set the interval distance between each contour line. Very small contour intervals can cause large export times and large file sizes.
- ⑤ As well as generating contour lines from the TINs, you can also export gridded data. This can be useful for importing into other programs that do not support TIN import. It also can be used to create a cut\fill plan for site engineers.
  - **Label Points** You can choose to turn off the labelling of points as it saves space in the file. Be aware that points without labels will only be useful as an import into other programs, gridded points with no labels in a CAD drawing would have little meaning.
  - **Origin Point** In this box you can set the location of the origin point. The grid will extend out from here in all directions until it exceeds the extents of the surface. It is recommended that rounded numbers are used. By default, it is set to the bottom left rounded to a whole number.
  - **Grid Interval** In this box you can set the distance between each grid point. Very small grid intervals can cause large export times and large file sizes.
- ⑥ Earthworks linework created by Kubla Cubed can also be included in the CAD export.
  - **Outlines** The outlines of the earthworks can be exported, this can be useful for knowing the location of designed features such as building pads, roads, ponds etc...
  - **Incline Lines** Kubla Cubed generates 'incline lines' to mark the generated side slopes joining earthworks elements to the ground. You can choose to include these in the file.
  - **Cut\Fill Lines** The lines can be exported in red and blue which show the earthworks cut\fill boundaries.
- ⑦ The preview can be used to give a good indication of what the exported file will contain. It is especially useful for previewing the density of the generated gridded data and generated contour lines. Please note that not all entities will show in the preview. When multiple phases are selected for export you can cycle through which phase to preview using controls that will appear at the bottom of the preview panel. Multiple phases are not previewed all together to avoid confusion.

Once the export settings have been finalised click OK. You will be prompted for the location to save the DXF file.



Our [Exports - CAD Files](#) video describes and demonstrates the options for customising CAD exports.

---





---

# Chapter

# 20

---

## Export to BIM and/or Machine Control

---

### Topics:

- [Exporting for BIM Software](#)
- [Exporting for Machine Control Systems](#)

BIM stands for Building Information Modelling and is intended to make the construction process more efficient by recording data in regard to a buildings construction and ongoing maintenance. An effort is also underway to establish open standards so widespread sharing of this data is possible between stake holders. Kubla Cubed cannot export directly to a BIM format (e.g IFC) however the topography and positional data produced in Kubla Cubed can be exported and then imported into those systems.

Machine Control systems consist of hardware and software that is installed on earthmoving equipment that can give the operator a visual on where to excavate, this can be both 2D and in 3D. Like BIM Kubla Cubed cannot export directly to the propriety formats used on the systems of various manufacturers. However it can export data which can then be imported into the software provided by the manufacturers for making machine control files.

In this chapter we will look at some of the options for exporting Kubla Cubed data to BIM and Machine Control.

## Exporting for BIM Software

Most BIM systems support the import of data using CAD files (e.g. .dwg, .dxf) so this is the best option for importing linework (earthworks definition boundaries, measurement positions, lengths and areas etc..). You can do this by selecting **File** from the menu bar and then **Export>CADDData**.

When it comes to the topography things get a bit more complicated. Kubla Cubed uses TINS for calculating and storing topography and so if a BIM program also supports TINS then this is the best way to import the data. However some BIM systems do not support TIN or slightly more confusingly some will take the points from the TIN but not the triangle data so the surface actually changes when imported. In both these situations if a BIM software does not support TIN then you can export the surfaces as either a high density point cloud or contour lines.

To do this select the following options from **File>Export>CAD Datascreen** to generate gridded points to go into the BIM system. The image below shows which options to choose.

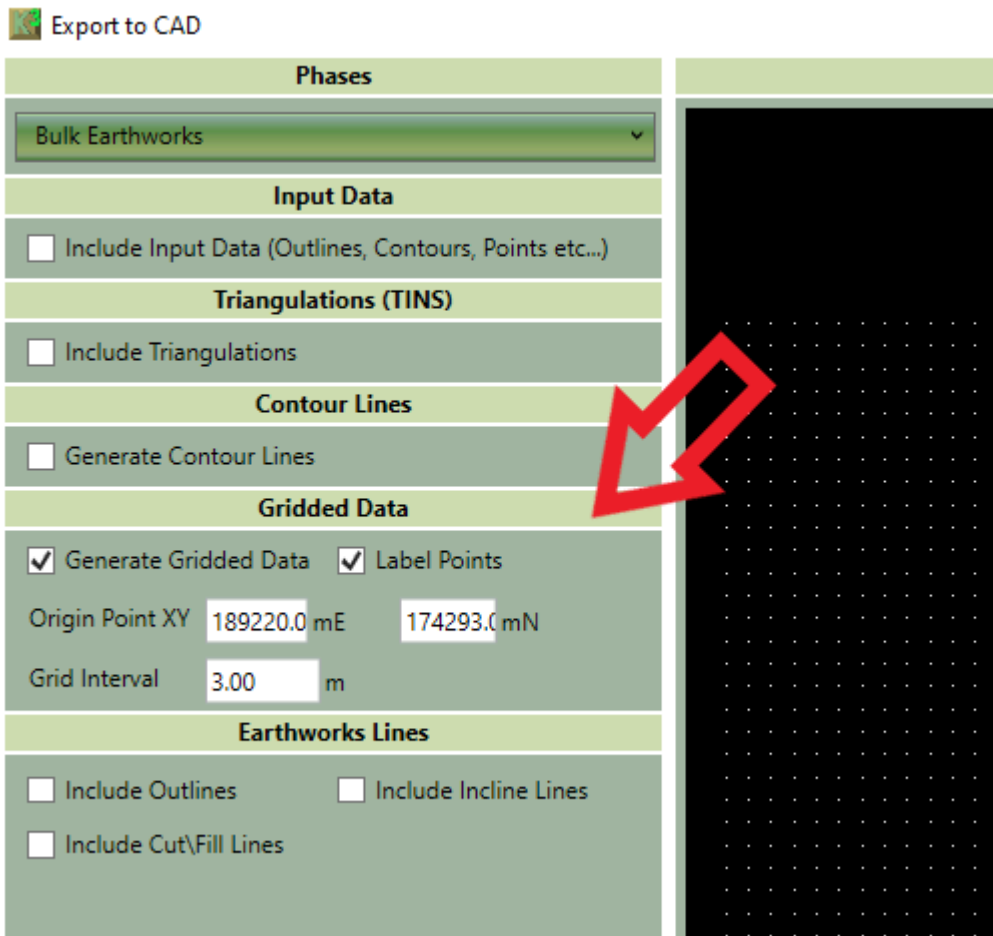

## Exporting for Machine Control Systems

Each producer of machine control systems has their own software for preparing a file which can then be uploaded to the earthmoving machinery.

A lot of the software products support import of both CAD (.dwg, .dxf) and Land XML (.xml) files. You can therefore export all your data to either of those formats and it should import.

**File>Export>CAD Data**

or

### **File>Export>Land XML**

Sometimes machine control works better with one format over another. It has been suggested that for line work, CAD files work better and for TINS, Land XML files are better. However it is easier to stick to one file format unless there are problems.

Some older machine control systems might not support TINS but do support point clouds. In that situation you will need to generate gridded data in the same way as suggested for BIM Software that does not support TIN.



---

# Chapter 21

---

## Troubleshooting

---

### Topics:

- [Essential Project Checks](#)
- [Error Messages in Kubla Cubed](#)

The troubleshooting section provides some quick tips and also more detailed explanation of how validation works in Kubla Cubed, which will help you find your own solutions to common problems.

This troubleshooting section also introduces the error/warning messages you may encounter. For example, suppose the intention is to model a site spanning 300m. You would be presented with a warning if you accidentally set the site size to 300mm!

## Essential Project Checks

---

### Project Checks

A computer model can only be as good as the data input to it; a frequently used industry phrase is 'GIGO' (Garbage In Garbage Out). Therefore, checking your input is essential to ensure that no mistakes have been made during the various steps. The checks should be made after the data is input (e.g check the site plan after it has been imported). However, we also recommended the following checks are done at the end of each project before producing reports...

#### 1. Site Plan Scale Check

Check that dimensions in site plan are correct. Press and hold the 'M' key on your keyboard, then drag your mouse from start to end over a known length. If the value matches that on the site plan, then you have scaled correctly. Be sure to pick a long length for comparison to remove the potential of small inaccuracies going un-noticed.

Alternatively, you can use the 'Length' Measurement element. This can be found by double clicking on the 'Measurements' panel in the right-hand side of the program. For instructions, see our [Count, Length and Area Measurements](#) video. The added benefit of this method is that the element stays in place and can be referenced each time new site plan edits are made, helping ensure nothing becomes 'broken' without being noticed.

#### 2. CAD data Import Units Check

Check that the units in you CAD import, match the units used in your Kubla Cubed units setup. The importer has a units option and you can also change the Measure units from the main menu.

#### 3. Elevation Spot Check

Going back to check each point height would be a laborious effort. However, you can change the cursor options to show the XYZ values and then mouse over. To do this, from the menu, select 'Measure'. Within the sub menu 'Cursor', select the option *X: Y:* and then *Z(proposed):* and/or *Z(existing):* . Now, when you mouse over terrain, the selected dimension values will show beneath the cursor.

#### 4. Elevation Cross Section Check

Draw a cross section line across your site. View the graph within Kubla Cubed and check where the proposed line rises above and falls below the existing. Moving the mouse across the graph, you can also check individual sections are precisely as expected under the cursor.

#### 5. Vertical Exaggeration Check

To help check for incorrect Z values and to a lesser effect XY values, exaggerate the terrain height... Change to one of the 3D cameras to show the Vertical Exaggeration Tool. Move the tool's slider up/down to highlight obvious mistakes such as height spikes.

#### 6. Input Validation Check

Once all you data has been input, from the main menu select 'Create Spreadsheet' and then select 'Input Data'. Check that the Spreadsheet contents match your original input data.

## Error Messages in Kubla Cubed

---

All software will give error messages from time to time and Kubla Cubed is no different. In this post we discuss the 'Calculation Error' message which can sometimes occur when working on complex projects. We also discuss the Kubla Cubed's calculation steps and the error reporting features. This section contains discussion of quite advanced topics and is therefore targeted at experienced users.

### Overview

Calculation error messages are displayed in Kubla Cubed where the calculations fail, or where a validation step fails. Validation steps are run at numerous points during the calculation to ensure the integrity of the final result. No calculation engine is going to be entirely free of errors, and especially not one whose calculations are based

on Triangular Prisms, like Kubla Cubed. This method is the most accurate, but is also far, far more technically challenging than the grid and cross-section methods that are used by some other earthworks software. Kubla Cubed allows users to create as many phases of work as they wish, with each phase containing an unlimited number of earthworks elements. This provides a great deal of flexibility to our users. However, it also allows for very complex projects to be defined, increasing the likelihood of calculation errors when compared to more restrictive software.

### Calculation Steps

In order to understand the sources of calculation errors, it helps to understand the steps involved in the calculation. We will briefly summarise the process below. These steps are repeated for each phase in the project.

For each earthworks element in a phase, there is a three step process:

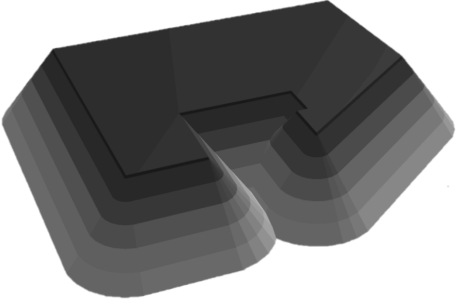
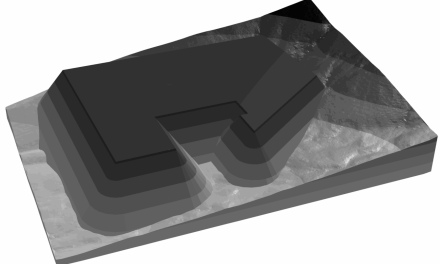
<p><b>Step one</b></p> <p>Generating the surface mesh. For a platform, this is trivial and unlikely to cause an error. However, it is potentially quite complicated for a feature surface with many ground features. It can also be challenging for a strip or overlay, where the ground below is complex.</p>	
<p><b>Step two</b></p> <p>Generating batter slopes. These are the side slopes that will be used to connect the surface mesh to the terrain. The complexity of this process depends largely on the complexity of the outline of the element. However, if the batters are set to vertical this step is quite straightforward for the software to complete.</p>	
<p><b>Step three</b></p> <p>Merging the element with the terrain. This is usually a fairly challenging step for the software, particularly if the existing and/or proposed meshes are complex.</p>	

Once all of the earthworks elements have been processed in this way, there will be 2 meshes; the mesh at the start of the phase, and the mesh after all the elements have been merged into it. The final step is to project the initial mesh edges onto the final mesh. This will create a mesh which contains all the edges of both the initial and the final meshes. This 'Calculation Mesh' is used to generate volumes and to present cut and fill maps. This final step of the process is extremely complex and is one of the most common sources of error.

If an error occurs when merging an earthworks element into the terrain, the software will identify the element that caused the error. However, if an error occurs when generating the calculation mesh, it is not possible to identify a specific element that has caused the problem. For this reason, these errors can be particularly difficult for our customers to resolve with the current error messages.

### General Approach

At Kubla, we use the following approaches to minimise the frequency and impact of calculation errors:

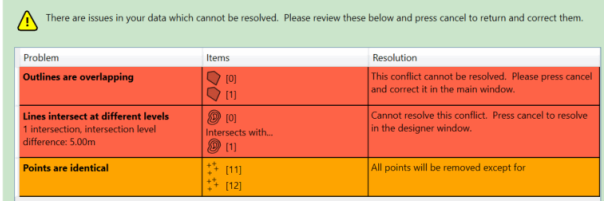
<ul style="list-style-type: none"> <li>• Thorough validation of the data that is input by the user. This minimises the likelihood of situations that will cause errors.</li> <li>• Continual improvement to make the calculations as robust as possible. Our developers are constantly working through calculation errors reported by users; fixes are included in regular software updates.</li> <li>• Presenting error details to the user about errors when they occur, to enable them to resolve the issues themselves.</li> <li>• Directly supporting customers who run into calculation errors.</li> </ul>	 <table border="1"> <thead> <tr> <th>Problem</th> <th>Items</th> <th>Resolution</th> </tr> </thead> <tbody> <tr> <td><b>Outlines are overlapping</b></td> <td>[0] [1]</td> <td>This conflict cannot be resolved. Please press cancel and correct it in the main window.</td> </tr> <tr> <td><b>Lines intersect at different levels</b> 1 intersection, intersection level difference: 5.00m</td> <td>[0] Intersects with... [1]</td> <td>Cannot resolve this conflict. Press cancel to resolve in the designer window.</td> </tr> <tr> <td><b>Points are identical</b></td> <td>[11] [12]</td> <td>All points will be removed except for</td> </tr> </tbody> </table>	Problem	Items	Resolution	<b>Outlines are overlapping</b>	[0] [1]	This conflict cannot be resolved. Please press cancel and correct it in the main window.	<b>Lines intersect at different levels</b> 1 intersection, intersection level difference: 5.00m	[0] Intersects with... [1]	Cannot resolve this conflict. Press cancel to resolve in the designer window.	<b>Points are identical</b>	[11] [12]	All points will be removed except for
Problem	Items	Resolution											
<b>Outlines are overlapping</b>	[0] [1]	This conflict cannot be resolved. Please press cancel and correct it in the main window.											
<b>Lines intersect at different levels</b> 1 intersection, intersection level difference: 5.00m	[0] Intersects with... [1]	Cannot resolve this conflict. Press cancel to resolve in the designer window.											
<b>Points are identical</b>	[11] [12]	All points will be removed except for											
<p>We believe that our validation, calculations and support are amongst the best available in the industry, although we continue to improve these areas. However, it has become clear that our users are often finding that when error messages occur they are difficult to make sense of and do not always provide enough information for them to find a solution on their own. For this reason, the latest release of the software includes work to improve this aspect of the software. This work is ongoing and will continue in subsequent updates.</p>	<p>The validator in Kubla Cubed aims to prevent errors in the terrain definition. It will block blatant errors, such as contour lines crossing each other with different levels. It will also warn the user about likely errors, such as one elevation which is very different from all of the others.</p>												

### Improvements to Error Reporting

In earlier versions of the software, only one error message could be displayed to the user. This provided limited ability for our developers to communicate the source of the error to the user of the software. One major upgrade to error reporting is to present the full error path to the user, which allows for much more detail about the error to be communicated to the user.

However, the most significant improvement to error reporting is the ability to display the region in which the error has occurred on the screen. This allows our users to inspect the problem area, and see if they have made any mistake, or if they could simplify the way they have defined the ground levels in this area. Sometimes even just moving some features in this area by a negligible amount may cause errors to go away.

However, it's important to understand, that due to the complexity of the calculations it's not always obvious where they have initially gone wrong. The error regions displayed will sometimes represent a 'best guess' of the location of the source of the error. The project should be checked in the vicinity of the identified error region, as well as within the region itself. It should also be noted that it is not possible to identify an error region for every type of error, and it will not always be displayed. However, the most common errors will now have error regions, and coverage will be expanded to more error types in the future.



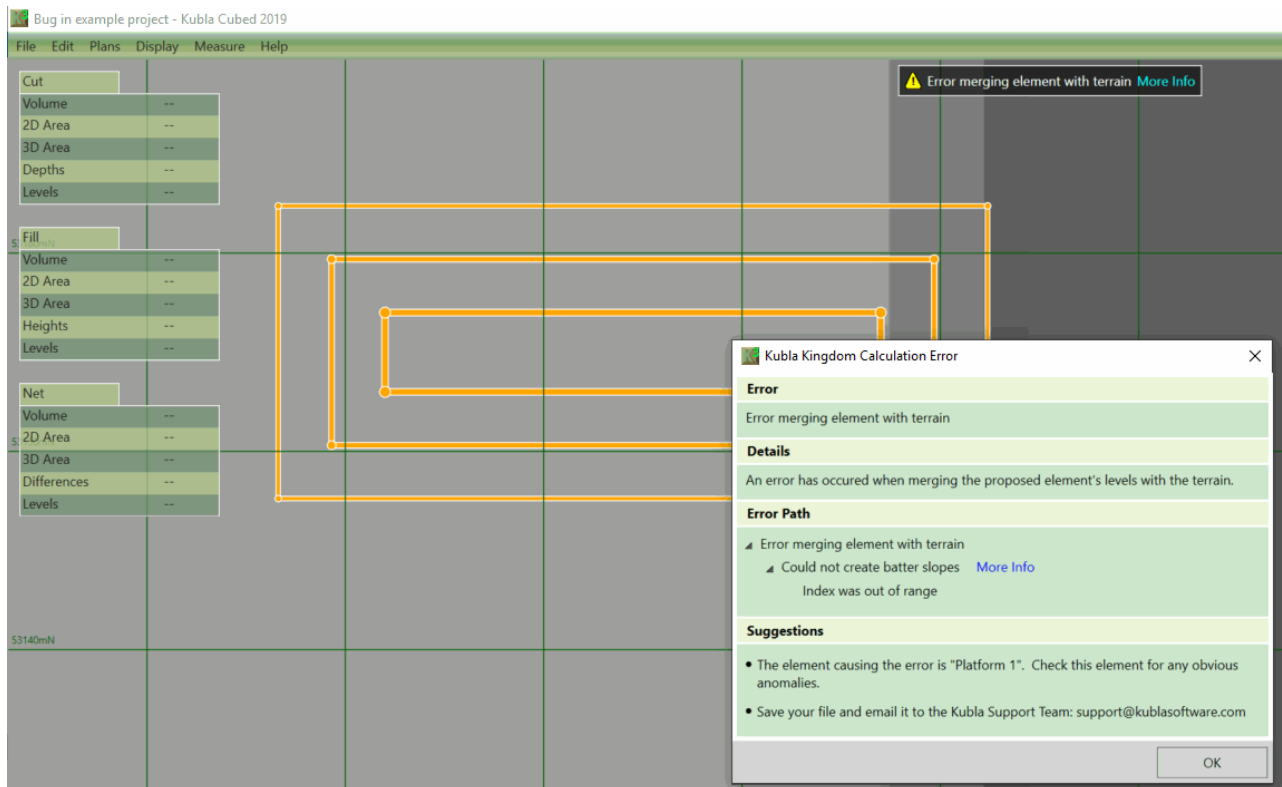

**The ability to view the error region, as well as the full error path are two significant upgrades to error reporting in Kubla Cubed**

Source: *Error Messages in Kubla Cubed* was originally in the Kubla blog

