

# **Kubla Cubed User Manual**

## **Version 7.0**



# Contents

<b>Chapter 1: Introduction.....</b>	<b>7</b>
Kubla Software.....	8
Kubla Cubed.....	8
<b>Chapter 2: Getting Started.....</b>	<b>9</b>
User Interface.....	10
Setting the Correct Units.....	11
Changing Background Colour.....	12
Cursor Label.....	13
Navigation.....	13
Undoing and Redoing Changes.....	16
Selecting Elements.....	16
Loading and Saving Files.....	17
Loading Projects.....	17
Saving Projects.....	17
Auto-Recovery.....	18
Keyboard Shortcuts / Hotkeys.....	20
<b>Chapter 3: Display.....</b>	<b>21</b>
Display Panel.....	22
Lighting.....	22
Line Work.....	23
Earthworks Shading.....	23
Site Plan Visibility.....	23
Element Shading.....	24
On-Screen Statistics.....	25
Single Camera Mode.....	26
Presentation Mode.....	26
Colour Keys.....	26
Vertical Exaggeration.....	28
<b>Chapter 4: Site Plans.....</b>	<b>31</b>
Overview.....	32
Quick Measure Tool.....	33
Editing Modes.....	33
Adding a Site Plan.....	34
Setting the Position and Cropping.....	34
Move.....	35
Rotate.....	36
Scale.....	36
Align to Two Points.....	37
Crop.....	37
Stitching Site Plans.....	37
Overlaying Site Plans.....	38
Setting the Transparency.....	39
Setting Visibility.....	40

<b>Chapter 5: Construction Phases.....</b>	<b>43</b>
Overview.....	44
<b>Chapter 6: Elevation Elements.....</b>	<b>47</b>
The Elements Panel.....	48
Calculation Order.....	51
Side Batters.....	52
Absolute Elements.....	53
Platform Element.....	54
Slope Element.....	55
Path Element.....	57
Feature Surface Element.....	58
Triangle Surface Element.....	59
Relative Elements.....	59
Reduce Element.....	60
Raise Element.....	61
Trench Element.....	61
Berm Element.....	62
<b>Chapter 7: Measurement Elements.....</b>	<b>65</b>
The Measurements Panel.....	66
Count Element.....	69
Length Element.....	69
Area Element.....	70
Volume Region Element.....	70
Volume Region - Batch Create.....	71
RICS NRM2 (2013+).....	72
RICS SMM7 (< 2013).....	73
Validation Failed.....	74
Cross Section Element.....	74
<b>Chapter 8: Editing Elements.....</b>	<b>77</b>
Feature Types.....	78
Adding New Features.....	79
Adding Features Manually.....	80
Adding Features from a PDF/CAD File.....	82
Adding Points from a Data File.....	85
Editing and Deleting Features.....	86
Group Selection.....	87
Editing Tools.....	88
Join Tool.....	88
Split Tool.....	89
Offset Tool.....	89
Set Multiple Elevation (SME) Tool.....	91
Sort Tool.....	92
Copy and Paste.....	94
Triangle Surface.....	94
<b>Chapter 9: Defining Existing Ground.....</b>	<b>97</b>
Existing Defined with Points, Contour Lines and Break-Lines.....	98



Existing Defined with Triangles.....	101
Existing Boundary Outline.....	102
Lidar and Photogrammetry data.....	102
<b>Chapter 10: Topsoil Stripping.....</b>	<b>105</b>
Reducing a Topsoil Strip by Specified Depths.....	106
Excluding Internal Areas from a Strip.....	107
<b>Chapter 11: Demolition.....</b>	<b>109</b>
Breaking Out Concrete Areas.....	110
Milling Paved Areas.....	110
Calculating the Volume of Demolished Materials.....	111
<b>Chapter 12: Bulk Earthworks.....</b>	<b>113</b>
Bulk Earthworks - Overview.....	114
Adjusting to Subgrade / Formation Level.....	114
Soft Landscape (Ponds, Gardens, External Works, etc.).....	116
Hard Landscape (Building Pads, Drives, Car Parks, etc.).....	117
Recreational Grounds (Golf Course, Sports Pitch, etc.).....	118
Roads and Paths.....	118
Retaining Walls.....	120
<b>Chapter 13: Utility Trenches.....</b>	<b>123</b>
Trenches, Ditches.....	124
<b>Chapter 14: Foundations, Footings.....</b>	<b>127</b>
Modelling Foundations.....	128
Backfilling.....	128
Filling Around Structural Elements.....	129
<b>Chapter 15: Paving, Turf and Sod.....</b>	<b>131</b>
Using Reported Areas to Calculate Paving Volumes.....	132
Using the Raise Element to Report Paving Volumes.....	133
Obtaining a Breakdown of different Paving Strata.....	134
<b>Chapter 16: Marine Dredging &amp; Reclamation.....</b>	<b>135</b>
Coordinates and Bathymetry.....	136
Modelling tools.....	136
Visualisation.....	137
<b>Chapter 17: Stockpile Volumes.....</b>	<b>139</b>
Importing Survey Point File (.CSV, .XYZ, .XLS, .UAV).....	140
Calculate the Volume of the Stockpile - Platform.....	140
Calculate the Volume of the Stockpile - Feature Surface.....	142
<b>Chapter 18: Exporting Spreadsheets &amp; Reports.....</b>	<b>145</b>

Creating Reports.....	146
Creating Spreadsheets.....	147
<b>Chapter 19: Exporting Images &amp; Drawings.....</b>	<b>151</b>
Creating Drawings.....	152
Export Image.....	153
Export to LandXML.....	155
<b>Chapter 20: Export to CAD.....</b>	<b>157</b>
CAD Export Options.....	158
<b>Chapter 21: Export to BIM and/or Machine Control.....</b>	<b>161</b>
Exporting for BIM Software.....	162
Exporting for Machine Control Systems.....	162
<b>Chapter 22: Troubleshooting.....</b>	<b>165</b>
Essential Project Checks.....	166
Software Performance.....	168
Error Messages in Kubla Cubed.....	169

---

# Chapter 1

---

## Introduction

---

### Topics:

- [Kubla Software](#)
- [Kubla Cubed](#)

Welcome to the *Kubla Cubed* user guide. *Kubla Cubed* is a general-purpose volumetric calculation tool. It employs a cutting-edge TIN-based volumetric calculation engine to estimate cut and fill in a diverse range of scenarios. Innovative and powerful design tools are available to complete volume estimates for various scenarios, including site stripping, bulk earthworks, building pads, ponds, roads, retaining walls, stockpiles, marine dredging, and many others. Whether you are performing a complicated take-off from PDF drawings or comparing two surveys, *Kubla Cubed* has all the tools you need to get the job done.

## Kubla Software

---

Kubla Ltd is an engineering software company formed in 2013, with headquarters in Bristol, UK, known for being the home of Britain's most famous engineering accomplishments, including the Clifton Suspension Bridge and the iron-hulled vessel SS Great Britain—both engineered by the celebrated engineer, Isambard Kingdom Brunel.

As an innovative software company, we focus on creating applications for engineering, surveying and construction professionals. Our solutions are utilised globally, on projects that span from the design of dredging works to the everyday production of accurate earthworks bids.

Our software products are developed in-house, by specialists in engineering, surveying and graphical visualisation. We pride ourselves on developing bespoke and off-the-shelf solutions which are both cutting-edge and exceptionally user friendly. By concentrating on software design and support we help our users to focus on engineering problems through effective software solutions.

## Kubla Cubed

---

*Kubla Cubed* provides a range of tools for recording earthwork data and measuring the results. Data can be input manually, extracted from Vector data in PDFs and imported from CAD files. Additionally, there are a variety of export options available to export designs into a CAD or LandXML files or generate images, reports, and spreadsheets for project documentation.

---

# Chapter

# 2

---

## Getting Started

---

### Topics:

- [User Interface](#)
- [Setting the Correct Units](#)
- [Changing Background Colour](#)
- [Cursor Label](#)
- [Navigation](#)
- [Undoing and Redoing Changes](#)
- [Selecting Elements](#)
- [Loading and Saving Files](#)
- [Keyboard Shortcuts / Hotkeys](#)

Within this section, you will discover the various components of the application and gain insights into how to interact with them.

## User Interface

The quickest way to get started with *Kubla Cubed* is to open an example file. When you click on File and then Open you will see a list of example files which you can start with. Once you have opened a file, the window will appear as shown below:



This image shows the Elevation Elements menu open. Double click on "Measurements" to open the measurements menu.

The different elements of this user interface are briefly described below:

- ① Design Area - This is the main display where the existing ground and the proposed earthworks will be displayed.
- ② Elevations Panel - This panel is used for adding, removing and editing the earthworks elements, which are combined together to create a proposed surface.
- ③ Measurements Panel - This panel is used for adding, removing, and editing the measurement elements (e.g., Lengths, Areas, Counts). You can open this panel by double clicking on the header "Measurements"

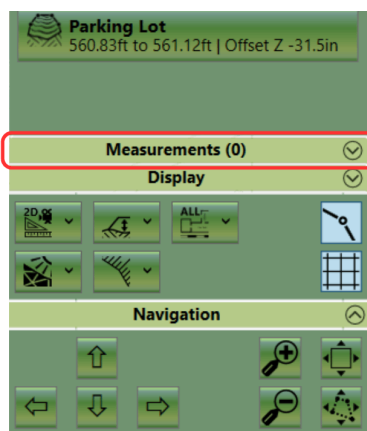

- ④ Display Panel - This panel is used for changing various display options (e.g., camera controls, lighting and grid lines, site plans).
- ⑤ Navigation Panel - The controls in this panel can be used for zooming, panning, and rotating (in 3D) the views.

- ⑥ The Results Panel - The results panel shows an overview of the earthworks estimation for the current phase. A more detailed analysis can be produced in a report or spreadsheet.
- ⑦ The Colour Keys - These colour keys show the shading used to display the existing and proposed topography.
- ⑧ Construction Phases - The bottom of the first tab shows the existing ground; subsequent tabs show phases of proposed earthworks.

### Start your own project

When you are ready to start your own project, the first step is to add your site plans, do this by selecting 'Add PDF/CAD/Image File' from the Plans menu (you can skip this step if working exclusively with CAD or XYZ point files).

To start defining existing elevations, make sure the Existing tab is selected and then in the Elevations panel on the right-hand side click on the + symbol and add a Feature Surface or a Triangle Surface.

This will open a window that allows you to define existing ground elevations or import a triangulated mesh from a file. Once you have done this, you can create and edit proposed earthworks by selecting the Proposed 1 tab and adding earthworks elements such as Platforms, Slopes, Reduce elements or another Feature Surface.



Learn about Kubla Cubed site plans in our video [Site Plans - Overview](#). Become familiar with earthwork estimations tools in [Proposed Levels - Overview](#). Dive into an example project with our [walk-through videos](#). and find stand-alone [video tutorials](#) on our website.

## Setting the Correct Units

*Kubla Cubed* can display either metric or imperial (English) units. These will initially be set to a default value depending on the region settings of the computer. The initial settings can easily be changed by clicking on Settings in the menu bar and then Measurement Units.

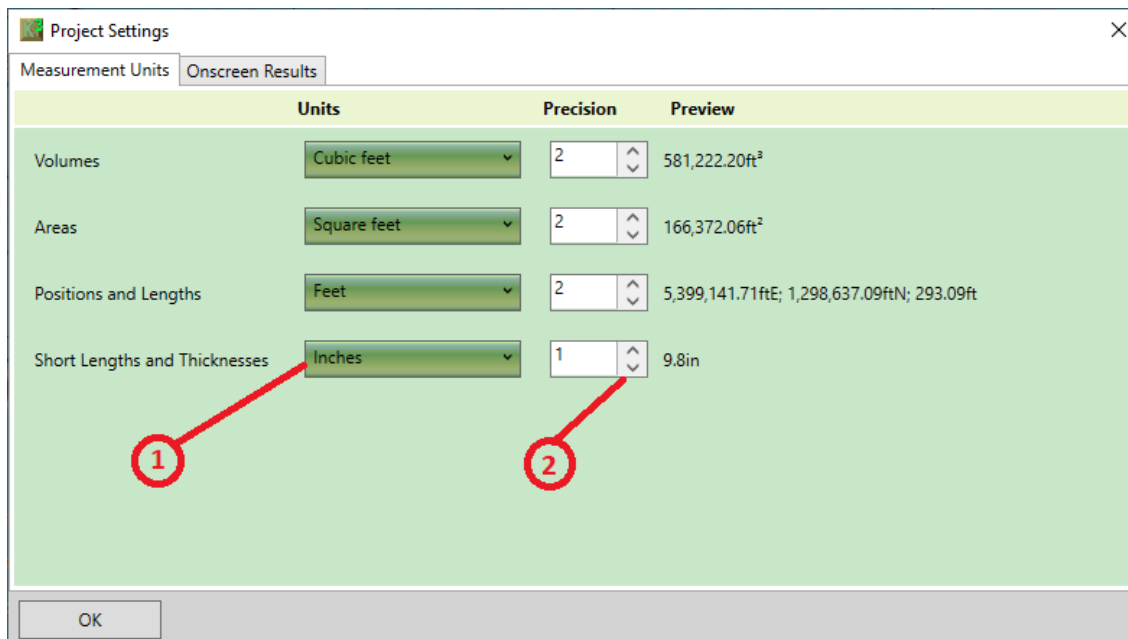

① Units - For each measurement type (volumes, areas, positions and short lengths), you can select the desired unit of measure. It is recommended that you do not mix imperial and metric units together. For instance, if areas and volumes are set to yards, then positions should be set to feet.

② Precision - For each measurement type, you can also change the precision displayed in the program. It should be noted that this has no effect on the calculation engine precision, only the display. The default is two decimal places, which is sufficient for most earthworks projects.

**Notes on Sharing Files :** All Kubla files are saved with the same units internally. The display settings that can be changed in *Kubla Cubed* only affect the way the units are displayed to the user. They do not change how the units are saved internally. This means that if you share a file with another user, the file will display correctly in whatever units they have selected as their preference. This can cause complications if a site plan is marked in different units than what the user has selected; however, if this happens, it is simple to synchronise the display units to match those marked on the site plan using the above options.



View application settings (not project settings) in our video [Kubla Cubed Quick Tip | Change Units of Measure](#).

## Changing Background Colour

Options for changing the background colour can be accessed via the 'Colours' menu and then selecting 'Background'. The colour can be modified by clicking on the square next to the word 'Colour'. There are a range of pre-defined colours but custom colours can also be created.

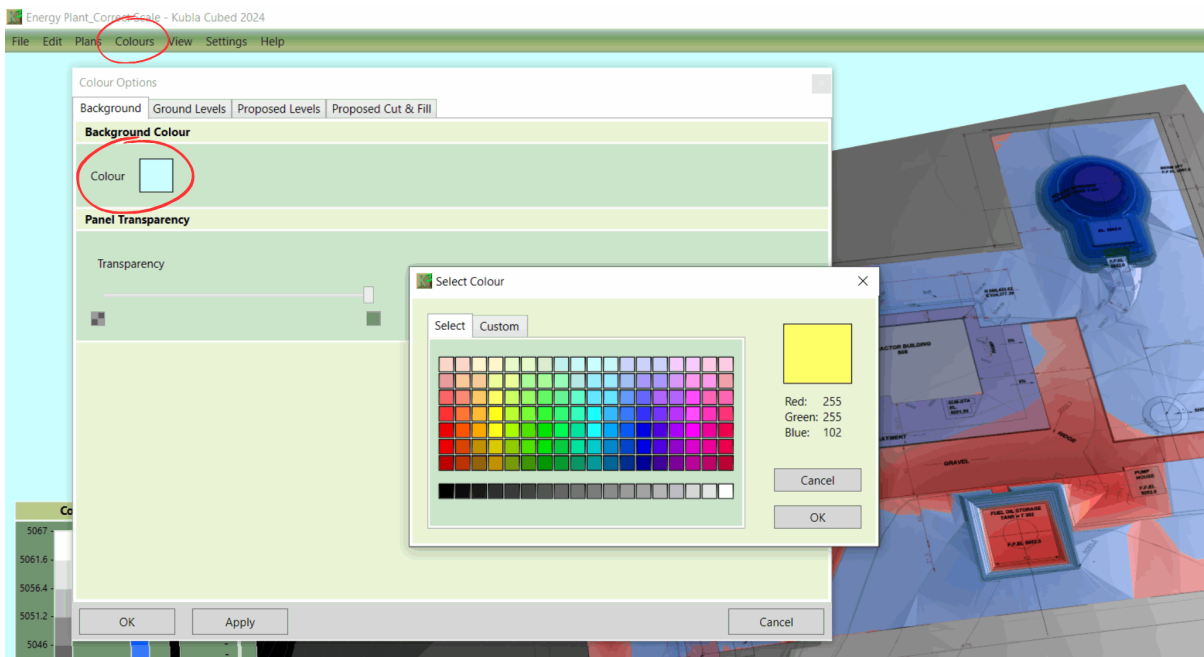

Moving the horizontal slider within the 'Panel Transparency' section furthest to the right, will make the entire interface completely opaque. Likewise, sliding fully left will render everything but text and essential interface options, fully transparent.



See application settings in our quick tip video [Kubla Cubed Quick Tip | Changing Background Panel Colour](#).



## Cursor Label

As the mouse cursor is moved around your project, a label can be displayed in real-time, containing data about the position underneath. The label can include the element name, X and Y co-ordinates, existing/proposed elevations, and cut/fill values. The label options can be customised to show only the information you require.

In the project's design area, the label reveals information about the point on the surface underneath the cursor. Using the settings menu, you can customise the displayed information, including the X,Y co-ordinates, existing/ground level (Z: (Ground)), proposed level (Z: (Proposed)) and the Cut and Fill. For example, the image below displays: **Element Name**, X:324,105.64ftE, Y:680,435,30ftN, Z: 5046.90ft (Ground), Z: 5050ft (Proposed), Fill: 3.10ft.

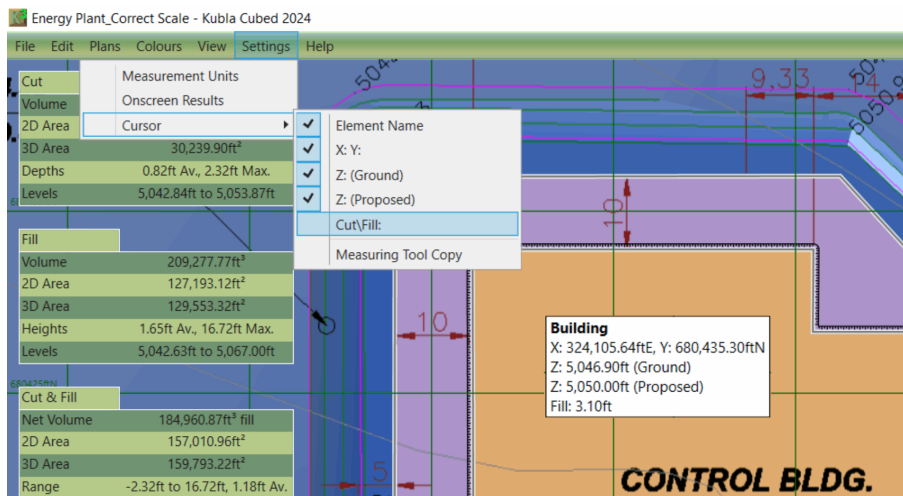

To access the cursor options, click on the 'Settings' menu bar and then select 'Cursor'. Here, the available items that can be displayed in the cursor label can be turned on/off (shown in the image above).

**Notes on Copying the Label Contents :** Sometimes, there is a requirement to copy the contents of the cursor label. While you can manually copy it down, this can be time-consuming and lead to mistakes. To copy the contents of the cursor label to the clipboard, ensure that the 'Measure Tool Copy' is ticked in the cursor menu. Then, simply tap the 'M' key. This will activate the quick measure tool and copy the contents to the clipboard. After copying, go to a document/spreadsheet and paste using either the 'Edit' menu of the program or the universal 'Ctrl+V' shortcut for pasting. For more information see [Quick Measure Tool](#) .



See application settings in our quick tip video [Kubla Cubed Quick Tip | Change the Cursor Label](#) .



## Navigation

Navigation is done either using the mouse, the keyboard, or the buttons on the navigation panel. The way the navigation works depends upon the camera you have selected for display.





You can choose whether you want to navigate through each phase independently or sync navigation between phases. The best option can depend on the situation. If each phase is focused on different parts of the site, it may be easier to navigate independently. Conversely, if each phase is building up parts of the same area it can be easier to sync the navigation. To toggle this setting, you can click on View and then Single Camera Mode.

There are **three different cameras** that you can use to display and navigate in Kubla Cubed, as described below.

When you change the cameras, the controls for navigation will also change.

	<p><b>Design View</b></p> <p>This option displays the project in plan view (2D) from above. You must be in this view to draw lines to create all design elements except for the surface.</p>
	<p><b>3d Orbit View</b></p> <p>This 3d view is used to orbit around the centre of the terrain, as well as to tilt the view up and down.</p>
	<p><b>3d Flyover View</b></p> <p>This 3d view is used to fly over the existing terrain and allows the user to move forward and backward and rotate the view in all directions.</p>



The following controls are the same regardless of the camera you have selected.



	<p><b>Zoom In</b></p> <p>Keyboard: '+' key</p> <p>Mouse: <i>Scroll Wheel Forwards</i></p>
	<p><b>Zoom Out</b></p> <p>Keyboard: '-' key</p> <p>Mouse: <i>Scroll Wheel Backwards</i></p>
	<p><b>Zoom to Extents</b></p> <p>This button zooms to frame all visible items.</p>
	<p><b>Zoom to Selection</b></p> <p>This button zooms to frame the selected element.</p>

The rest of navigation controls depend upon the camera you have selected.

### Navigation in 2D Design View





The following controls are available to navigate in design view, in addition to the general navigation controls described above.

	<p><b>Pan Right</b></p> <p>Keyboard: 'right arrow' key</p> <p>Mouse: <i>Press Scroll Wheel and Move Mouse Right</i></p>
	<p><b>Pan Left</b></p> <p>Keyboard: 'left arrow' key</p> <p>Mouse: <i>Press Scroll Wheel and Move Mouse Left</i></p>

	<p><b>Pan Up</b></p> <p>Keyboard: <i>'up arrow' key</i></p> <p>Mouse: <i>Press Scroll Wheel and Move Mouse Up</i></p>
	<p><b>Pan Down</b></p> <p>Keyboard: <i>'down arrow' key</i></p> <p>Mouse: <i>Press Scroll Wheel and Move Mouse Down</i></p>



### Navigation in 3D Orbit View





The following controls are available to navigate in orbit view, in addition to the general navigation controls described above.

	<p><b>Orbit Right</b></p> <p>Keyboard: <i>'right arrow' key</i></p> <p>Mouse: <i>Press Scroll Wheel and Move Mouse Right</i></p>
	<p><b>Orbit Left</b></p> <p>Keyboard: <i>'left arrow' key</i></p> <p>Mouse: <i>Press Scroll Wheel and Move Mouse Left</i></p>
	<p><b>Orbit Up</b></p> <p>Keyboard: <i>'up arrow' key</i></p> <p>Mouse: <i>Press Scroll Wheel and Move Mouse Up</i></p>
	<p><b>Orbit Down</b></p> <p>Keyboard: <i>'down arrow' key</i></p> <p>Mouse: <i>Press Scroll Wheel and Move Mouse Down</i></p>

### Navigation in 3D Flyover View

The following controls are available to navigate in flyover view, in addition to the general navigation controls described above.

	<p><b>Move Right</b></p> <p>Keyboard: <i>'right arrow' key</i></p> <p>Mouse: <i>Press Scroll Wheel and Move Mouse Right</i></p>
	<p><b>Move Left</b></p> <p>Keyboard: <i>'left arrow' key</i></p> <p>Mouse: <i>Press Scroll Wheel and Move Mouse Left</i></p>
	<p><b>Move Forward</b></p> <p>Keyboard: <i>'up arrow' key</i></p>

	Mouse: <i>Press Scroll Wheel and Move Mouse Up</i>
	<b>Move Back</b> Keyboard: 'down arrow' key Mouse: <i>Press Scroll Wheel and Move Mouse Down</i>
	<b>Look Right</b> Mouse: <i>Press Left and Right Buttons and Move Mouse Right</i>
	<b>Look Left</b> Mouse: <i>Press Left and Right Buttons and Move Mouse Left</i>
	<b>Look Up</b> Mouse: <i>Press Left and Right Buttons and Move Mouse Up</i>
	<b>Look Down</b> Mouse: <i>Press Left and Right Buttons and Move Mouse Down</i>



All cameras are described in [Getting Started - Navigation](#). Use the following links to access the camera of interest.

- [Design View Camera](#)
- [3D View Camera](#)
- [3D Flyover Camera](#)

## Undoing and Redoing Changes

Each successive change to a project may be undone or redone by selecting the Undo and Redo options in the Edit menu.

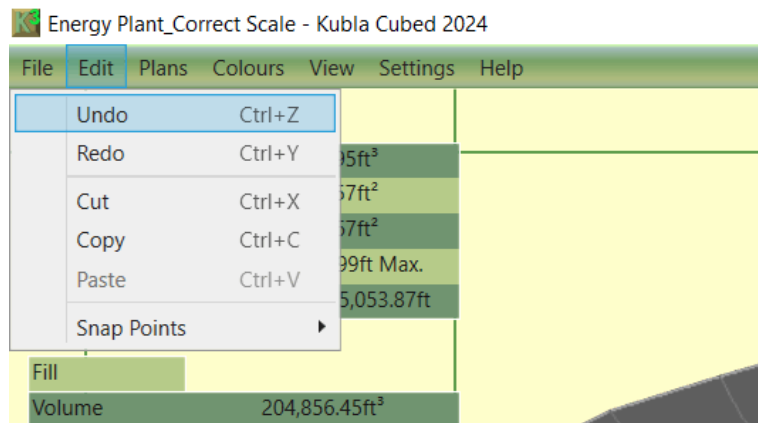

Alternatively, undo and redo via the shortcut keystrokes: Ctrl+Z for undo and Ctrl+Y for redo. The resulting changes will display in the 2D and 3D views.

## Selecting Elements

Select Disturbance Areas

The selection highlights in 2D or 3D to identify the elements within a selection. It draws attention to the element's location on both the panel and the model, which is not always clear in larger projects.

- Left-click to select an element and turn flashing on.
  - Select by clicking on the listed element in the elevations panel.
  - Select by clicking on the 2D or 3D surface.
  - Hold down Ctrl and left-click to select multiple elements.
  - Group select by holding down the *shift* key whilst clicking on the first then last item.
- Right click to turn flashing off.

## Loading and Saving Files

---

Loading and saving strategies are essential as a project develops to recover from mistakes and application crashes. These include manual saving, loading, and auto-recovery.

### Loading Projects

#### New Project

Create a new project either by opening Kubla Cubed, or if the software is open, go to the menu option File → New Project.

#### Open Existing Project

Projects can be loaded through the menu option: File → Open Project, which initiates a file selection window. Alternatively, for a swifter approach, you can select a project from the list of recently loaded projects via the menu option File → Recent Projects.

### Saving Projects

Once a project has been created or amended, it needs to be saved. It is recommended to save multiple versions of projects frequently so that previous versions can be restored if mistakes are made. Projects can be saved manually via the menu options File→Save Project, which will overwrite the original project, or with a different project name via the menu option File→Save Project As

Additionally, an auto-recoverable backup copy of manually saved projects will be automatically created and kept until older files are deleted (see auto-recovery sweeps). These auto-recovery backups can then be restored later.

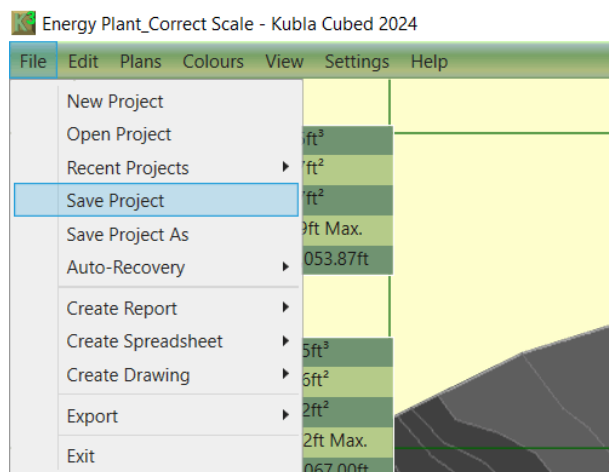

The image displays file dropdown options, including "Open Project," "Recent Projects," "Save Project/As," and "Auto-Recovery".

## Auto-Recovery

### Auto-Recovery

Your manual save location, stores the most recent version of your project. However, auto-recovery preserves previous versions (older manual saves) in addition to auto-saves.

### Auto-Recovery Settings

This feature can be switched on via the menu option:

File→ Auto-Recovery→ Options

where a list of backup intervals is available, ranging from one to 30 minutes.

**Note:** The automatic backup interval is timed *from the last project amendment* to prevent excessive saving when no changes have been made.

Auto-Recovery can be switched off using the menu option File→ Auto-Recovery→ Options→ Off. This option is **not recommended**, unless disk space is limited.

The ‘Off’ option will not create auto-recovery backup versions, so only manually saved projects will be available for loading via the File menu options Open Project or Recent Projects. To save different versions with auto-save set to off, the project name will have to be changed manually on every save.

If the backup becomes obtrusive, the recommended alternative method for turning off auto-save is to use the menu option File→ Auto-Recovery→ Options→ Only On Manual Save.

This will save an auto-recovery version in addition to projects saved manually (via the menu options File→ Save Project or ‘Save Project As’) and can then be later restored via auto-recovery loading.

### Recovering Projects

There are two methods for recovering previous versions of files saved manually or via auto-save:

1. via the Auto-Recovery Restore Window, shown on opening Kubla Cubed.
2. via the menu option File → Auto-Recovery → Recover.

### Restoring Projects After Application Crash

In the event of an application crash and the project was saved beforehand, the Auto-Recovery Restore window will be automatically displayed when the application is restarted. This window lists all previously saved versions of the last saved project that was being amended when the application crashed, along with options to restore one of them. To restore the latest or an older project version, press the “Restore” button alongside the corresponding project name and the time it was last saved.

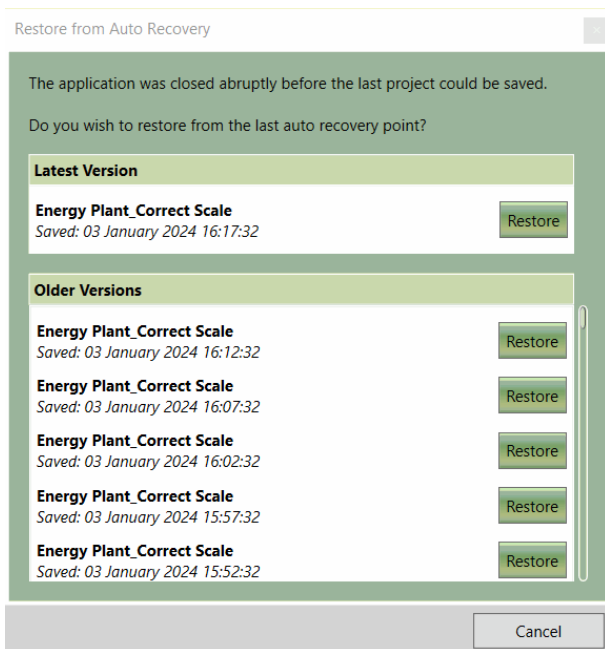

The 'Restore from Auto Recovery' window displays after restarting the application following a crash. It shows the latest and previous versions of projects that can be restored.

## Restoring Previous Project Versions

Previously saved versions of a project may be restored manually by choosing the project via the menu option File → Auto-Recovery → Recover, which lists all recently saved project versions along with their saved times.

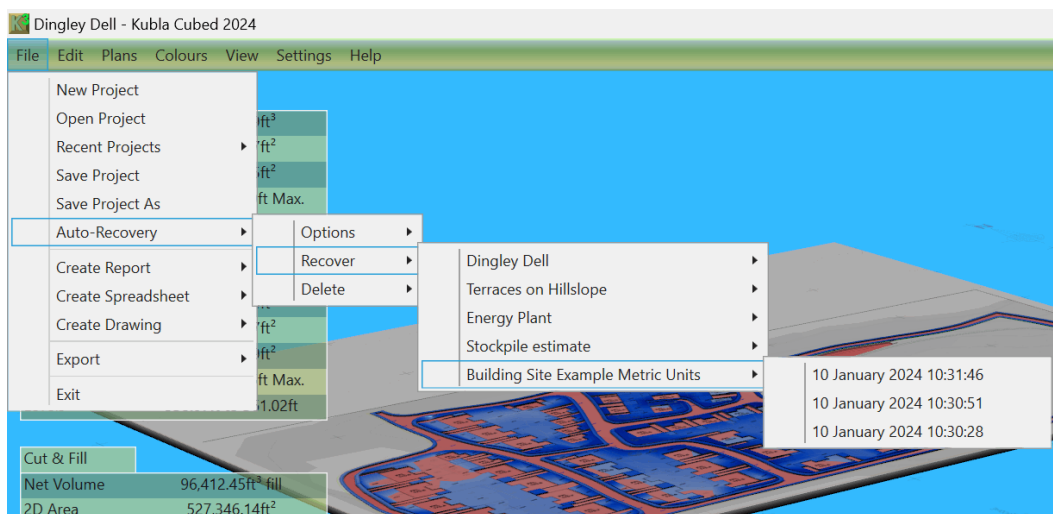

Auto-Recovery menu, displaying available auto-saved version history options for project recovery.

## Deleting Auto-Recovery Versions

Deleting an auto-recovery version will prevent that version from being restored and is not recommended unless disk space limited, a project is no longer needed, or needs removing for confidentiality reasons. The preferred method is to allow the auto-recovery sweep to automatically delete older project versions as newer versions are saved.

Auto-recovery versions of a project may be deleted manually by choosing the project via the menu option

File → Auto-Recovery → Delete, which lists all recently saved project versions along with their saved times and appears similar to the Auto-Recovery → Recover option.

### Auto-Recovery Sweeps

To free up disk space, an auto-recovery sweep will automatically be performed to delete older project versions as newer versions are saved.

All auto-recovery saves for each project within the hour are kept, along with hourly projects within the day, daily within the week, weekly within the month, monthly within 6 months and quarterly within the year. Any auto-recovery saves older than a year are deleted.

Although you will have your auto-recovery files, we still recommend you save your own versions of your project to avoid any loss of work.

## Keyboard Shortcuts / Hotkeys

---

Shortcuts enhance the users experience of *Kubla Cubed*, increasing efficiency by minimising the time it takes to perform tasks, while providing flexibility when working on projects.

Function	Shortcut Keys
Undo	Ctrl + Z
Redo	Ctrl + Y
Cut	Ctrl + X
Copy	Ctrl + C
Paste	Ctrl + V
Presentation Mode	Ctrl + F
Measure a length.	M ( <i>hold and move cursor along length</i> )
Add a point to a section of a drawn line.	Z ( <i>select line section and tap</i> )
While drawing a line, remove the previous point.	Backspace ←
Escape from an operation or Exit Presentation Mode.	Esc
Zoom to extents.	Home



---

# Chapter

# 3

---

## Display

---

### Topics:

- [Display Panel](#)
- [Element Shading](#)
- [On-Screen Statistics](#)
- [Single Camera Mode](#)
- [Presentation Mode](#)
- [Colour Keys](#)
- [Vertical Exaggeration](#)







You have the flexibility to customise the display of your project in several ways, such as choosing the camera type, selecting surface shading preferences, and toggling the display of incline lines for side batter slopes.

## Display Panel

You can customise the display of your project in a number of ways, such as selecting the camera type, defining the surface shading, and deciding whether to display incline lines for the batter slopes.



Within the Display panel, you will find the controls which are used to adjust the display for the current phase.

It is important to note that lines are not currently displayed in either of the 3D views. Consequently, all controls related to the display of lines will be disabled when either of the 3D cameras are selected.

	<p><b>Camera Selector</b></p> <p>This dropdown allows you to choose the camera used to display the project. It is used to determine whether you are displaying in 2D or 3D modes. For more information, see <a href="#">Cameras</a>.</p>
	<p><b>Lighting Mode</b></p> <p>This dropdown allows you to choose the lighting used to display the project. Options include Hard Lighting, Soft Lighting, and No Lighting. <a href="#">Lighting</a> on page 22</p>
	<p><b>Earthworks Shading Mode</b> <i>(Not in Existing Tab)</i> <a href="#">Element Shading</a> on page 24</p> <p>This dropdown allows you to choose the method used to shade the proposed earthworks. Options include Earthworks Cut &amp; Fill, Earthworks Levels, Match Ground, and Element Colours.</p>
	<p><b>Line Visibility</b> <i>(Not in Existing Tab)</i></p> <p>This dropdown allows you to choose the lines displayed for the proposed earthworks. Options include Incline Lines, Outlines Only, and No Lines. <a href="#">Line Work</a> on page 23</p>
	<p><b>Site Plan Visibility</b></p> <p>This button allows you to display site plans in different views. Options include All Views, 2D Views, 3D Views, and No Site Plans. <a href="#">Site Plan Visibility</a> on page 23</p>
	<p><b>Toggle Selection Lines</b> <i>(Not in Existing Tab)</i></p> <p>This button allows you to choose the turn the selection lines for the earthworks elements on and off.</p>
	<p><b>Toggle Grid Lines</b></p> <p>This button allows you to turn the grid lines on and off.</p>

## Lighting



There are three different lighting options that can be used to display the existing and proposed terrain, as described below.

	<p><b>Hard Lighting</b></p> <p>This option will light the terrain with hard edges. This lighting mode gives a clear representation of variations in slopes throughout the terrain and is particularly useful for validating defined levels.</p>
	<p><b>Soft Lighting</b></p> <p>This option will light the terrain with smoothed edges. This can give a visually attractive representation of the terrain. However, it can also smooth hard edges in the terrain which can provide an unrealistic representation of the ground levels.</p>

	<p><b>No Lighting</b></p> <p>This option turns off all lighting. This option is useful for clear representations (particularly in 2D) which show the difference in levels by colour and where the variation in slope does not need to be visualised.</p>
---	--





## Line Work

There are three options for the display of earthworks lines as described below.

	<p><b>Incline Lines</b></p> <p>This option will display the outlines of the earthworks, as well as lines indicating the direction of the batter slope.</p>
	<p><b>Outlines Only</b></p> <p>This option will display only the outlines for the earthworks.</p>
	<p><b>No Lines</b></p> <p>This option will not display any lines for the earthworks.</p>

## Earthworks Shading



There are four modes that can be used to shade the earthworks.

	<p><b>Shade Earthworks Cut / Fill</b></p> <p>This option will colour the earthworks by cut / fill depth. It is particularly useful for visualising where the cut and fill will be highest in the project area.</p>
	<p><b>Shade Earthworks Levels</b></p> <p>This option will colour the earthworks by level with a totally independent colour scheme to that used by the existing terrain. This is useful when you need to show the earthworks levels, but you want to make a clear distinction from the existing ground.</p>
	<p><b>Match Ground Shading</b></p> <p>This option will colour the earthworks exactly the same as the existing ground so that it appears as a single surface. This mode is useful for quickly visualising what the final terrain will look like once the earthworks are completed.</p>
	<p><b>Element Colours</b></p> <p>This option will colour the earthworks to an automated colour selection (or a colour of your choice), to show the extent of the reporting area for each element type (building pad, garage, soft landscaping etc.) that is in a project. This is useful to quickly locate a particular group of elements (e.g. all building pads).</p>

## Site Plan Visibility

There are four options for the display of site plans as described below.

	<p><b>Site Plans in All Views</b></p> <p>This option will display site plans in all model views (2D and 3D).</p>
---	--

 <p><b>2D</b></p>	<p><b>Site Plans in 2D Views</b></p> <p>This option will display site plans in the 2D model view only.</p>
 <p><b>3D</b></p>	<p><b>Site Plans in 3D Views</b></p> <p>This option will not display site plans in the 3D model view only.</p>
 <p><b>OFF</b></p>	<p><b>No Site Plans</b></p> <p>This option will not display any site plans.</p>

## Element Shading

In a proposed phase, you can choose between four different ways to shade the surface. To change to different shading modes, click the [Shading](#) dropdown in the Display Panel.

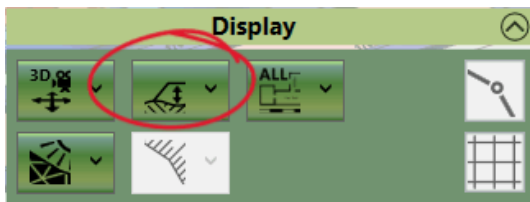

The four shading modes and their differing impacts on the way the surface is coloured are shown below:

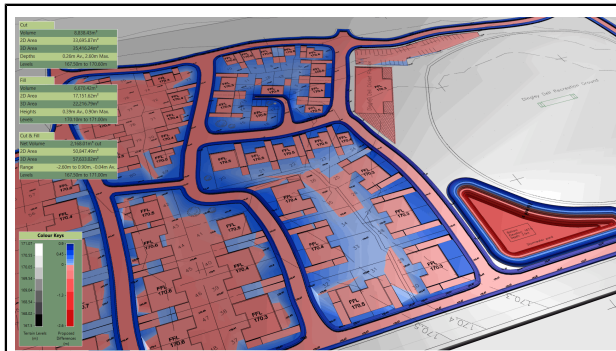

**Shade Earthworks Cut/Fill**

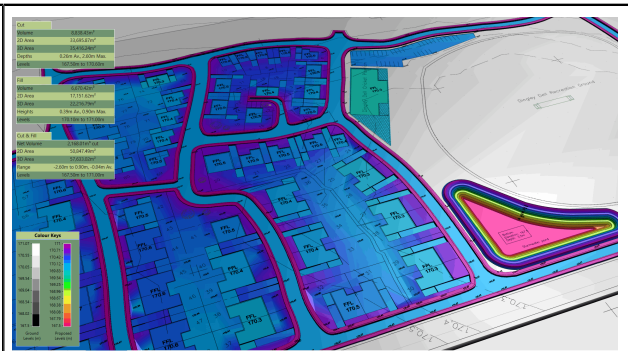

**Shade Earthworks Levels**

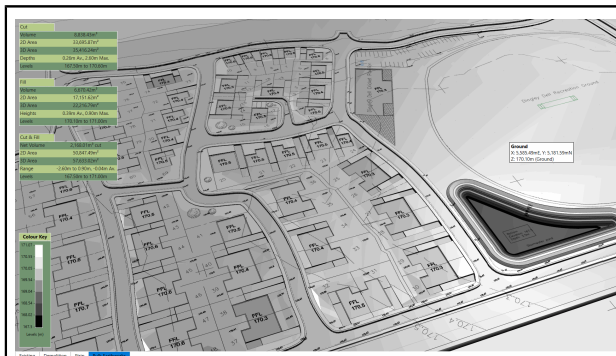

**Match Ground Shading**

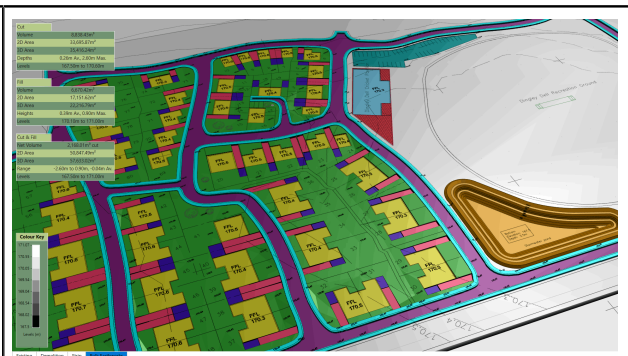

**Element Colours**

- **Shade Earthworks Cut/Fill:** This mode shades the proposed earthworks based on cut depths and fill heights. It is the default shading mode, and unless you customise the colour key, it shades the proposed surface red in cut areas and blue in fill areas. Deeper cut sections are coloured a darker red, and higher fill areas a deeper blue. You can customise the [‘Proposed Cut & Fill’ colour key](#).
- **Shade Earthworks Levels:** This mode shades the proposed earthworks by elevation. It is a common shading technique used in cartography and can help identify high and low points in your proposed design, providing a greater understanding of elevation changes across your surface. Customise colours at different elevation bands by editing the [‘Proposed Levels’ colour key](#).
- **Match Ground Shading:** Selecting ‘Match Ground Shading’ matches the shading of the proposed surface to that used by the ground surface. The ground surface is shaded by elevation in the same way as the ‘Shade Earthworks Levels’ option, with the only difference being that the ground surface and proposed surface share the same colour key. Customise colours at different elevations by editing the [‘Ground Levels’ colour key](#).
- **Element Colours:** In this mode, different elements are shaded in a variety of colours. This simple shading scheme is useful for understanding element overriding. Elements that intersect can override each other. Absolute elements always override higher elements, and relative elements override higher relative elements (with default settings). Shading by element colours helps visualise which element is overriding others in these scenarios. The coloured area of each element corresponds to the reporting areas used in the element breakdown in the estimation spreadsheet/report.

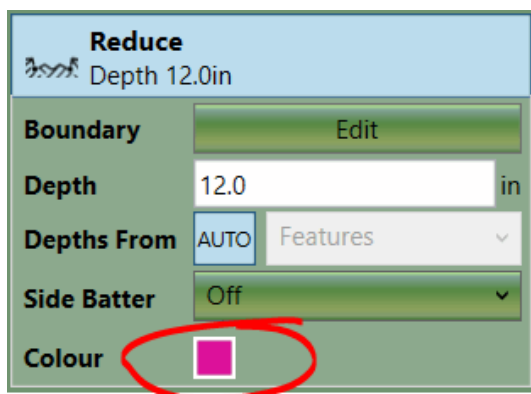

Elements are automatically assigned a colour on creation, but you can modify the colour of an element by double-clicking on the colour swatch (the ‘Colour’ option only appears when in Element Colours mode).

## On-Screen Statistics

---

The Cut, Fill and Cut & Fill summaries for the selected phase are displayed in the top left corner. These are hidden while editing elements. Options determining the level of detail are set within the Project Settings, which are found in the top menu under Settings → Onscreen Results.

In the image below, all options have been ticked/enabled.

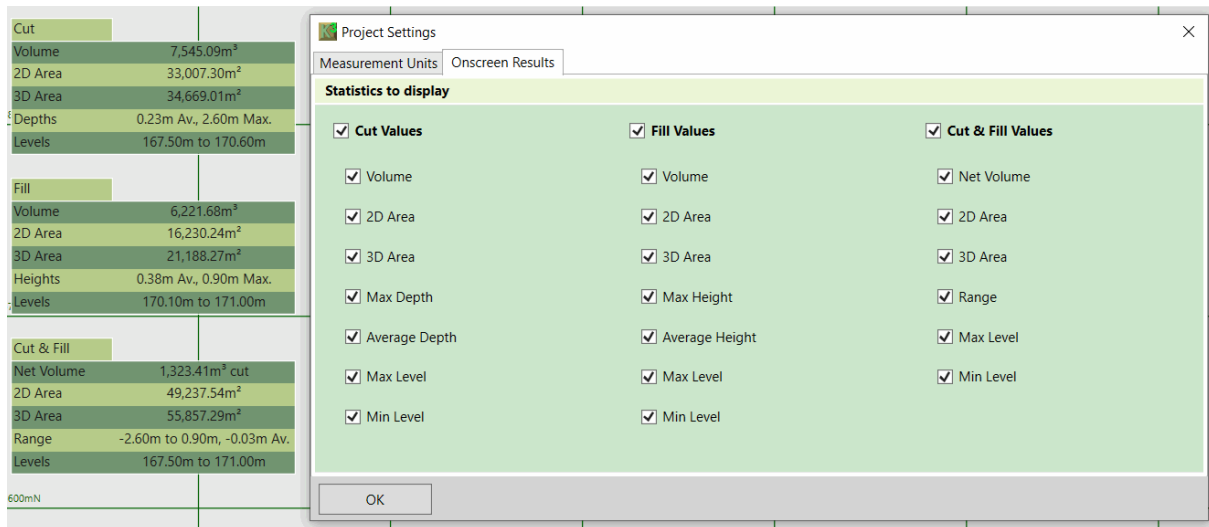

## Single Camera Mode

Each phase can have a separate camera assigned, but these can be synchronised. The decision on whether to navigate through each phase with its own camera or to sync navigation between phases depends on the situation. If each phase is focused on different parts of the site, it may be easier to navigate independently. However, if each phase is building up parts of the same area, synchronising the navigation can be more efficient.

When Single Camera Mode is set, all phases will begin using the same camera as used on the current phase. To toggle this setting, in the menu, select View → Single Camera Mode.

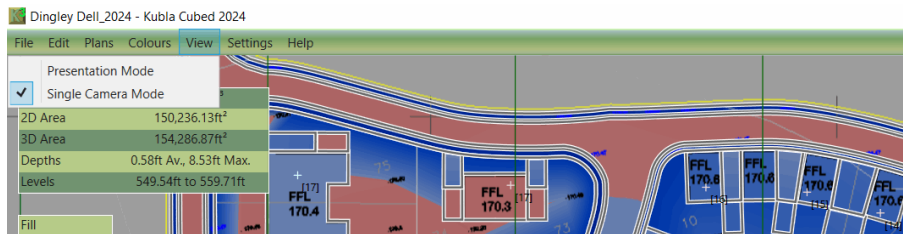

## Presentation Mode

*Kubla Cubed* features a presentation mode for showcasing the software in presentations. This mode removes all the editing controls as well as the title bar, providing a full-screen view of the relevant project content. To enter presentation mode, click on the View menu and then Presentation Mode. Alternatively, press Ctrl and F together (CTRL+F). Press Escape (Esc) to exit.

## Colour Keys

The shading schemes used to display the terrain and earthworks are customisable by the user. *Kubla Cubed* comes with a number of pre-set colour tables with options for user customisation, such as choosing between discrete and beled shading.

Additionally, users have the capability to generate their own colour tables for fully customised output.

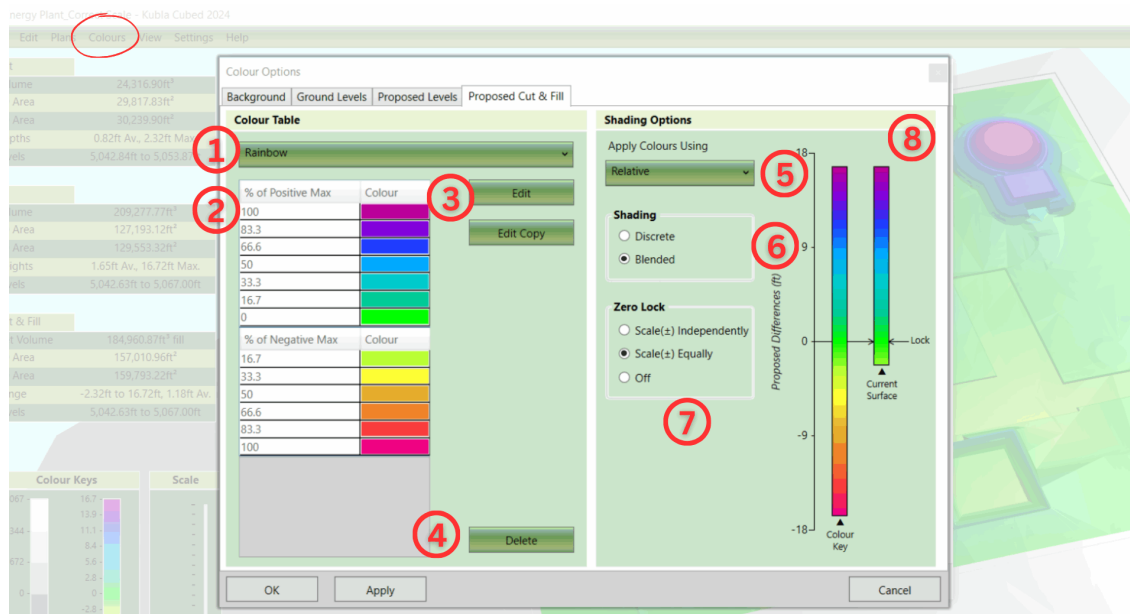

The shading schemes used to display the terrain and earthworks can be fully customised. The 'Colours' menu provides options for editing the shading schemes for 'Ground Levels', 'Proposed Levels', and 'Proposed Cut & Fill'. Each earthworks display mode uses different shading schemes:

- Match Ground Shading - Ground Levels.
- Shade Earthworks Levels - Ground Levels and Earthworks Levels.
- Shade Earthworks Cut & Fill - Ground Levels and Earthworks Cut & Fill.
- Colour Elements - Defines each element with its own colour to show overriding elements. Colours can be edited in Elevations panel. See [Element Shading](#).

A shading scheme consists of a table of colours with corresponding values (2). There is a library of these colour tables to choose from, and a shading scheme's colour table can be changed by selecting a different one from a drop-down box (1). You can manage the library of colour tables by deleting (4) those that are no longer needed, as well as creating and amending existing ones with the Edit or Edit Copy buttons (3).

On the right-hand side of a shading scheme tab, there are options for controlling the way the colour table is applied to a surface (i.e. the existing ground or earthworks). When you select different options, the diagram (8) updates to display where on the surface the colours will be applied.

Apply Colours Using (5) - This is where the method for applying the colour table to the surface is chosen. The two methods are:

- Relative: A shading scheme using the relative shading will scale the scheme to fully cover the surface being shaded. For this reason, in relative mode, colour table values show as percentages. This method ensures that the surface uses the full range of colours in the table, adapting as the design changes.
- Absolute: The absolute method applies colours using the exact values in the table, providing total control over where the colours are applied on the surface. However, it does not adapt when new terrain is loaded or earthworks changes, so it may need to be manually adjusted when there are significant alterations to a project.

Shading (6) - There are two different shading options: Discrete and Blended. With Discrete shading, colours are not blended, resulting in discrete blocks of the same colour. When Blended is selected, the surface is shaded by smoothly interpolating between the colours in the colour table. See the image below for an illustration of the difference between these two shading modes.



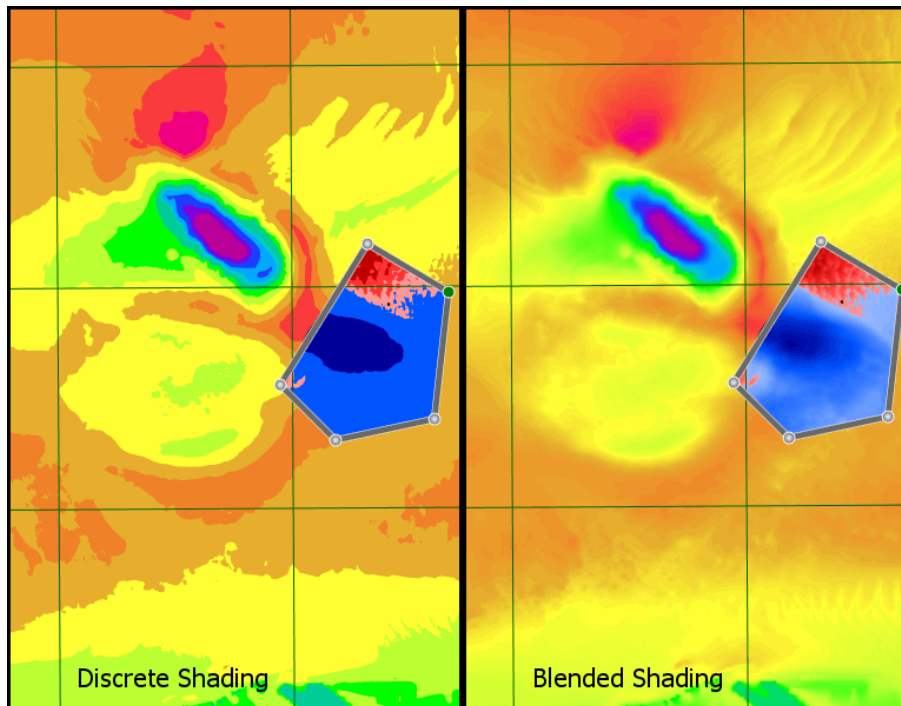

A consequence of using an absolute scheme with discrete shading is that the last colour in the table will not be used. This is because the first two values are used for the range of the first colour, the second and third for the next, and so on, resulting in the last colour being redundant. In relative mode, the values are adjusted to make use of all the colours in the table.

**Zero Lock ⑦** - When shading a surface, it's often necessary to lock a particular colour to zero. For example, when shading terrain, you might want a colour locked at zero to indicate the difference between land and sea, or to show the areas on a platform in different colours for cut and fill (in difference shading mode). With absolute shading schemes, this is simply a matter of setting a colour value to zero. However, with relative shading, it is a little more complex, as the 'zero' value moves as it scales to fit the surface being shaded.

To resolve this, there is a zero lock feature that locks any colour with a value of zero to zero on the surface. The two different zero lock options are:

- **Scale  $\pm$  Independently:** This scales both positive and negative values independently, ensuring the colour table covers the entire surface. This is useful when aiming to display the full range of colours in the table for maximum contrast.
- **Scale  $\pm$  Equally:** This option scales values above and below zero equally. It is useful in various situations, particularly for a cut and fill shading scheme, providing a sense of depths of cut compared to fill. However, with this option, not all of the values in the table will be displayed.



Learn about the shading scheme options in our video [Adjusting Shading of Surfaces](#), featuring a demonstration on creating custom schemes.

## Vertical Exaggeration

When the model is in 3D mode, a vertical slider will appear on the bottom left corner of the screen. The purpose is to exaggerate the visualisation of elevation differences – it does not alter the values or calculations. This feature is



beneficial when checking that there are no erroneous extreme values, or to emphasise differences in the terrain when working with a relatively flat model. See [Visualisation](#) on page 137.

Dragging the slider's handle upward will increase the exaggeration. Dragging the handle downward will reduce exaggeration.

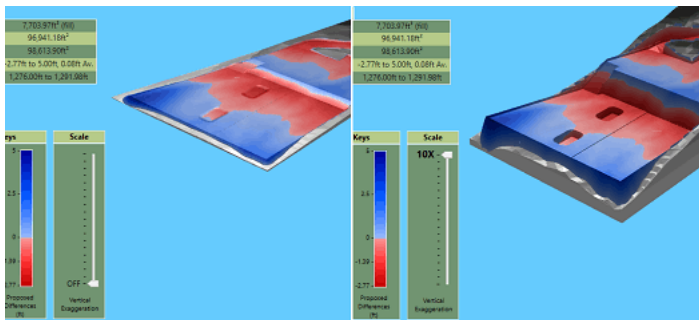

3D Orbit View camera in use; left without vertical exaggeration, right with maximum vertical exaggeration. Calculations remain unchanged as the exaggeration applies to the visualisation only.



---

# Chapter

# 4

---

## Site Plans

---

### Topics:

- [Overview](#)
- [Quick Measure Tool](#)
- [Editing Modes](#)
- [Adding a Site Plan](#)
- [Setting the Position and Cropping](#)
- [Stitching Site Plans](#)
- [Overlaying Site Plans](#)
- [Setting the Transparency](#)
- [Setting Visibility](#)

Site plans can be loaded into *Kubla Cubed* and displayed on the screen. This functionality allows the user to trace lines off the loaded plan and maintain a general awareness of the location of objects in the real world. *Kubla Cubed* supports the following file groups: PDF, CAD, and Image (e.g., .png, .jpg .gif).

## Overview

*Kubla Cubed* allows you to load site plans into your project from a number of different file formats such as .pdf, .jpg, .bmp, .tiff. You can also import a site plan from CAD (.dwg). You have the flexibility to import as many site plans as needed, switching them on and off when you need to view them.

Displaying multiple site plans simplifies the process of completing a take-off, especially when your existing and proposed elevation data are on two separate drawings. You can also use the crop, move, and align tools, allowing you to 'stitch' drawings together in situations where a single site plan is spread across separate pages of a document.

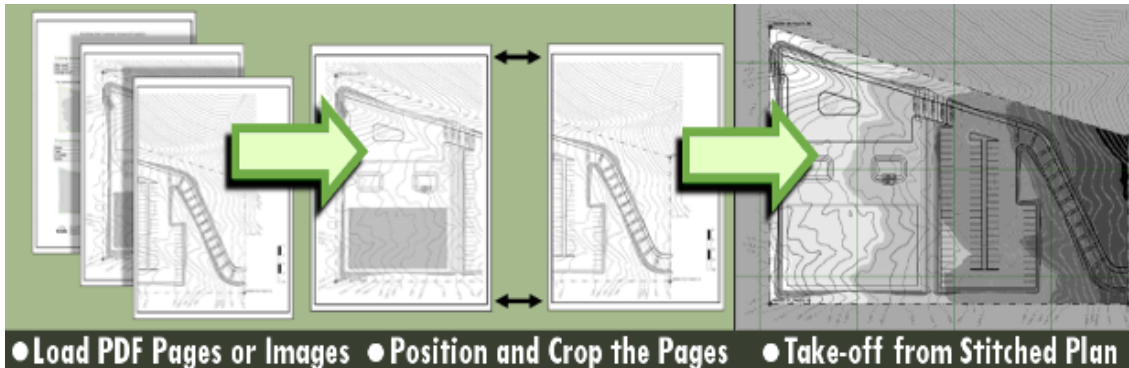

Site plans can be adjusted by clicking on the Plans menu item. The menu item will appear as shown below.

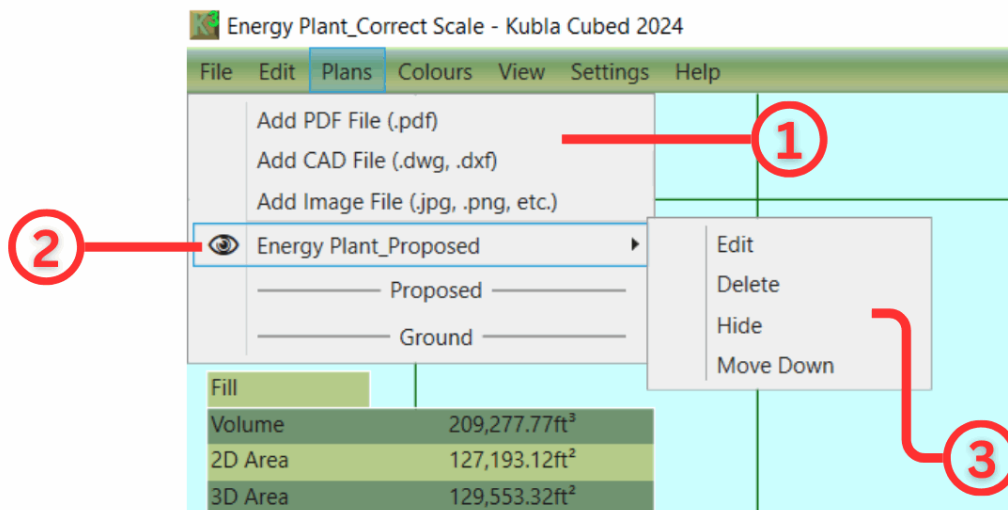

This is where your site plans are listed.

- ① Click here to add a new site plan. You can load site plans from CAD, PDFs or image file formats (.bmp, .jpg, .tiff)
- ② This is where the list of your site plans are listed. See [Setting Visibility](#) for more information.
- ③ Use this menu to Edit, Delete, Hide or Move site plans. Moving plans up/down within the list restricts visibility on proposed, ground and/or surround.

You can add as many site plans as needed, allowing you to show a site which is presented on multiple drawings, or to show both the existing and proposed, even if they are in separate drawings.



The [Site Plans - Overview](#) video quickly demonstrates options for adding, modifying, and viewing site plans.

## Quick Measure Tool

It is often necessary when creating a project to do a quick measurement of a length, especially after a site plan has been scaled or CAD data imported. Checking a known length can ensure that no mistakes have been made when scaling or selecting the units of CAD data. To activate the quick measure tool, hover the mouse over the point you want to measure from and press the M key. While keeping the M key pressed, move the mouse to the next point, and a yellow line between the two will be displayed with a cursor label showing the '2D Distance'. The measure tool can be used in the 2D Design view where project data is displayed.

### Measure Tool Copy

By default, the quick measure tool displays the 2D Distance measured in a label next to the cursor. However, you can copy details of each measurement to the clipboard if required. To do this, you need to make sure that Measure Tool Copy is ticked in the cursor menu. After completing a measurement with the M key, the details of the quick measure operation will be copied to the clipboard. After copying, go to a document or spreadsheet and paste either using the Edit menu of the program or using the universal Ctrl+V shortcut for pasting.



## Editing Modes

There are two modes of editing available in the software:

- **Pop-In Mode:** In this mode, you edit items on top of the main window. The advantage of this is that it allows you to see the items you are editing on top of other project items. It also allows you to align the new items you draw with the existing ones.
- **Pop-Out Mode:** In this mode, items are edited in a separate window, and you do not see other project items behind it. While this mode is generally used less often, it can be useful to isolate the items being edited and remove needless clutter from the screen.

The following controls are used to switch between Pop-In and Pop-Out editing modes.

	If you are using Pop-In mode, you can click this icon at the top-centre of the screen to switch to Pop-Out mode.
	If you are using Pop-Out mode, you can click this icon at the top-right of the screen to switch to Pop-In mode.

The controls available are the same regardless of the editing mode, although the layout of these controls is slightly different. The following three buttons are always present:

- OK: Clicking this button applies the changes you have made to the project and finishes editing.
- Apply: Clicking this button applies the changes you have made to the project but allows you to continue editing.
- Cancel: Clicking this button cancels the changes you have made to the project and finishes editing.

## Adding a Site Plan

Site Plans can be added from PDF, CAD, and Image. To load a new site plan, click on Plans in the menu bar and then select either Add PDF file, Add CAD file or Add Image File. You will be prompted to choose the file you want to load. If you opt for a PDF file with multiple pages, you will be prompted to select the specific page to load.

After this, the following window will be displayed:

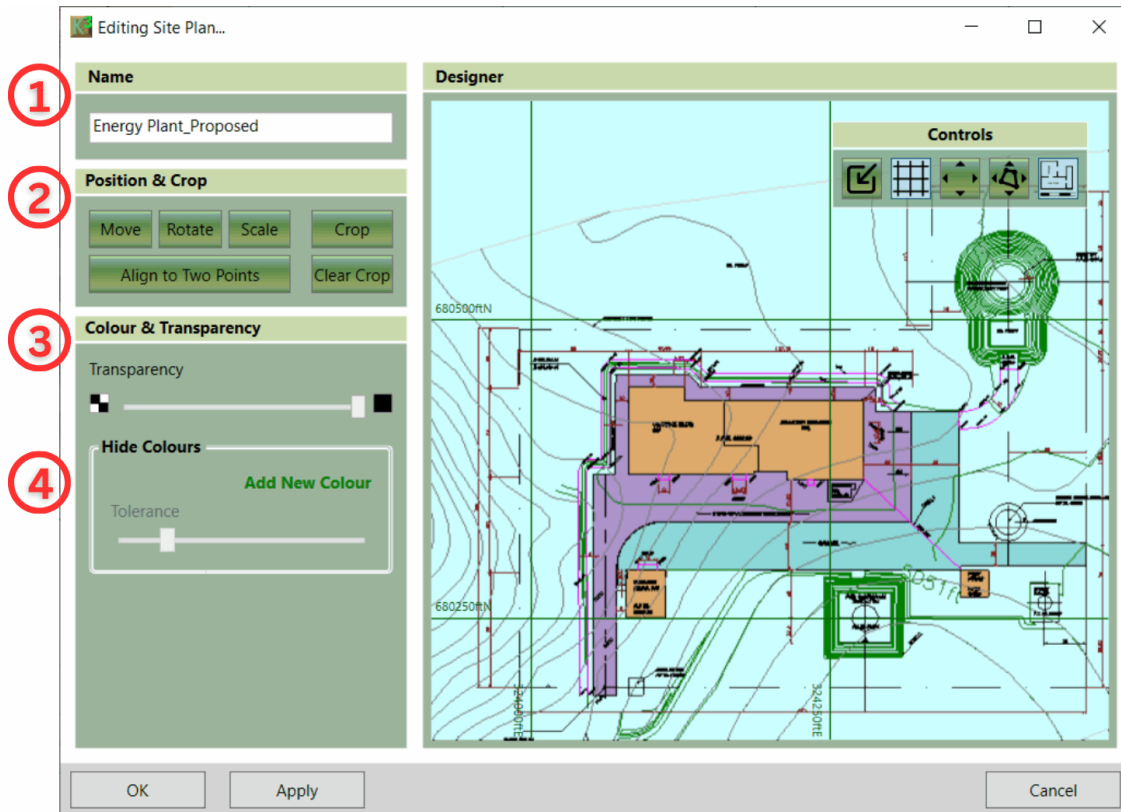

The different elements of this window are summarised below. They are described in more detail in subsequent sections.

- ① This is where you can rename the site plan. Useful for distinguishing plans, when adding multiple pages.
- ② This is where the position and scale of the loaded image, in the real world, will be specified. You can also choose to crop the image if you wish. This option is particularly useful for drawings with title blocks that you want to remove.
- ③ This is where transparency can be set, allowing the user to see the topography through the loaded site plan.
- ④ This is where you can opt to hide colours from the site plan, ensuring that the cut and fill is not obscured.

The settings for image position, crop, and the transparency are described further in the following sections.

## Setting the Position and Cropping

A site plan is positioned into its real-world location by adjusting its scale, moving its position, and rotating the image as required. Alternatively, if you have two known co-ordinates on the image, you can define them, and the software will scale, rotate and move the image to match these two co-ordinates.

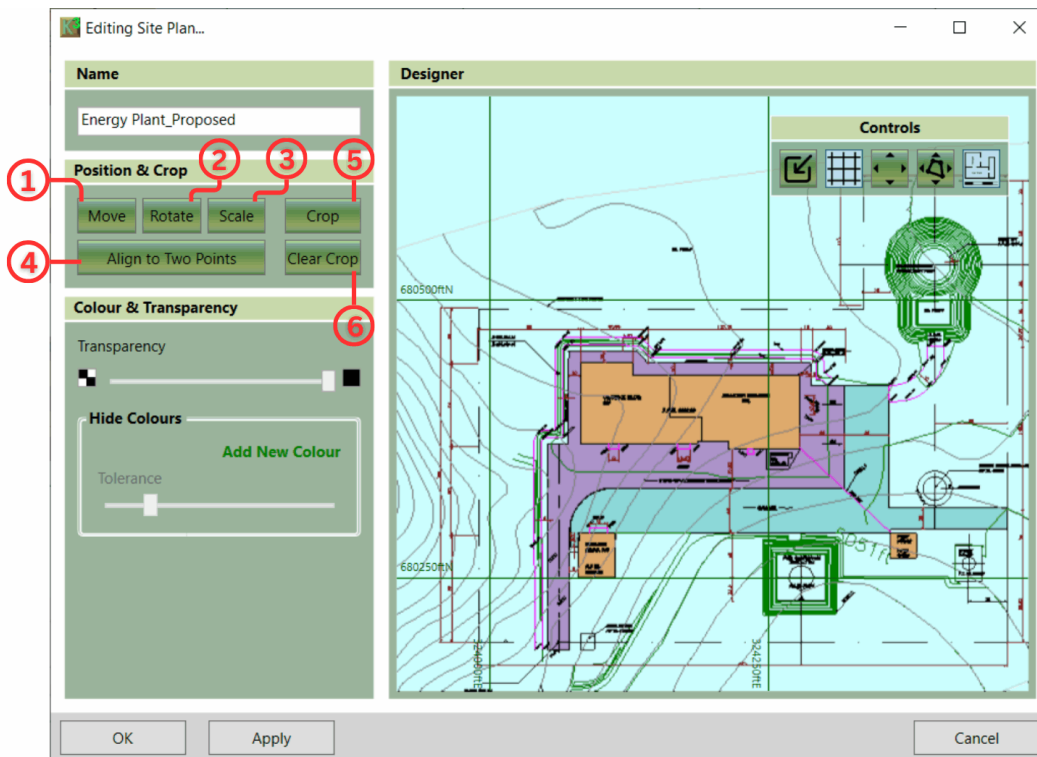

The following controls are used to define the image's position:

- ① Move: Re-position the site plan to a new point or coordinate.
- ② Rotate: Rotate the image to align to a north vertical orientation.
- ③ Scale: By Ratio or by Length.
- ④ Align to two points: Move, Rotate and Scale in one move. Align two known points to real-world coordinates.
- ⑤ Crop: Reduce the size of the site plan and remove any unnecessary information.
- ⑥ Clear Crop: Set the site plan back to the original size.



Two informative videos: [Site Plans - Scaling and Positioning](#) covers scaling techniques like 'By Length' and relative positioning. [Site Plans - Cropping](#) explains how to remove unwanted site plan imagery.

## Move

This option allows you to move the site plan image by specifying a point on the image and then entering its real-world coordinates. This is useful if there is a known co-ordinate defined on your image. It is important to remember that you should move the image after you have done any necessary scaling and rotation, as these operations will alter positions on the image.

Once you have selected this option, follow the instructions below:

### Move Prompts

#### 1. *Select a base point to move*

Define the point which you want to move by clicking once in the preview.

#### 2. *Type or click on screen to set the new position of the base point*

Type the location (X and Y) that you want this point to be moved to. Alternatively, you can click on the screen to set the new point position to another screen location.

## Rotate

This option enables you to rotate the image by defining a north reference angle on the image. This is useful if you want to display your image in an orientation different from its inherent one. For example, aligning it with a north-vertical orientation when there is a north arrow on the image that is not vertical.

Once you have selected one of this option, follow the instructions below:

### Rotate Prompt

#### 1. *Draw the north arrow (base to tip)*

Draw a line on the preview to define your reference north angle. Click once to start drawing the line and a second time to finish.

## Scale

### Scale a PDF or Image file.

You can do this with one of two methods.

Select 'Scale' then select the option you wish to use ('By Ratio' or 'By Length')

#### 1. 'By Ratio' (PDF only):

##### a. *Specify the new scale*

Type the new scale for the PDF, such as 1:100, or 1"=25'. Click OK to complete the scale.

--OR--

#### 2. 'By Length': Specify a length on the image and then type its length in the real world. This option is particularly useful if you have a defined length on your image. E.g. a scale bar or a marked dimension.

##### a. *Draw a line along a scale guide or any other known length*

Draw a line on the preview to define your reference length. Left-click once to start drawing the line and a second time to finish.

##### b. *Enter the new length*

Type the value of the length you want the reference length to be scaled to.

##### c. *Defined Scale Ratio*

The on-screen prompt will state: "The length you have defined is close to a defined scale ratio". Now choose to scale by an exact length or keep the exact length you specified.

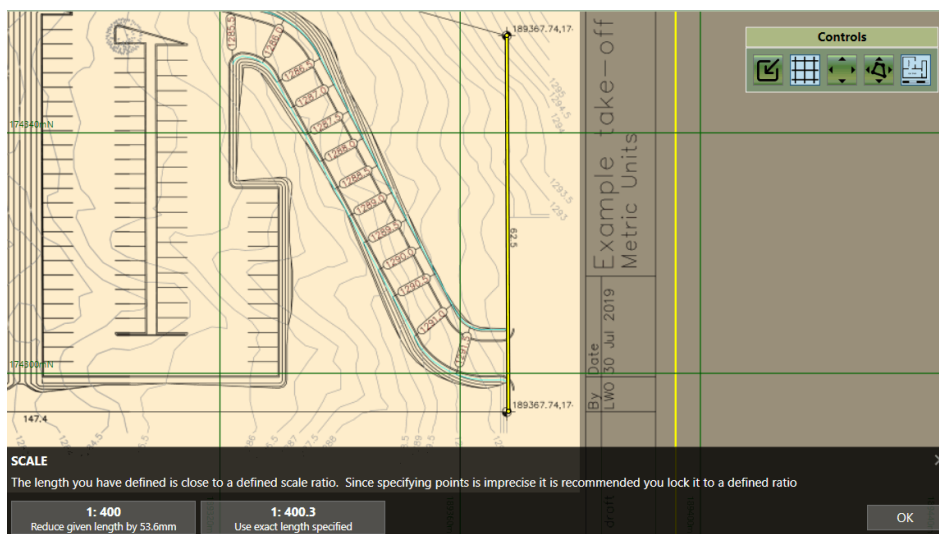



## Scaling a CAD file

CAD files are automatically imported to the scale they are created. However, there are occasions when the file imports in different units to the ones you require.

Select 'Scale' and then choose the unit you want to scale the site plan in.

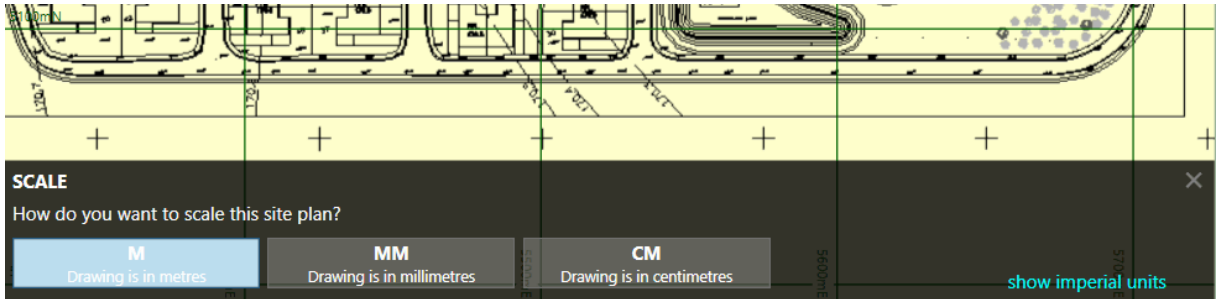

## Align to Two Points

This is the easiest option if you have two co-ordinates defined in the image. It allows you to specify the two points on the image and then type their co-ordinates in the real world. The software will then scale, move and rotate as required to match these two points.

### Align to Two Points Prompts

#### 1. *Select the first point to align*

Define the position of the first reference point by clicking once in the preview.

#### 2. *Type or click on screen to set the new position of the first point*

Type the location (X and Y) that you want the first point to be moved to. Alternatively you can click on the screen to set the new position to another screen location.

#### 3. *Select the second point to align*

Define the position of the second reference point by clicking once in the preview.

#### 4. *Type or click on screen to set the new position of the second point*

Type the location (X and Y) that you want the second point to be moved to. Alternatively you can click on the screen to set the new position to another screen location.

Once you have completed the instructions on the prompts, the prompt will disappear and the image will be adjusted as you have specified.

## Crop

You can crop the site plan to remove any unnecessary borders and titles. This is done by clicking on the Crop ⑤ button. You will be prompted to draw the crop rectangle on the screen. You can clear this crop by clicking on Clear Crop ⑥ button, and you can always adjust it by clicking again on the Crop ⑤ button in the [editing site plans window](#).

## Stitching Site Plans

When stitching multiple plans within a single project, it's crucial to ensure alignment across all plans.

Here's a step-by-step guide to complete the process:

### 1. **Scaling the First Plan:**

Before stitching additional plans, ensure that the initial plan is appropriately scaled. This sets the foundation for accurate alignment.

### 2. **Verifying Scale Compatibility:**

When incorporating a second plan, double-check its scale to match the first plan (Hold down the M key and move the cursor along a known length). Consistency in scale is vital for seamless integration.

### 3. Orientation Alignment:

If the site plans share the same orientation, using the 'Move' control suffices for alignment. For varying orientations, the 'Align to Two Points' feature may be more suitable, albeit requiring a few additional steps.

The selection between 'Move' and 'Align to Two Points' depends on the specific requirements of your project.

### 4. Move:

Procedure

- Activate the [Move](#) on page 35 tool.
- Click on the initial location on the site plan you want to move. This is likely to be a 'Match Line'.
- Do a second click on the desired destination site plan ('Match Line') where you want to plan to move to.

### 5. Align to Two Points:

Procedure:

- Select the [Align to Two Points](#) on page 37 tool.
- Click on the initial location on the site plan you want to move. This is likely to be the one end of a 'Match Line'.
- Do a second click on the desired destination site plan (the end of a 'Match Line') where you want to plans to line up.
- Repeat the process for a second location (the other end of a 'Match Line'), optimising alignment.

## Overlaying Site Plans

---

When overlaying multiple PDF/Image plans within a single project, it's crucial to ensure alignment across all plans.

Here's a step-by-step guide to complete the process:

### 1. Scaling the First Plan:

Before adding and overlaying multiple plans, ensure that the initial plan (existing terrain) is appropriately scaled. This sets the foundation for accurate alignment.

### 2. Verifying Scale Compatibility:

When you add a second plan, double-check its scale matches the first plan (Hold down the M key and move the cursor along a known length). Consistency in scale is vital for seamless integration. If the scales differ, you will need to scale each plan independently.

### 3. Orientation Alignment:

If the site plans share the same orientation, using the 'Move' control suffices for alignment. For varying orientations, the 'Align to Two Points' feature may be more suitable, albeit requiring a few additional steps.

The selection between 'Move' and 'Align to Two Points' depends on the specific requirements of your project.

### 4. Move:

Procedure:

- Activate the [Move](#) on page 35 tool. Go to Plans → Edit next to the site plan you want to move.
- Click on the initial location on the site plan are moving.
- Do a second click on the desired destination site plan where you want to plan to move to.

### 5. Align to Two Points:

Procedure:

- Select the [Align to Two Points](#) on page 37 tool. Go to Plans → Edit next to the site plan you want to move.
- Click on the initial location on the site plan you want to move.
- Do a second click on the desired destination site plan where you want to plan to move to.
- Repeat the process for a second location, optimising alignment.

### What if I need to overlay CAD and PDF site plans?

In this scenario, you should import the CAD site plan first. This is because the CAD plan will be scaled and positioned so you can then use the Move and Align to Two Points tools to position the PDF to over the CAD plan.



Learn about moving and aligning site plans in our videos [Move Tutorial](#) and [Align to Two Points Tutorial](#).

## Setting the Transparency

When a new site plan is added to a project, the white colour is removed. This means that site plan documents with a white background will have the background removed, leaving just the line work for take-off or reference. If needed, you can remove the default colour to restore a white background or add different colours to be removed.

In instances where a site plan has various coloured areas, you may need to set multiple 'Mask Colours', one for each colour you wish to remove. There is a 'Tolerance' slider to control how strict the colour matching is.

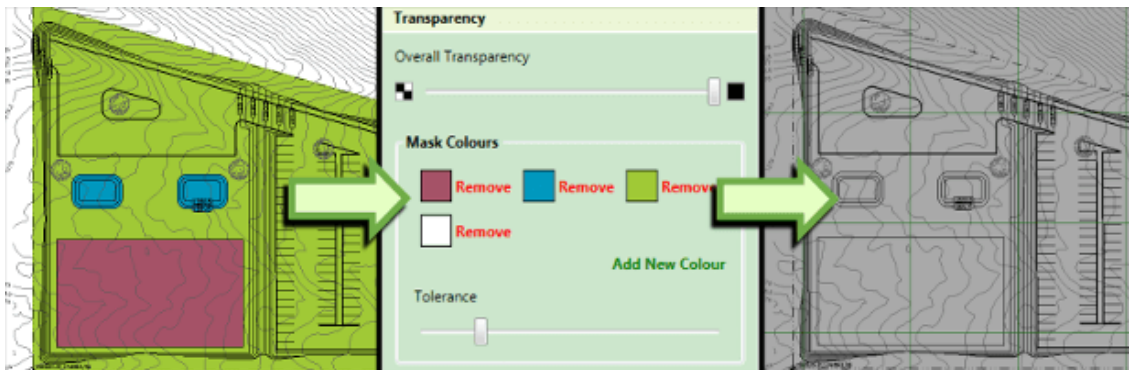

Since the site plan will be displayed on top of the existing terrain and earthworks, it is necessary to give it transparency, allowing visibility through the plan to the layers below. In many cases, the default transparency settings will be suitable. However, when the transparency needs to be adjusted, this can be achieved using the controls shown below.

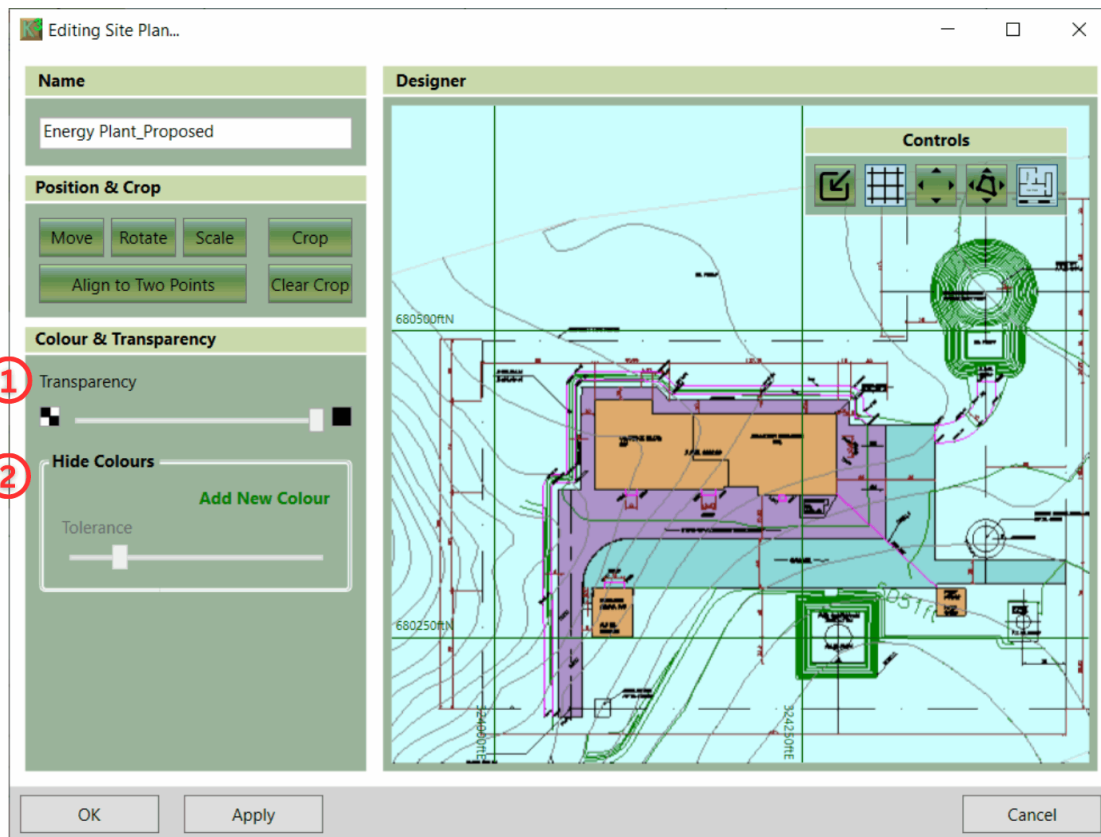

These controls work together as follows:

- ① This slider can be used to define the overall transparency to apply to the whole image. When set to its minimum (the default) there will be no overall transparency. As the slider is moved to the right, the overall transparency will increase until at the maximum value the image will completely disappear.
- ② These controls can be used to completely mask out specified colours. By default, there is a mask on white, which is the background colour for most drawings. Additional mask colours can be set by clicking 'Add New Colour' and then clicking a point on the preview to select a colour. Mask colours can be changed by clicking into the colour box and selecting a new colour on the screen, and they can be removed by clicking 'Remove'.

It is also possible to remove colours which are similar to the selected mask colour(s) by adjusting the tolerance slider. If the slider is set to its minimum, only exact matches on the mask colour(s) will be removed. As the tolerance value is increased more colours will be removed in a widening band around the specified colour(s).



The [Site Plans - Transparency](#) video explains the transparent background requirement and gives instructions on applying/removing transparency.

## Setting Visibility

There are multiple ways to display a site plan in a project.

**Default:** By default, site plans display in 2D and 3D views.

**Turn site plans on and off:**

There are multiple functions which turn site plans on and off.

1. Click 'Plans' in the top menu, hover over your site plan and click 'Hide' to turn off. Alternatively, go to 'Plans' → left-click the eyeball next to your plan name to switch off and on.
2. When a site plan is switched On in the 'Plans' menu, in each phase you have the option to display in 2D and 3D views. In the 'Display' panel, click on the 'Site Plan Visibility' button and select 'No Site Plans' to turn off and 'All Site Plans' to switch on and have site plans showing in 2D and 3D. This Site Plans toggle is also available in the pop-out editing window.
3. Only 2D on - When a site plan is switched On in the 'Plans' menu, in the 'Display' panel, click on the 'Site Plan Visibility' button and select 'Site Plans in 2D' views. This will turn 3D site plans view off.
4. Only 3D on - When a site plan is switched On in the 'Plans' menu, in the 'Display' panel, click on the 'Site Plan Visibility' button and select 'Site Plans in 3D'. This will turn 2D site plans views off.

### Site Plan Surfaces

Having selected your plan(s) to be displayed in 2D and 3D, or just one of the dimensions. You can then choose which surfaces of your project the site plans are displayed in. Consider your project to be made up of 3 surfaces:

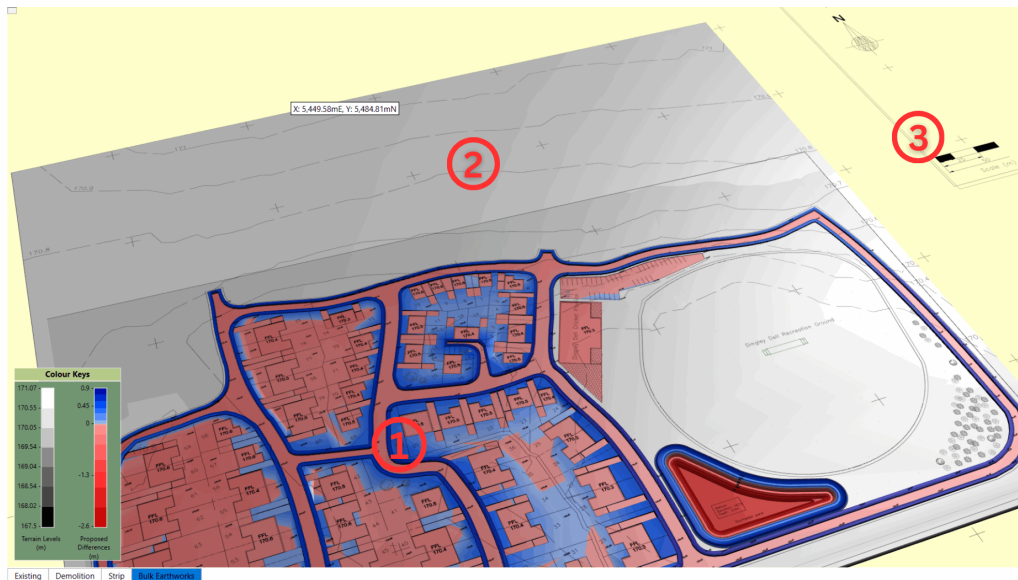

- ① Proposed - the area of disturbance within a phase
- ② Ground - the existing or ground level of a phase
- ③ Surround - the coloured background area outside of the model, which may show your site plan, where there is no ground or proposed topography.

To display your site plans on the different surfaces go to the 'Plans' menu and hover over your listed site plan to reveal the list and the option to 'Move Down' (Move Up will appear as an option once the site plan has been moved below "--Proposed--").

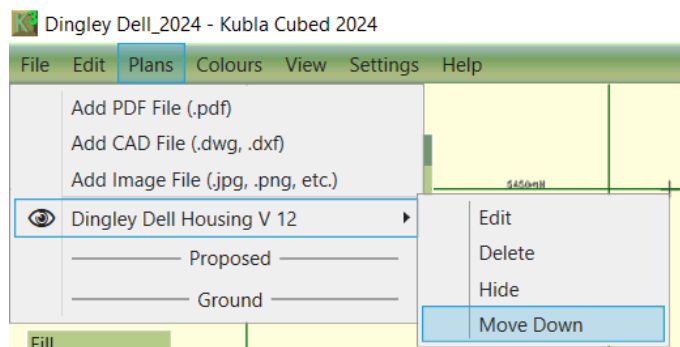

Below are the three view options:

**All surfaces on:** The site plan is at the top of the list, above "--Proposed--" so displays on all the surfaces of the project.

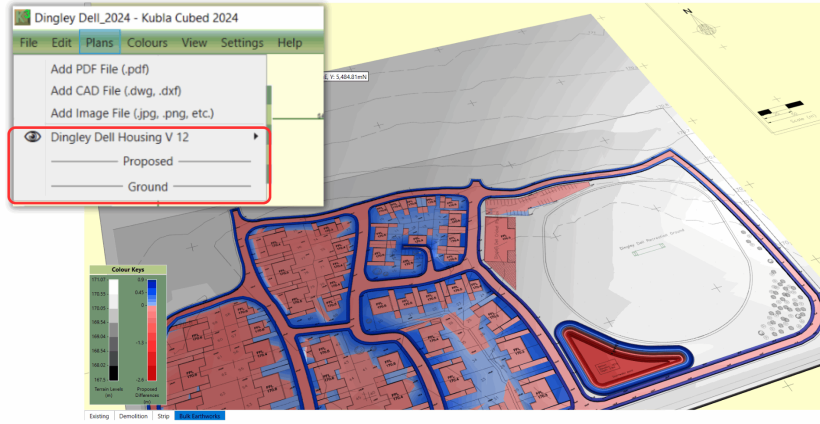

**Ground & Surround:** The site plan is between "--Proposed--" and "--Ground--" so displays on the Ground and Surround surfaces. (**Not** the Proposed)

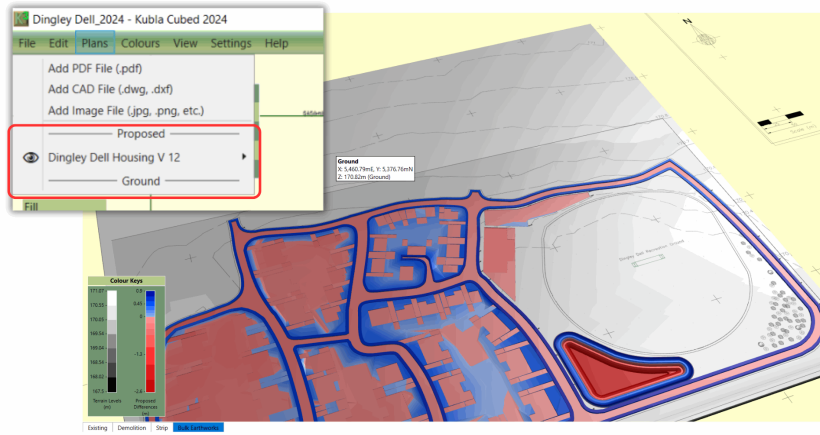

**Surround only:** The site plan is below the "--Ground--" so only shows on the Surround surface, i.e. not on the model (**Not** the Proposed or Ground).

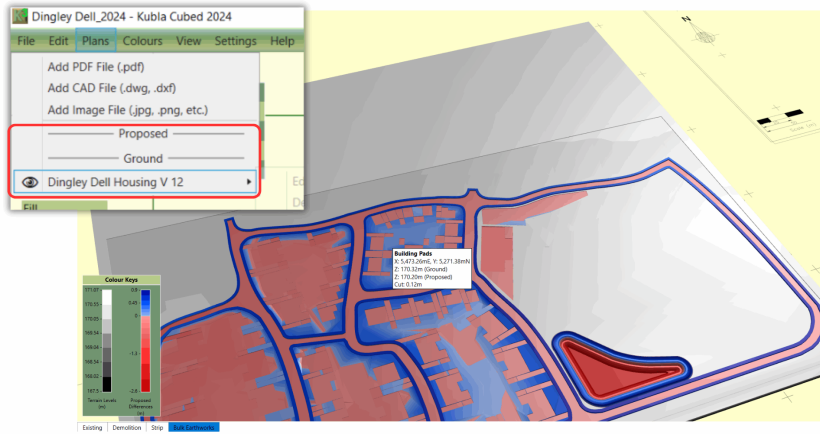

---

# Chapter 5

---

## Construction Phases

---

### Topics:

- [Overview](#)

Construction phases allow you to break your project into multiple phases of work. For example, a typical earthworks project would have a strip/reduce phase and a bulk earthworks phase as a minimum.

Understanding the concept of construction phases is key to making full use of *Kubla Cubed*



## Overview

In *Kubla Cubed* the tabs ① that run along the bottom of the screen are referred to as 'construction phases' or just 'phases'. **Elevation** and **Measurement** elements that you create will be added to the selected phase only, the volumes shown on the screen relate to the selected phase only rather than an accumulation of all volumes in the project.

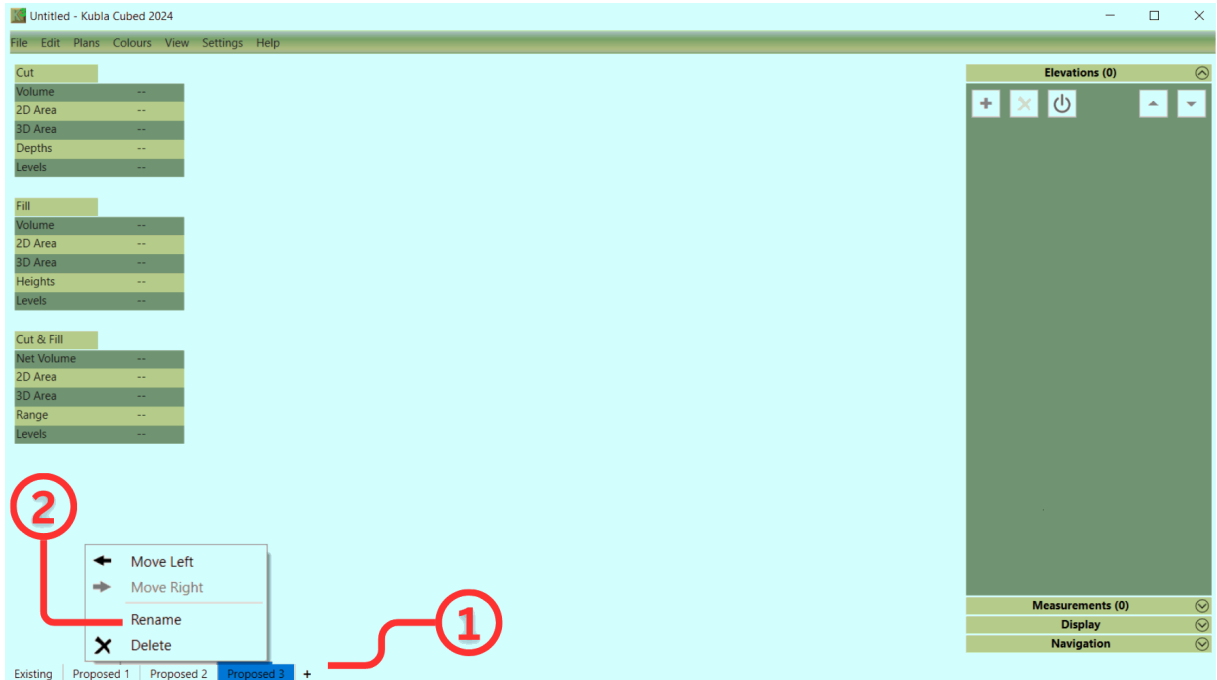

The first phase always contains the existing ground, any number of subsequent proposed phases can be created.

There are two main reasons to create more than one proposed phase:

1. It allows earthworks volumes and measurements to be separated into logical sections (e.g topsoil, bulk earthworks, paving).
2. It allows a new set of calculations to be completed using the proposed elevations of the previous phase as the new ground.

The second item is particularly important. Consider a backfill operation: in the first proposed phase you define a trench (Phase 1) which cuts into the existing ground and in the second proposed (Phase 2) you fill the trench in.

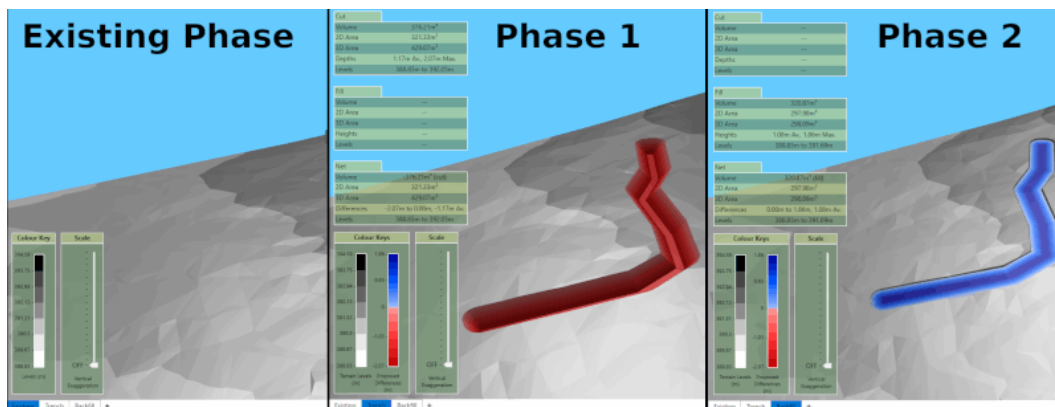

In *Kubla Cubed*, each phase conducts calculations on two surfaces: a ground surface (derived from the previous phase) and a proposed surface (defined with earthworks elements). Within a single phase, there is no way to calculate backfilling the trench because placing earthworks over the trench would overwrite that section of the proposed rather



than calculate a separate 'fill' volume. Earthworks elements within a single phase are combined to create a single proposed surface; they do not produce cut/fill volumes from intersecting with each other.

Instead, in this scenario, we must create another phase, effectively baking the result of the trench cut into the ground of the next phase. The ground of the new phase will inherit the proposed from the previous phase, so it is now possible to calculate backfilling the trench as part of a separate operation. Other common scenarios that require this approach include the completion of topsoil stripping or demolition before initiating bulk earthworks.

To **add** a new construction phase, click on the + button ① and type a name for the new phase. If you want to delete or rename a construction phase, **right-click** on the tab, and a menu will appear ② with these options.

To **move** a phase one place left or right, you can use the **right-click** menu. You can also drag and drop phases by pressing the **left mouse button** down on a phase and moving the pointer to the new position while keeping the mouse button down until it's in the drop position.



In our video [Understanding Construction Phases & Calculation Order](#), we discuss two critical concepts crucial for mastering the program.

---



---

# Chapter

# 6

---

## Elevation Elements

---

### Topics:

- [The Elements Panel](#)
- [Calculation Order](#)
- [Side Batters](#)
- [Absolute Elements](#)
- [Relative Elements](#)

*Kubla Cubed* provides multiple options to define earthwork levels. Some thought has to be given to the best earthworks elements to use in any given scenario. When required, a number of elements can be used together to create the proposed earthworks. Earthworks elements can be divided into two groups regarding how their elevations are defined :

- **Absolute Elements:** These elements are defined by explicit levels. The Platform, Slope, Path, Feature Surface and Triangle Surface all fall under this category. If they intersect with another element and are lower in the calculation order, they will effectively overwrite the element below.
- **Relative Elements:** The next type are Relative Elements. The Reduce, Raise, Trench and Berm elements come under this category. For these elements, you do not input a level but instead a depth or height by which to adjust the existing ground or the level already defined by elements lower in the calculation order. If these elements intersect with other elements lower in the calculation order, they do not overwrite them, instead, they will adjust their level up or down.

Whenever designing a proposed surface by combining multiple earthworks elements, it is essential to ensure that you are confident you have defined the level you intended. To check, hover the mouse cursor over various points on your designed surface to ensure the proposed Z value is what you expected. Please see the section on the [cursor label](#) for more information.

## The Elements Panel

Each phase in a project contains an 'Elevations' panel. This is where earthworks elevation elements such as Platforms, Slopes, Paths and Feature Surfaces can be added to the project. The Elevations elements in a panel are combined to create a single proposed surface within a single phase.

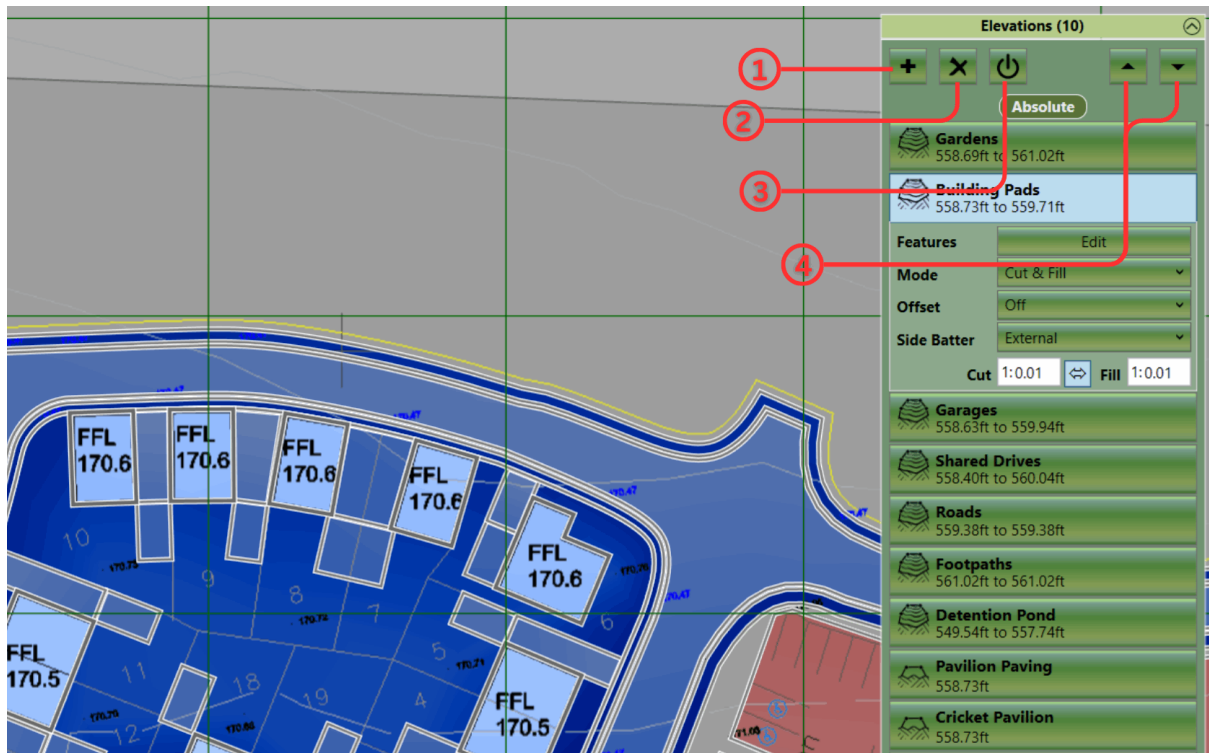

### Elevations Element Panel

- ① Add a new element - This opens the Element Menu.
- ② Delete an element - Deletes the selected element from the project.
- ③ Disable and Enable an element - Excludes or includes the element from the volume calculations.
- ④ Move an element in the calculation order - The arrows move the elements up and down the order.

### Adding Elements

New elements can be added to the 'Elevations' panel by clicking on the + symbol ①. You will be presented with the following list of elements that you can add:

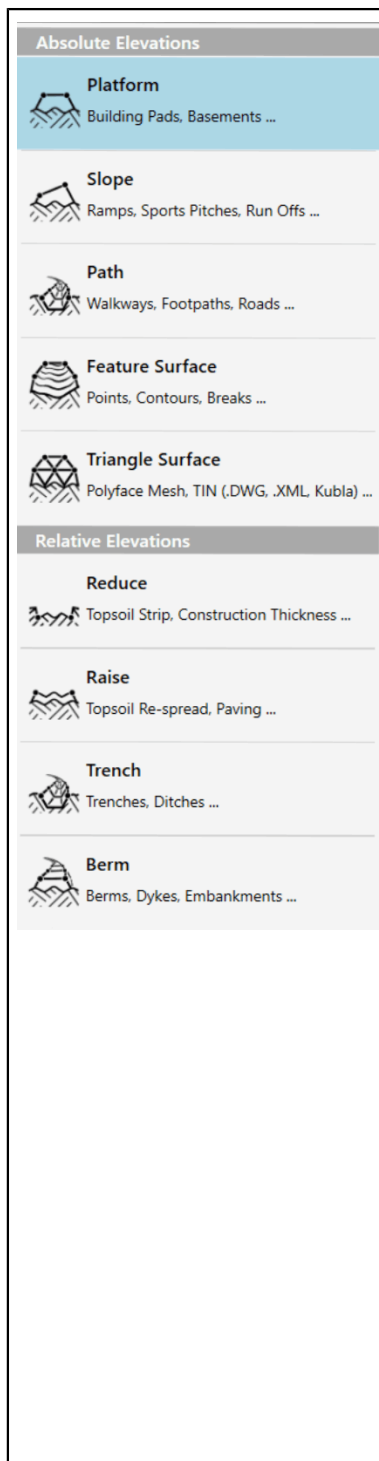

- **Platform**

The Platform element adds a specified area with a specified elevation to the site, i.e. a flat area. This is most commonly used for defining building pads and retention ponds. For more information see [Platform Element](#).

- **Slope**

The Slope element adds a specified area with a specified slope to the site. This is most commonly used for access ramps and run-offs. For more information see [Slope Element](#).

- **Path**

The Path element adds a path of a specified width with a specified centreline to the site. This is most commonly used for access roads and trenches. For more information see [Path Element](#).

- **Feature Surface**

The Feature Surface element adds a surface defined with elevation 'features' (outlines, contours, break-lines and points). This is most commonly used for take-offs such as those required by contractors for bidding purposes. For more information see [Feature Surface Element](#).

- **Triangle Surface**

The Triangle Surface element is used to define a surface using a triangulation imported from another file. This is most commonly used to import data from other programs which support triangulations (TINS). For more information see [Triangle Surface Element](#).

- **Reduce**

The Reduce element removes a specified thickness of material from a specified area of the site. This is very commonly used for stripping topsoil from the existing ground. For more information see [Reduce Element](#).

- **Raise**

The Raise element adds a specified thickness of material to a specified area of the site. This is most commonly used for paving. For more information see [Raise Element](#).

- **Trench**

The Trench element adds a trench of a specified width with a specified centreline to the site. This is most commonly used for utility trenches, etc. For more information see [Trench Element](#).

- **Berm**

The Berm element adds a berm of a specified width with a specified centreline to the site. This is most commonly used for embankments, dikes, etc. For more information see [Berm Element](#).

Once you have selected an element you will be able to start drawing its boundary or centreline points in the design area. **Left-click** to place a new point, **Right-click** or press **Enter** to complete the creation of the element. If you want to cancel the operation entirely, hit the **Esc** key. When adding new elements the **Backspace** key can be used to undo the last placed point if a mistake has been made.

### Renaming Elements

After an element is created, it is a good idea to give it a relevant name so it can be identified in the report (e.g. Building Pad 1 or Car Park). To do this just double click on the name of the element and then over-type.

## Editing Elements

- **Selection** : Elements can be selected by **left-clicking** on the title bar in the earthworks panel or by **left-clicking** on there boundary or centre lines in the design area. Multiple elements can be selected by holding down **Ctrl** whilst making the selection. To deselect an element you can **right-click** on it.
- **Edit Mode** : If you double click on an element it will enter into 'edit mode', the properties of the element will be exposed and you will be able to edit the definition points of the element in the design view. To exit 'edit mode' **double left-click** in empty space in the design view.
- **Definition Points** : When an element is in 'edit mode' the definition points of the boundary or centreline can be changed. In the design view **left-click** on a point and drag it to the desired position. A point can be deleted by using the **Delete** key. New points can be inserted by selecting a line and hitting the **Z** key. Points can also be edited directly in the point list in the element properties. Clicking on the top-left corner of the point list allows all the points to be copied using the menu command or **Ctrl+C**. Likewise a list of points can also be pasted into the point list from another program by clicking on the top-left corner and using menu paste command or **Ctrl+V**.
- **Notes on Point Snapping** : When creating or editing the definition points of a earthworks element it is possible to snap the points to other element definition points or to defined grid positions. To access the point snapping options click on the **Edit** menu and then the **Snap Points**. Here you can toggle snapping to boundary points and grid points as well as setting the interval and origin point of the grid used for snapping.

## Properties

For information on the individual element properties refer to the relevant sections for each element.

## Amending the Calculation Order

You can change the order of elements in the list by selecting an element and using the up down buttons ④. The order of earthworks becomes critically important when two or more earthworks intersect. The calculation order can change the way that the proposed surface is built and thus change the cut & fill estimate of a project. For more information refer to the [calculation order](#) section of the user guide.

## Copying & Pasting

It is often useful to copy and paste elements, this can be done using **Edit** menu commands or the keyboard shortcuts (**Ctrl+C**, **Ctrl+V**). You can copy and paste in the same phase to duplicate an element or copy and paste to move elements to different phases. See [Copy and Paste](#) on page 94.

## Deleting Elements

Elements can be deleted by first selecting them and then clicking on the X button at the top of the Elevations panel ②. (image above)

## Disable and Enable Elements

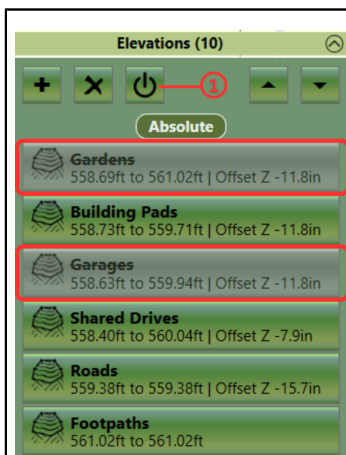

Elevation Elements can be toggled between enabled and disabled by first selecting them and then clicking on the power symbol button at the top of the panel ① (left). Disabled elements are greyed out and have their names struck through ② (left).

- Disabling an element has the same effect as temporarily deleting it, with the advantage that it does not need to be re-entered. Disabled elements will be excluded from the volume calculations, 2D and 3D displays, and the calculation order. As with deleting, any element dependent upon a disabled element will have its dependency set to “auto”. Disabled elements may also be edited; however, none of the changes will take effect until enabled.
- Enabling an element will reverse the disabling process and restore the element to its normal status.

- Selectively disabling and enabling elements provides flexibility in managing the display and can be useful in identifying the cause of calculation errors.

## Calculation Order

Note that the calculation order is only important if you have earthworks elements which intersect at different levels.

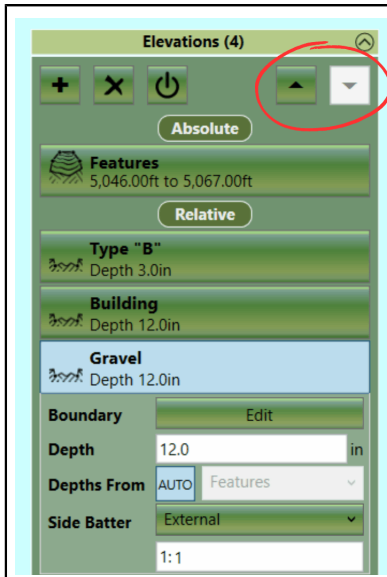

In *Kubla Cubed*, it is possible to have intersecting earthworks elements. However, this can introduce a complication since it must be specified whether the level in the intersection region will be controlled by one element or the other. This is dictated by the 'calculation order' - in effect the order that the earthworks elements are 'built' within the software.

Consider the following example, of two 'cut and fill' earthworks elements (see image below). If one element has a level of +10m and another is at +20m and they intersect, then what is the level of the resultant area where they intersect? In *Kubla Cubed*, the answer is that it will be the level of the element which is lower in the calculation order.

**Note:** Changing the calculation order may affect elements other than the one selected. For example, a Reduce element 'Reduce\_1' which has 'Depths From' set to a Platform called 'Platform\_1'... if 'Platform\_1' is moved to the bottom of the list, 'Reduce\_1's depth will be set from the next Absolute element above it.

The image below illustrates the example described above. These two elements intersect at different levels, and they are both in 'cut and fill' mode. If the element at +10m is above the element at +20m in the calculation order (left image), then the higher element will fill over the top of the lower element. However, if the calculation order of these two elements is reversed (right image) then the lower element will instead cut material out of the higher one.

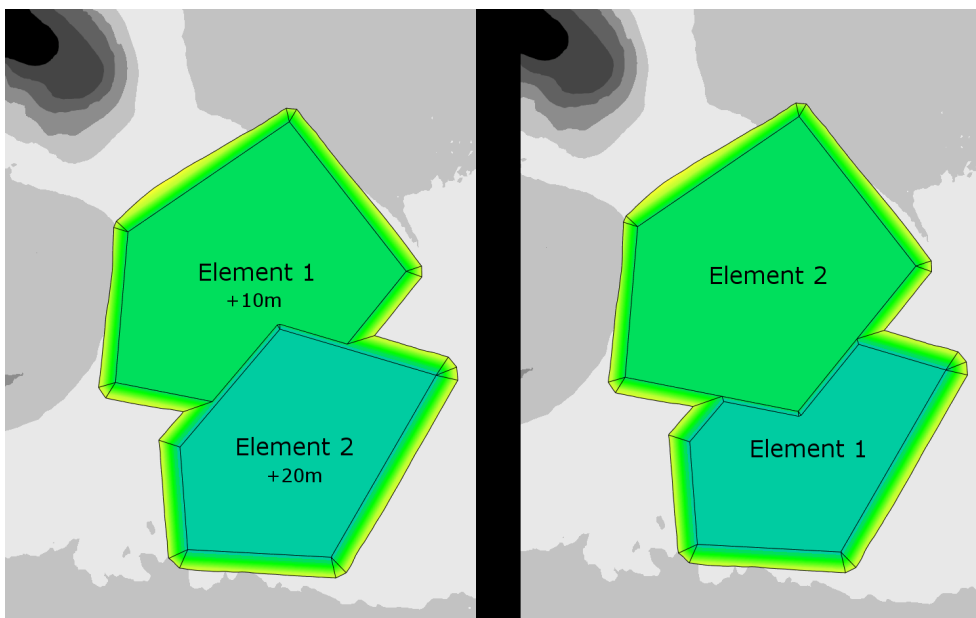



Mastering the program requires [Understanding Construction Phases & Calculation Order](#). These concepts are studied in context through scenarios and demos in the video.

## Side Batters

One powerful feature of *Kubla Cubed* is its ability to automatically generate side batters, the slope between the design ground levels and the existing ground. This is particularly crucial in projects where the batter angles can be quite low, such as coastal projects, and the volumes within these batters can represent a significant portion of the total volumes.

For each element, you can set the Side Batter ① to 'Off', 'External', or 'Internal' (limited). Then set the ratio ②. The Side Batter, set as a ratio of vertical to horizontal, determines the angle of the side slopes on an element. It is set to a default of 1:1.

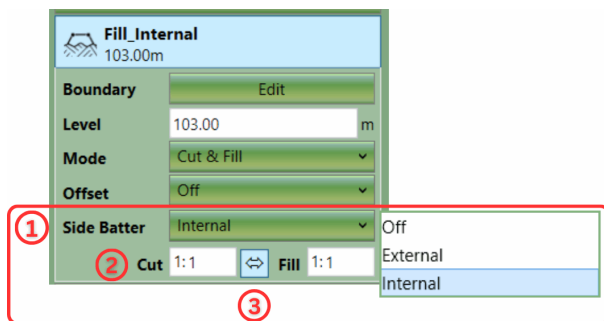

- Side Batter - External (default): Outward slope, exceeding the defined boundary.
- Side Batter - Internal: Inward slope from boundary.
- Side Batter - Off: Element joins ground with vertical sides.

However, instead of turning side batters 'Off', side batters of 1:0.01 are often recommended and more reliable. When multiple elements are side-by-side, they are easier to join if they have side batters set to 1:0.01. In practical terms, they are more or less the same thing. However, we have encountered problems related to vertical areas in the triangulation, so we use this trick to replace them with as steep a slope as possible. In most cases, this prevents/resolves triangulation issues.

### Set Side Batter Cut & Fill Independently

By default, cut and fill ratios are linked. When either the cut or fill is set, the other one automatically updates to the same ratio. The double arrow ③ between the two provides independent setting, allowing for different ratios. Left-click on the arrows to toggle on and off.

This is particularly useful in scenarios like rock excavation, where the cut requires a steep side batter, while the soil fill needs a gradual slope.

### Impact of Side Batter

The images below shows how the side batter impacts the cut and fill volume for 6 identical circle platforms. In this example, all of the circle boundaries are identical in shape, with either a cut or fill of 3 metres. In the 2D view (below), the incline lines show the direction of the external and internal side batters. This is something to bare in mind when altering the side batter settings.



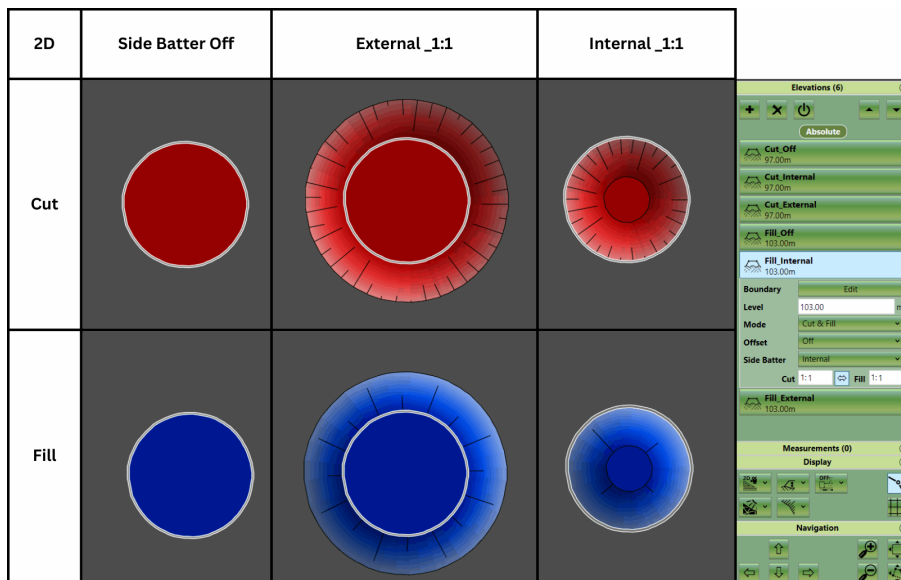

The 3D view (below), emphasizes the varied results based on the style of the side batter.

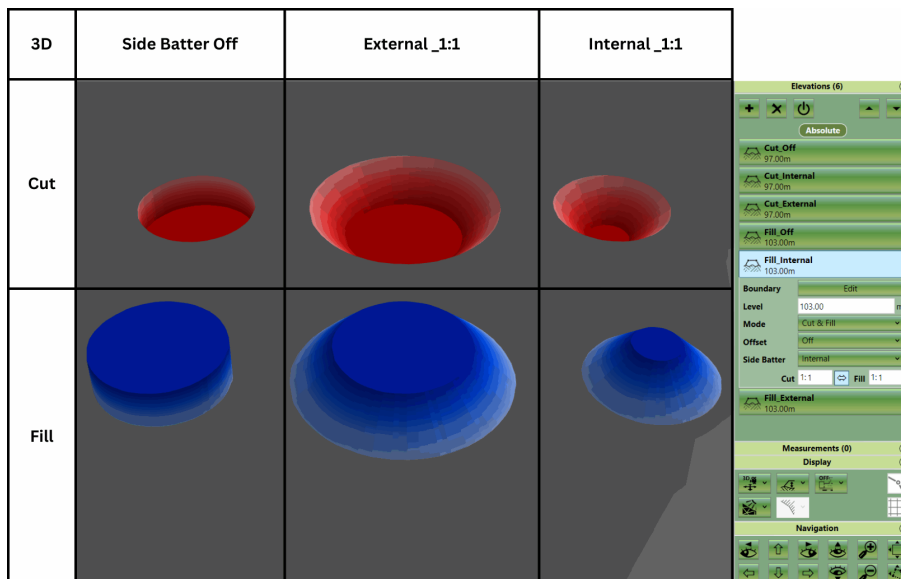

### When to use External Side Batters?

This is the default and is frequently used for most elements.

### When to use Internal Side Batters?

Commonly used when you know the extent of a boundary and need to excavate into it. For example, a pond or open-cast mine.

### When to turn Side Batter's Off?

Vertical side batters are commonly used for topsoil/site strips, when the reduction is relatively small. As mentioned earlier, they are used when there are elements side-by-side to enable clean joining without intersecting side slopes. A notable use case is a housing project when you have building pads, garages, and driveways are in close proximity.

## Absolute Elements

Platform, Slope, Path, Feature Surface & Triangle Surface, are all absolute element types.

Absolute elements are those that are specified to a fixed datum. For instance, elevations that are specified from Mean Sea Level (MSL) are considered absolute elevations in *Kubla Cubed*. On a typical site plan, most hard landscape elevations are marked with absolute elevations. Operations like topsoil strip and re-spread will often be described with relative elevations, but they are frequently noted in project documentation rather than on the plan itself.

Absolute elevation elements offer various methods of specifying elevations. The 'Platform' element is specified with a single value as it represents a horizontal plane. The 'Slope' element, also a plane but inclined, can be defined with three points or an incline arrow. The 'Feature Surface' elevations are defined with a number of elevation features (contours, break lines and points), and the Triangle Surface elevations are taken from the imported triangles.

In contrast to [relative elements](#), absolute elements do not have a 'Depth From' or 'Heights From' field, but they do include an 'Offset' option. Offsets allow you to move all the points in an element by a set amount, utilised to adjust to subgrade variations in certain workflows. Elements defined with absolute elevations cannot adjust elevations from preceding elements in the calculation order, unlike relative elements. Absolute elements explicitly define the proposed level, completely overriding all previous elements in the calculation order when they intersect. This capability can be highly advantageous, allowing projects to be built up in different layers. For example, one element may be used to specify general elevations, and additional elements can be added with more detail in specific critical areas without having to snap the boundaries together.

## Platform Element

The Platform element is used to add an area with a fixed elevation to the site. This element is most commonly used for building pads.

The properties that are exposed for the platform element are summarised below.

The screenshot shows a software interface for configuring a Platform element. At the top, there is a tab labeled 'Absolute'. Below it, the element is identified as 'Platform' with a value of '420.28ft'. The settings are organized into several sections: 'Boundary' with an 'Edit' button; 'Level' with a text input field containing '420.28' and a unit dropdown set to 'ft'; 'Mode' with a dropdown menu set to 'Cut & Fill'; 'Offset' with a dropdown menu set to 'Off'; 'Side Batter' with a dropdown menu set to 'External'; and at the bottom, 'Cut' and 'Fill' ratios both set to '1:1', with a double-headed arrow button between them.

- **Boundary**

The Boundary Edit button provides access to the editor where the definition points can be defined for the outline of the platform area.

- **Level**

This is the level that the platform area should be (subject to any offset defined below).

- **Mode**

This is used to specify if the element should have Cut, Fill or both. Most commonly Cut & Fill will be specified.

- **Offset**

The offset option is mostly used to add construction thicknesses by specifying a negative offset. The options are Off, Z or it allows you to offset the entire surface in X,Y and Z. This is useful for accommodating for a construction thickness or finding a balance.

- **Side Batter**

The Platform boundary is joined to the ground by side slopes. The [side batter](#) (set as a ratio of vertical to horizontal), dictate the angle of these slopes. You can set the side batter to either External or Internal and specify different side batter angles for side slopes that cut into the ground and for those that fill into it. Turning side batter off will result in the Platform being joined to the ground with vertical sides.

Between the Cut and Fill ratios is a double-arrow button which, when depressed, will synchronise Side Batters.



This video provides an overview of the Platform element's options for defining a fixed, flat area of proposed ground [Proposed Levels - Platform Element](#)

## Slope Element

The slope element is used to define a specified area with a uniform incline. This element is most commonly used for access ramps, sports pitches and run-offs.

The properties that are exposed for this element are summarised below.

- **Boundary**

The Boundary Edit button provides access to the editor wherein the definition points can be defined for the points which define the outline of the slope area.

- **Define By**

This option selects the controls you use to define the slope incline and elevation. The '3 Points' option can be used to define the plane of the slope. '3 Points & Offset' allows you to accommodate for a construction thickness. The other options are 'Arrow' and 'Arrow & Offset'. Using the arrow, you can specify a single elevation and an incline angle to define the slope or two elevations and allow the software to calculate the incline angle for you (for more details see below).

- **Level**

This table specifies the points with levels that define the slope.

- **Incline**

This shows the ratio of the incline after creating a slope. Or input the ratio required.

- **Mode**

This is used to specify if the element should have Cut, Fill or both. Most commonly Cut & Fill will be specified.

- **Offset**

The offset option is mostly used to add construction thicknesses by specifying a negative offset. The options are Off, Z or it allows you to offset the entire surface in X,Y and Z. This is useful for accommodating for a construction thickness or finding a balance.

- **Side Batter**

The slope boundary is joined to the ground by side slopes. The [Side Batters](#) on page 52 (set as a ratio of vertical to horizontal), dictate the angle of these slopes. You can set the side batter to either External or Internal and specify different side batter angles for side slopes that cut into the ground and for those that fill into it. Turning side batter off will result in the slope being joined to the ground with vertical sides.

Between the Cut and Fill ratios is a double-arrow button which, when depressed, will synchronise Side Batters.

### Option 1: Three Points

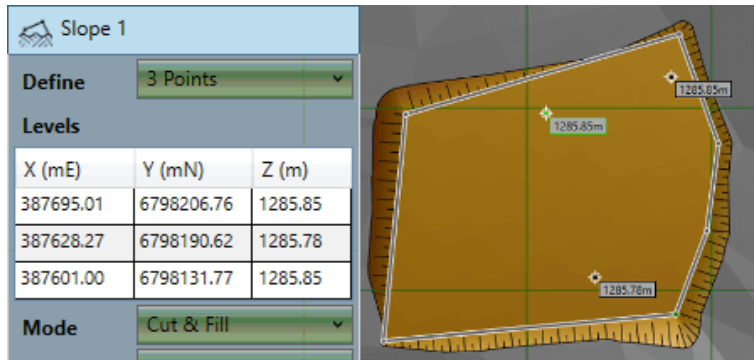

This option allows you to define a slope using three points. Three points explicitly define a plane. This option is more technical than the other options but can be useful if there are three elevations clearly marked on the drawing to use as reference.

### Option 2: Arrow Base

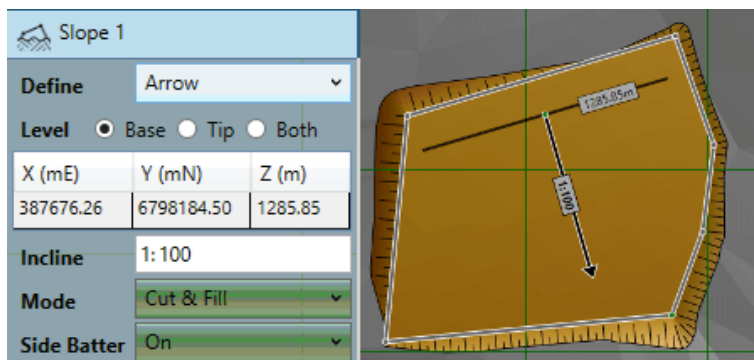

This option allows you to define the slope with a single elevation at the base, an incline angle and a direction specified by the arrow. The arrow position can be controlled by dragging the tip, shaft or base of the arrow. The length of the arrow has no effect on the slope with this option.

### Option 3: Arrow Tip

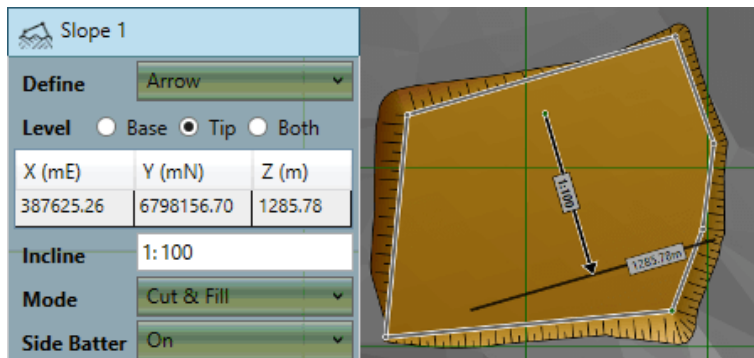

This option is similar to using an arrow and a base elevation but instead of specifying the elevation at the base of the arrow you specify one at the tip. Again, the arrow position can be controlled by dragging the tip, shaft or base of the arrow. The length of the arrow has no effect on the slope with this option.

### Option 4: Arrow Both

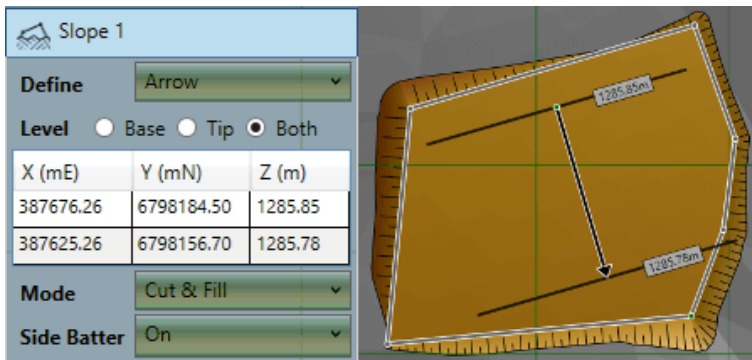

This option allows you to set the elevation of both the base and the tip of the arrow leaving the software to calculate the incline angle for you. This can be especially useful when creating ramps from one area to another when you know both elevations. You can move the arrow at the base and the incline of the ramp will adjust accordingly.



[Proposed Earthworks : The Slope Element](#) video demonstrates slope creation by setting the incline with the arrow tool or via three values. Learn how to build ramps, run-offs, and other sloping areas.

## Path Element

The path element is used to define a path with a fixed width and defined levels. This element is most commonly used for roads and trenches.

The properties that are exposed for this element are summarised below.



- **Boundary**

The Boundary Edit button provides access to the editor wherein the definition points can be defined for the outline as well as the levels (or depths) for the path.

- **Width**

This is the width of the path.

- **Mode**

This is used to specify if the element should have cut, fill or both. Most commonly cut and fill will be specified.

- **Offset**

The offset option is mostly used to add construction thicknesses by specifying a negative offset. The options are Off, Z or it allows you to offset the entire surface in X,Y and Z. This is useful for accommodating for a construction thickness or finding a balance.

- **Side Batter**

The Path boundary is joined to the ground by side slopes. The [Side Batters](#) on page 52 (set as a ratio of vertical to horizontal), dictate the angle of these slopes. You can set the side batter to either External or Off and specify different side batter angles for side slopes that cut into the

ground and for those that fill into it. Turning side batter off will result in the Path being joined to the ground with vertical sides.

Between the Cut and Fill ratios is a double-arrow button which, when depressed, will synchronise Side Batters.



Estimate linear structures such as trenches, roads and causeways with the [Proposed Earthworks : The Path](#) video. For more **complex roads**, consider using a Feature Surface with varying level outlines and a centre line (defined by a break-line), or contours.

## Feature Surface Element

The feature surface element is used to define a complex surface specified by outlines, contours, break-lines and points. This element is most commonly used for take-offs such as those needed by contractors for bidding purposes.

The properties that are exposed for this element are summarised below.



- **Features**

The Features Edit button will open the take-off window so that you can define the outlines, contours, break-lines and points which define this surface. For more information on the options available in the take-off window see [Elements Panel](#)

- **Mode**

This is used to specify if the surface should have cut, fill or both. Most commonly cut and fill will be specified.

- **Offset**

The offset option is mostly used to add construction thicknesses by specifying a negative offset. The options are Off, Z or it allows you to offset the entire surface in X,Y and Z. This is useful for accommodating for a construction thickness or finding a balance.

- **Side Batter**

The Feature Surface boundary is joined to the ground by side slopes. The [Side Batters](#) on page 52 (set as a ratio of vertical to horizontal), dictate the angle of these slopes. You can set the side batter to either External or Internal and specify different side batter angles for side slopes that cut into the ground and for those that fill into it. Turning side batter off will result in the Feature Surface being joined to the ground with vertical sides.

Between the Cut and Fill ratios is a double-arrow button which, when depressed, will synchronise Side Batters.



Sometimes called a super element for its ability to produce the results of any other element, the 'Feature Surface' is described in the video [Proposed Levels - Feature Surface](#) .

## Triangle Surface Element

The triangle surface element is used to add a triangulation into a project that has been originally created in another program (or Kubla Cubed project). The triangles cannot be edited once they are added to the project, all triangulation data needs to be imported from a file. The triangle surface supports importing data from LandXML (.xml), CAD (.dxf, .dwg) and Kubla Project files (.kcp).

The properties that are exposed for this element are summarised below.

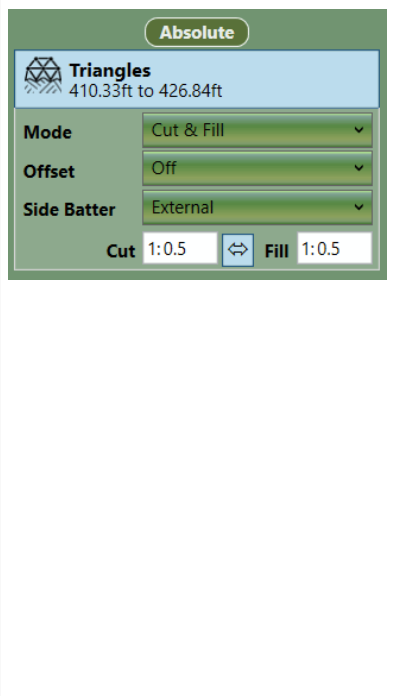
	<ul style="list-style-type: none"> <li> <b>Mode</b>            This is used to specify if the surface should have cut, fill or both. Most commonly cut and fill will be specified.         </li> <li> <b>Offset</b>            The offset option is mostly used to add construction thicknesses by specifying a negative offset. The options are Off, Z or it allows you to offset the entire surface in X,Y and Z. This is useful for accommodating for a construction thickness or finding a balance.         </li> <li> <b>Side Batter</b>            The triangle surface boundary is joined to the ground by side slopes. The <a href="#">Side Batters</a> on page 52 (set as a ratio of vertical to horizontal), dictate the angle of these slopes. You can set the side batter to either External or Internal and specify different side batter angles for side slopes that cut into the ground and for those that fill into it. Turning side batter off will result in the triangle surface being joined to the ground with vertical sides.             Between the Cut and Fill ratios is a double-arrow button which, when depressed, will synchronise Side Batters.         </li> </ul>
--	--



The [Existing Levels - Triangle Surface](#) video offers a thorough study of the Triangle Surface and importing TIN data into your project from various sources. LandXML files, imported via the Triangle Surface, are extensively covered in our video [Working with LandXML Files \(.xml\)](#).

## Relative Elements

[Reduce](#), [Raise](#), [Trench](#) and [Berm](#), are all Relative element types.

In *Kubla Cubed*, relative elements are those that are specified with heights or depths. For instance, a trench defined as 2ft below the ground surface is characterised by a relative depth. The alternative form, ‘[absolute elevations](#)’ would have elevations defined from a fixed datum (e.g., 156m from Sea Level). Typically, existing terrain is defined with absolute elevations whereas proposed terrain can be defined with a combination of relative and absolute elevations. For example, a topsoil strip is almost always defined with relative elevations (e.g. 1 ft topsoil strip), whereas building pads are defined with absolute elevations (e.g. 245ft FFL).

Each element that is defined by depths has an inverted counterpart defined by heights. The Trench has depth values, while the Berm has height values, both are defined by a centreline. Similarly, the Reduce element's opposite number is the Raise element. You can specify heights in a depth element and/or depths in a height element, by using negative values.

Relative elements all have a property called ‘Depths From’ or ‘Heights From’. This property allows you to specify the surface to which the elevations are relative. An obvious choice is to make them relative to the ground surface,



meaning they will override each other in areas of intersection, with the element lower in the calculation order taking precedence. However, having the elevations relative to ground is not always desirable. For instance, if you wanted to reduce a slab level for a material thickness in a specific area, you would want the depths defined from the slab level, not the ground. The ability to change what the depths/heights are relative to is extremely powerful, allowing you to adjust the surface of lower elements in the calculation order, as well as the ground. In 'Depths/Heights From', you can select 'Ground', the 'Previous Element' or a named element.

When the 'Auto' option is active, the option is dynamically set to the first absolute element above it in the calculation order. If there aren't any, it is set to ground. It can be conceptually confusing to have relative elements adjust each other, especially for new users to the program, so the auto option ensures the relative elements adjust only from previous absolute elements in the calculation order or ground if no absolute elements are found. The option is dynamic so you can add and remove elements, and all the relative adjustments elements will update accordingly.

## Reduce Element

The Reduce element is used to remove a fixed thickness of material from an area of the site. This element is most commonly used for stripping topsoil at the start of a project and for making subgrade adjustments.

The properties that are exposed for the Reduce element are summarised below.

- **Boundary**

The Boundary button provides access to the editor where the definition points can be defined for the outline of the Reduce area.

- **Depth**

This is the depth of material that you wish to remove from the Reduce area.

- **Depths From**

This setting dictates from what surface the specified depths are relative to. 'Ground' can be selected, or you can select the 'Previous Element' if you want the depths to be relative to the surface when the previous element in the calculation order is built. You can also select a named element. When the 'Auto' option is active 'Depths From' is dynamically set to the first absolute element above it in the calculation order. If there aren't any, it is set to ground. The behaviour when 'Auto' is active is desirable in most circumstances.

- **Side Batter**

The Reduce boundary is joined to the ground by side slopes. The [Side Batters](#) on page 52 (set as a ratio of vertical to horizontal) dictate the angle of these slopes. You can set the side batter to either External or Internal. Turning side batter off will result in the Reduce being joined to the ground with vertical sides.

Between the Cut and Fill ratios is a double-arrow button which, when depressed, will synchronise Side Batters.



[Topsoil Stripping](#) demonstrates using the Reduce element for topsoil stripping operations and explains the importance of defining strip depths in a separate phase to subsequent earthwork elevations.



## Raise Element

The Raise element is used to add a fixed thickness of material to an area of the site. This element is most commonly used for adding paving or topsoil.

The properties that are exposed for the Raise element are summarised below.

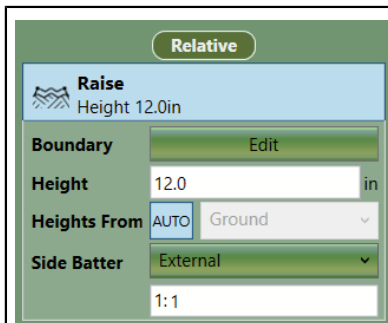

- **Boundary**

Boundary button provides access to the editor whereby the definition points can be defined for the outline of the Raise area.

- **Height**

This is the height of material that you wish to add from the Raise area.

- **Heights From**

This setting dictates from what surface the specified heights are relative to. 'Ground' can be selected or you can select the 'Previous Element' if you want the heights to be relative to the surface when the previous element in the calculation order is built. You can also select a named element. When the 'Auto' option is active 'Heights From' is dynamically set to the first absolute element above it in the calculation order. If there aren't any, it is set to ground. The behaviour when 'Auto' is active is desirable in most circumstances.

- **Side Batter**

The Raise boundary is joined to the ground by side slopes. The [Side Batters](#) on page 52 (set as a ratio of vertical to horizontal) dictate the angle of these slopes. You can set the side batter to either External or Internal. Turning side batter off will result in the Raise being joined to the ground with vertical sides.

Between the Cut and Fill ratios is a double-arrow button which, when depressed, will synchronise Side Batters.

## Trench Element

The Trench element is used to define a linear path with a fixed width and defined depths. This element is most commonly used for trenches.

The properties that are exposed for this element are summarised below.

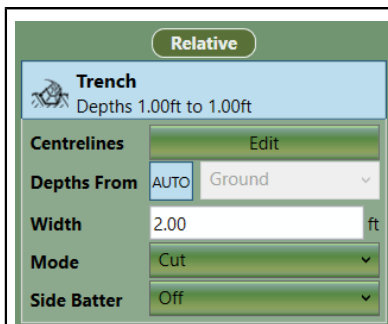

- **Centrelines**

The edit button will open the take-off window so that you can define the centrelines which define the Trench.

**Note:** Depths are specified with positive values

- **Depths From**

This setting dictates from what surface the specified depths are relative to. 'Ground' can be selected or you can select the 'Previous Element' if you want the depths to be relative to the surface when the previous element in the calculation order is built. You can also select a named element. When the 'Auto' option is active 'Depths From' is dynamically set to the first absolute element above it in the calculation order. If there aren't any, it is set to ground. The behaviour when 'Auto' is active is desirable in most circumstances.

- **Width**

This is the width of the path.

- **Mode**

This is used to specify if the element should have cut, fill or both. Most commonly cut and fill will be specified.

- **Side Batter**

The Trench boundary is joined to the ground by side slopes. The [Side Batters](#) on page 52 (set as a ratio of vertical to horizontal) dictate the angle of these slopes. You can set different side batter angles for side slopes that cut into the ground and for those that fill into it. You can set the side batter to either External or Off. Turning side batter Off will result in the Trench being joined to the ground with vertical sides.

Between the Cut and Fill ratios is a double-arrow button which, when depressed, will synchronise Side Batters.



Estimate linear structures such as trenches, roads and causeways with the [Proposed Earthworks : The Path](#) video. For more **complex roads**, consider using a Feature Surface with varying level outlines and a centre line (defined by a break-line), or contours.

## Berm Element

The Berm element is used to define a raised linear path with a fixed width and variable heights. This element is most commonly used embankments.

The properties that are exposed for this element are summarised below.

- **Centrelines**

Edit button provides access to the editor wherein the definition points can be defined for the outline as well as the heights for the Berm.

- **Heights From**

This setting dictates from what surface the specified heights are relative to. 'Ground' can be selected or you can select the 'Previous Element' if you want the heights to be relative to the surface when the previous element in the calculation order is built. You can also select a named element. When the 'Auto' option is active 'Heights From' is dynamically set to the first absolute element above it in the calculation order. If there aren't any, it is set to ground. The behaviour when 'Auto' is active is desirable in most circumstances.

- **Width**

This is the width of the Berm.

- **Mode**

This is used to specify if the element should have cut, fill or both. Most commonly cut and fill will be specified.

- **Side Batter**

The Berm boundary is joined to the ground by side slopes. The [Side Batters](#) on page 52 (set as a ratio of vertical to horizontal) dictate the angle of these slopes. You can set different side batter angles for side slopes that cut into the ground and for those that fill into it. You can set

the side batter to either External or Off. Turning side batter off will result in the Berm being joined to the ground with vertical sides.

Between the Cut and Fill is a button which (when depressed) will synchronise Side Batters.



Estimate linear structures such as trenches, roads and causeways with the [Proposed Earthworks : The Path](#) video. For more **complex roads**, consider using a Feature Surface with varying level outlines and a centre line (defined by a break-line), or contours.



---

# Chapter

# 7

---

## Measurement Elements

---

### Topics:

- [The Measurements Panel](#)
- [Count Element](#)
- [Length Element](#)
- [Area Element](#)
- [Volume Region Element](#)
- [Volume Region - Batch Create](#)
- [Cross Section Element](#)

*Kubla Cubed* offers five distinct measurement elements that can be drawn on screen to focus on specific parts of the model. Data related to these elements can be viewed in the various exports, such as spreadsheet exports and reports. Note, that there other measurement tools available, which are described in separate sections.

## The Measurements Panel

Each phase in a project contains a measurements panel. This is where additional measurements, such as counts, lengths, areas and cut/fill in specific regions, can be added to the project. There is no requirement to add any elements to the measurements panel as a lot of data is reported in the standard report. However, some supplementary measurements are often required in addition to the standard information.

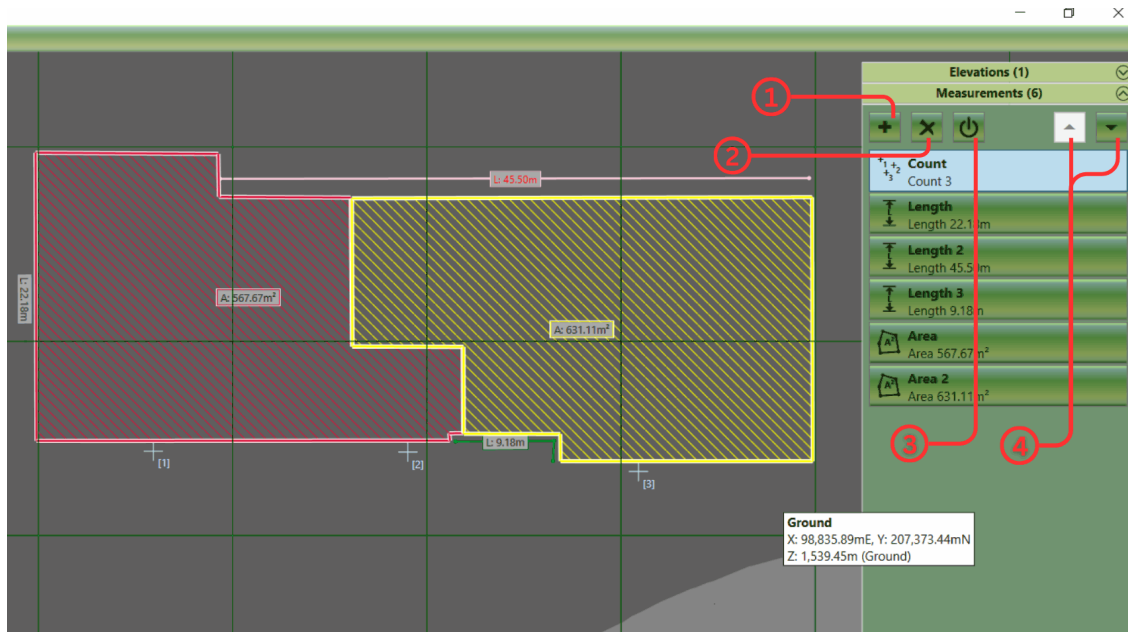





### Measurements Element Panel

- ① Add new element - This opens the Element Menu.
- ② Delete an element - deletes the selected element from the project.
- ③ Disable and Enable an element - excludes or includes the element from the volume calculations.
- ④ Move an element - the arrows move the elements up and down the order.

### Adding Elements

New elements can be added to the measurements panel by clicking on the + symbol ①. You will be presented with the following list of elements that you can add :

<p><b>1D &amp; 2D Measurements</b></p>	<ul style="list-style-type: none"> <li>• <b>Count</b></li> </ul>
<p> <b>Count</b> Items, Sets, Objects ...</p>	<p>The Count element allows you to record the position and number of various groups of assets on the site. You can use a Count element to record the position of manholes or count the number of trees. For more information, see the <a href="#">Count Element</a>.</p>
<p> <b>Length</b> Lengths, Distances, Paths...</p>	<ul style="list-style-type: none"> <li>• <b>Length</b></li> </ul> <p>The Length element allows you to measure distances on the site as well as record assets that have a length property, such as kerbs and fences. Length elements can be closed to measure perimeters. It is worth noting that all earthworks elements report a boundary outline perimeter in the input data summary so there is no need to trace a line around any earthworks element. For more information see the <a href="#">Length Element</a>.</p>
<p> <b>Area</b> Areas, Perimeters ...</p>	<ul style="list-style-type: none"> <li>• <b>Area</b></li> </ul> <p>The Area element is used for measuring areas in the project. Areas of earthworks disturbance are recorded in the estimation summary, so there is no need to measure these. Area elements only measure 2D areas, as if they were measured from a paper plan. They don't measure the 3D surface area that can be found in the 'Estimation' report. For more information, see the <a href="#">Area Element</a>.</p>
<p><b>3D Measurements</b></p>	<ul style="list-style-type: none"> <li>• <b>Area</b></li> </ul>
<p> <b>Volume Region</b> Cut\Fill in Specific Region.</p>	<p>The Area element is used for measuring areas in the project. Areas of earthworks disturbance are recorded in the estimation summary, so there is no need to measure these. Area elements only measure 2D areas, as if they were measured from a paper plan. They don't measure the 3D surface area that can be found in the 'Estimation' report. For more information, see the <a href="#">Area Element</a>.</p>
<p> <b>Cross Section</b> A 2D Slice through the Terrain.</p>	<ul style="list-style-type: none"> <li>• <b>Volume Region</b></li> </ul> <p>The Volume Region element is used for reporting cut\fill in different regions of a particular phase. It is worth noting that there is no requirement to have any volume regions in a phase. If none are defined, the 'Estimation' report will still show a breakdown by element and results for all earthworks in the phase. For more information, see the <a href="#">Volume Region Element</a>.</p>
	<ul style="list-style-type: none"> <li>• <b>Cross Section</b></li> </ul> <p>The Cross Section element is used for visualising a cut through the terrain, displaying the existing and proposed terrain along the cross section. The cross section can be viewed in the software, and is also presented in some of the exports. For more information, see the <a href="#">Cross Section Element</a>.</p>

When you have selected an element, you will be able to start drawing its boundary, centreline, or points in the design area. Left-click to place a new point, **right-click** or press **Enter** to complete the creation of the element. If you want to cancel the operation entirely, hit **Esc** key. When adding new elements, the **back space** key can be used to undo the last placed point if a mistake has been made.

### Renaming Elements

After creating an element, it is a good idea to give it a relevant name so it can be identified in the report (e.g., 'boundary fence' or 'flower bed'). To do this, just double-click on the name of the element and then type over it.

### Editing Elements

- **Selection** : Elements can be selected by **left-clicking** on the title bar in the earthworks panel or by **left-clicking** on a elements boundary or centre lines in the design area. Multiple elements can be selected by holding down **Ctrl** while making the selection. To deselect an element, you can **right-click** on it.
- **Edit Mode** : If you double-click on an element it will enter into 'edit mode', and the properties of the element will be exposed. You will be able to edit the definition points of the element in the design view. To exit 'edit mode'; **double left-click** in empty space in the design view.

- **Definition Points :** When an element is in 'edit mode', the definition points of the boundary or centreline can be changed. In the design view, **left-click** on a point and drag it to the desired position. A point can be deleted by using the **Delete** key. New points can be inserted by selecting a line and hitting the **Z** key. Points can also be edited directly in the point list in the element properties. Clicking on the top-left corner of the point list allows all the points to be copied using the menu command or **Ctrl+C**. Likewise, a list of points can also be pasted into the point list from another program by clicking on the top-left corner and using menu paste command or **Ctrl+V**.
- **Notes on Point Snapping :** When creating or editing the definition points of a measurement element, it is possible to snap the points to other element definition points or to defined grid positions. To access the point snapping options, click on the Edit menu and then the Snap Points. Here, you can toggle snapping to boundary points and grid points, as well as setting the interval and origin point of the grid used for snapping.

## Properties

For information on the individual element properties, refer to the relevant sections for each element.

## Amending the Order

You can change the order of elements in the list by selecting an element and using the up-down buttons ④. Unlike the elevations panel where the order of the earthworks can change the proposed elevations, the order of measurement elements has little consequence apart from changing which element shows on top if two intersect, or the order they appear in export files. You may want to change the order of elements so similar measurements are grouped together.

## Copying & Pasting

It is often useful to copy and paste elements; this can be done using Edit menu commands or the keyboard shortcuts (**Ctrl+C**, **Ctrl+V**). You can copy and paste in the same phase to duplicate an element or copy and paste to move elements to different phases. See, [Copy and Paste](#) on page 94.

## Deleting Elements

Elements can be deleted by first selecting them and then clicking on the 'X' button at the top of the panel ② (image above).

## Disable and Enable Elements:

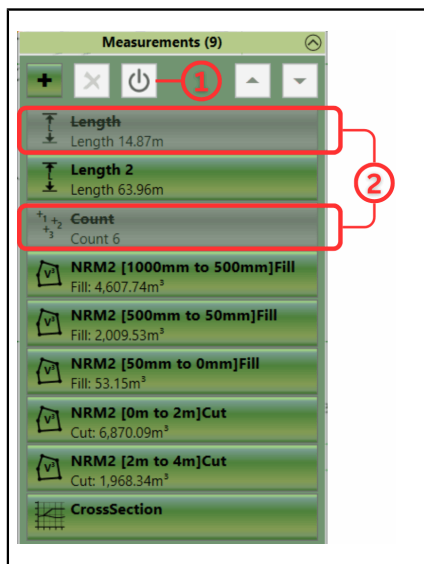

Measurement Elements can be toggled between enabled and disabled by first selecting them and then clicking on the power symbol button at the top of the panel ① (left). Disabled elements are greyed out and have their names struck through ② (left).

- Disabling an element has the same effect as temporarily deleting it, with the advantage that it does not need to be re-entered. Disabled elements may also be edited; however, none of the changes will take effect until enabled.
- Enabling an element will reverse the disabling process and restore the element to its normal status.
- Selectively disabling and enabling elements provides flexibility in managing the display. Measurement Elements do not impact the volume calculations.



## Count Element

The Count element allows you to record the position and number of various groups of assets on the site. For example, you can use a Count element to record the position of manholes or count the number of trees.

The properties that are exposed for the Count element are summarised below.

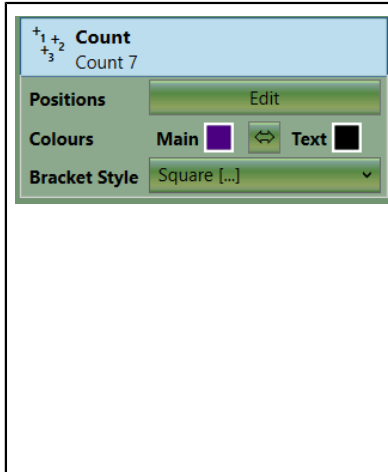

- **Positions**

The Positions Edit button provides access to the editor where Points can be added/edited for the Count.

- **Colours**

Here, you can set the Main and Text colour of the Count element. This can be useful for visually separating different Count measurements or making them easier to see against the colours of the topography.

- **Bracket Style**

The bracket style allows you to change the style of the brackets enclosing the item number. This can also be used to visually separate different Count measurements in your project. You can set the bracket style to 'none' if you want to show the number without brackets.



The video [Count, Length and Area Measurements](#) explains the 'Count' measurement element, illustrating point placement and discussing the value of these measurements.

## Length Element

The Length element allows you to measure distances on the site as well as record assets that have a length property such as kerbs and fences.

The properties that are exposed for the length element are summarised below.

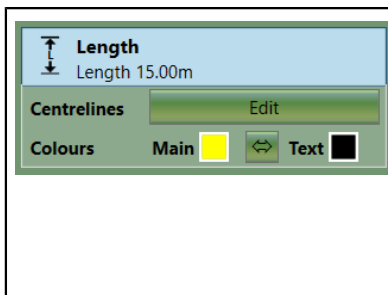

- **Centrelines**

Centrelines button provides access to the editor where definition points can be defined for the centrelines which define the length.

- **Colours**

Here you can set the Main and Text colour of the Length. This can be useful for visually separating different Length measurements or making them easier to see against the colours of the topography.



The video [Count, Length and Area Measurements](#) explains the 'Length' measurement element, demonstrating how to measure between two positions.

## Area Element

The Area element is used for measuring areas in the project. Areas of earthworks disturbance are recorded in the earthworks estimation summary so there is no need to measure these. Area elements only measure 2D areas, as if they were measured from a paper plan. They don't measure the 3D surface area that can be found in the earthworks estimation report.

The properties that are exposed for the area element are summarised below.

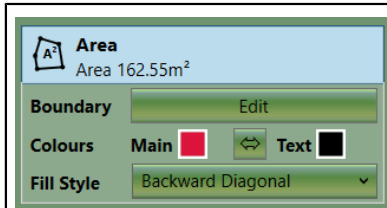

- **Boundary**

The Boundary Edit button provides access to the editor where definition points can be defined for the outline, which defines the area perimeter.

- **Colours**

Here you can set the Main and Text colour of the area element. This can be useful for visually separating different Area measurements or making them easier to see against the colours of the topography.

- **Fill Style**

The fill style allows you to fill in the area with different styles of hatching. This can also be used to visually separate different Area measurements in your project. You can set the fill style to none if you only want to see the boundary lines of the measurement.



The video [Count, Length and Area Measurements](#) explains the 'Area' measurement, covering how to draw the boundary and use colour hatching for clarity.

## Volume Region Element

The Volume Region element is used for reporting cut/fill in different regions of a particular phase. It is important to note that there is no requirement to have Volume Regions defined in a phase. If none are defined, the 'Estimation' report will still display a breakdown by element and results for all earthworks in the phase.

Intersecting regions are not allowed. This is to prevent potential confusion caused by cut/fill volumes being counted multiple times in the same breakdown. Handling a region within a region involves first calculating the outer region excluding the inner region and then separately calculating the inner region. Any areas not enclosed by a region will be listed under 'remainder'.

The properties exposed for the region element are summarised below.

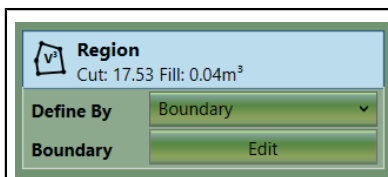

- **Define By**

Dropdown options to choose how to define your region are:

- **Boundary** (default)
- **Cut and Fill Range**
  - Height (enter value)
  - Depth (enter value)
- **Cut Range**
  - Lower Depth (enter value of least cut)
  - Upper Depth (enter value of most cut)
- **Fill Range**
  - Upper Height (enter value of most fill)
  - Lower Height (enter value of least fill)
- **Boundary**

The Boundary Edit button provides access to the editor where definition points can be specified for the outline, which defines the Volume Region.



The [Volume Region Measurements](#) video demonstrates how to draw valid volume regions and explains how they are reported in the spreadsheet export (pre 2024).

## Volume Region - Batch Create

There are two established groupings of excavation/earthworks estimation ranges in *Kubla Cubed*. Currently, the program supports two Royal Institution of Chartered Surveyors (RICS) standards: NRM2 and SMM7. To create a standard batch of volume regions in a phase of your project, follow these steps:

1. Double-click on 'Measurements' to open the [panel](#).
2. Click the '+' button and hover your cursor to reveal the 'Batch Create' button and click.
3. Select the standard you wish to use.

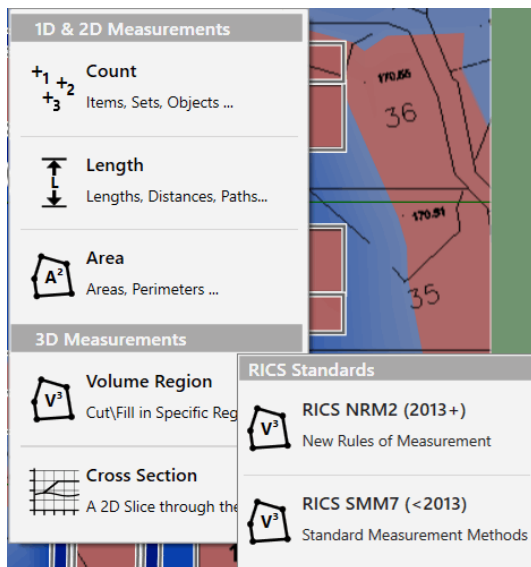

## RICS NRM2 (2013+)

### NRM2 - New Rules of Measurement

Use this tool to create Volume Region reports specified in NRM2 for different types of excavation and filling.

- By default, 'Excavation' and 'Filling obtained from excavated materials' are selected.
- Select the options you require volumes for and click OK.

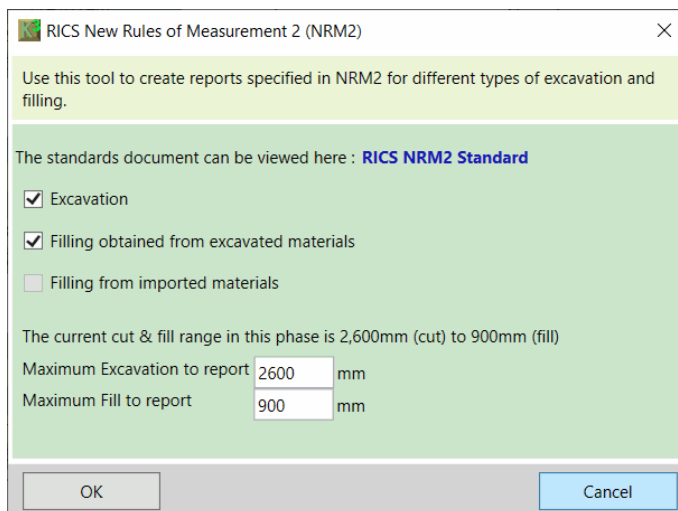

- The regions will automatically generate with the results showing in the Measurements panel on the right-hand side and the regions defined on the model with an orange and black dashed boundary (as shown in the image below).

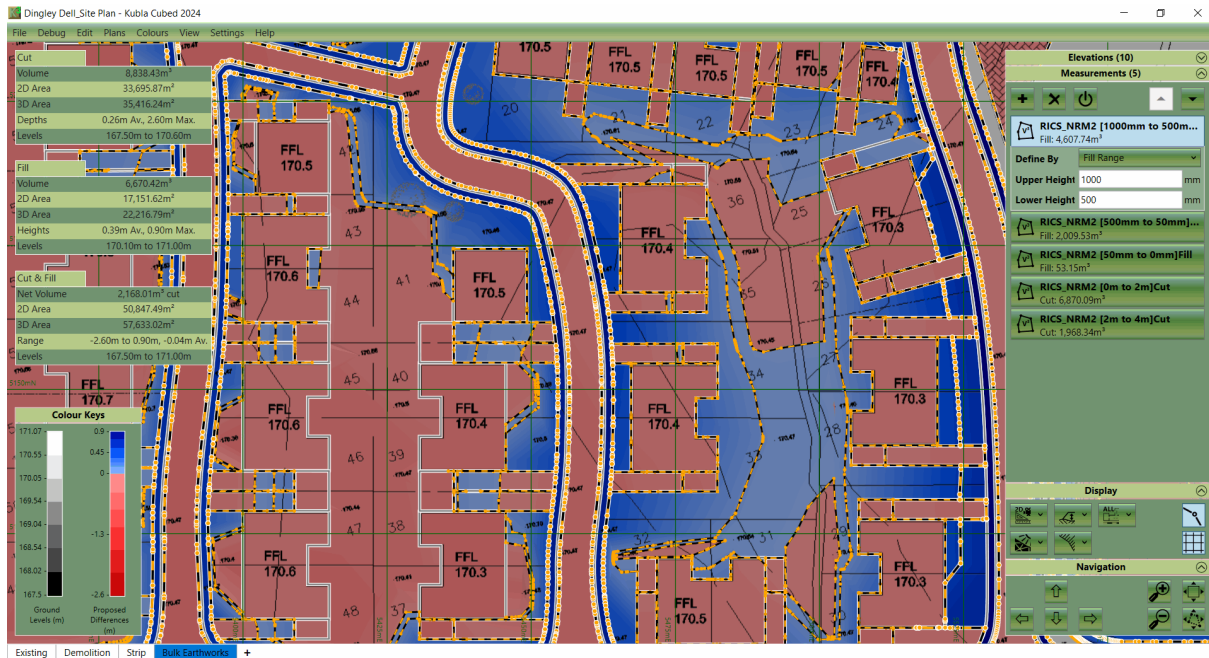

## RICS SMM7 (< 2013)

### SMM7 - Standard Measurement Methods

Use this tool to create Volume Region reports specified in SMM7 for different tups of excavation and filling.

- By default, only 'Excavation' is ticked.

The screenshot shows the 'RICS Standard Methods of Measurement 7 (SMM7)' dialog box. The title bar reads 'RICS Standard Methods of Measurement 7 (SMM7)'. The main text says 'Use this tool to create reports specified in SMM7 for different types of excavation and filling.' Below this, there are two checkboxes: 'Excavation' (checked) and 'Filling' (unchecked). A text box below the checkboxes states 'The current cut & fill range in this phase is 2,600mm (cut) to 900mm (fill)'. Below this, there is a text box for 'Maximum Excavation to report' with the value '2600' and the unit 'mm'. At the bottom of the dialog box, there are 'OK' and 'Cancel' buttons.

- If you attempt to tick 'Filling' you will receive a pop-up message with the SMM7 guidelines and four options to choose from. The message states:

SMM7 guidelines state that fill should be reported by 'average fill'. An average fill calculation requires a defined area, so this calculation can only be completed if the site has been rationalised into discrete areas (e.g., planting boxes, grid cells, phases of work, etc.).

### Average Fill Solutions (SMM7 Guidelines)

This tool cannot be used to report by 'average fill'. However, there are several approaches that could be taken to report average fill using tools available in Kubla Cubed:

- [1] The element breakdown can give you an average fill of the element reporting areas.

[2] You can manually trace volume regions to get an average fill in custom areas.

[3] Export to a grid and calculate average fills in each grid cell manually and sum cells accordingly.

### Depth Band Solution (Not to SMM7 Guidelines)

[4] Alternatively, Kubla Cubed can report by depth bands in a similar way to SMM7 excavation and NRM2 Cut & Fill. However, it should be noted that this does not adhere to the standards specified in the guidelines for SMM7 Fill.

- When you choose option [4], 'Filling' will be ticked, then click 'OK' to generate the regions.

## Validation Failed

When two or more Volume Regions overlap, they will all be invalid. This is displayed in *Kubla Cubed* by the element being highlighted in Red, with an error message of 'Validation Failed' written in the metadata field. No volumes are calculated or reported for the regions that have this status.

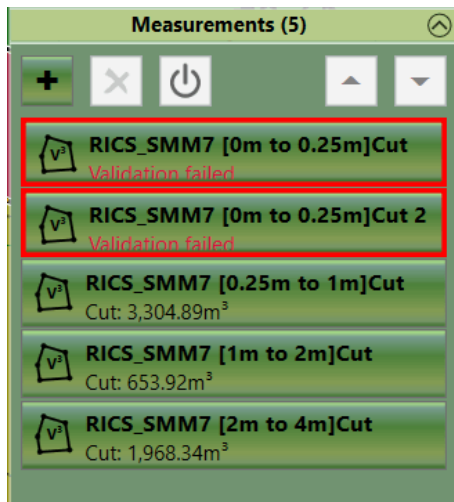

The valid measurements will still show in the [The Measurements Panel](#) on page 66 and on the export reports/spreadsheets. The errored element(s) will not be reported. To rectify this error, either disable one of the elements that has a duplicate region or delete it completely.

## Cross Section Element

The Cross Section element is used for visualising a slice cut through the terrain, and displaying both the existing and the proposed layers. The Cross Section can be viewed in the software, and also will be presented in exports.

The properties that are exposed for the Cross Section element are summarised below.

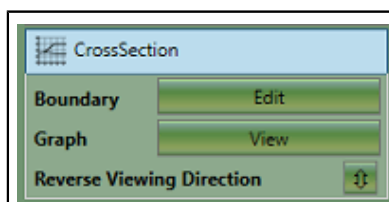

- **Centrelines**

The Boundary Edit button provides access to the editor where the definition points can be defined for the points which define the cross section.

- **Graph**

Click the View button to display the cross section graph.

- **Reverse Direction**

The direction that the cross section is viewing will be indicated by the section arrows on the screen. You can reverse the direction by clicking this button.

When you click on the 'View' button, a screen will open, similar to the one shown below. You can use the mouse to zoom in and out and pan around this section. As you move the mouse, the cursor will present the levels, and the cut/fill information. It is worth noting that the sections presented in this view will use the [vertical exaggeration](#) from the main window. If you find the section difficult to visualise because it is too flat, you can increase the vertical exaggeration before viewing the section.

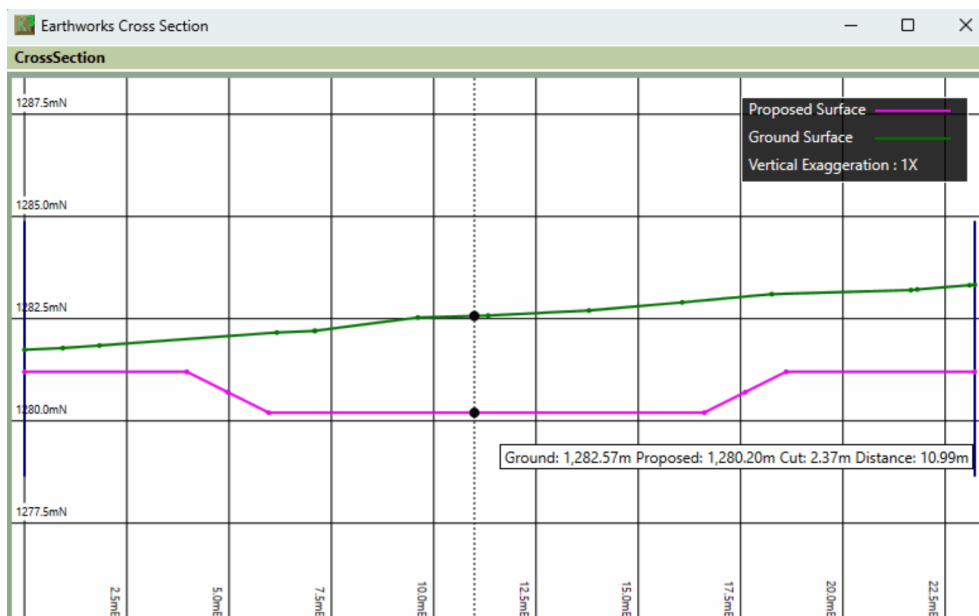

[Measurements - Cross Sections](#) demonstrates drawing long sections and cross sections across a phase, before highlighting various viewing and export options.





---

# Chapter

# 8

---

## Editing Elements

---

### Topics:

- [Feature Types](#)
- [Adding New Features](#)
- [Adding Features Manually](#)
- [Adding Features from a PDF/ CAD File](#)
- [Adding Points from a Data File](#)
- [Editing and Deleting Features](#)
- [Group Selection](#)
- [Editing Tools](#)
- [Copy and Paste](#)
- [Triangle Surface](#)





**NOTE:** Elements can be edited in Pop-In or Pop-Out mode. For an explanation of these modes see [Editing Modes](#).

With the exception of the Triangle Surface, all elements are defined by a collection of elevation features, drawn manually or loaded from a file (e.g. CAD). The four elevation features are: outlines, contour-lines, break-lines, survey-points, or a combination but always in that order.

After an introduction to the feature types (outlines, contours, breaks and points) the remainder of the chapter covers how to import data, create it manually and also update/edit.

## Feature Types

The elevation features may be named differently within some elements, however they have the same behaviours and are recognisable by their icon and order. The feature surface has all four types of data, which makes it suitable as a base example. Any combination of the following terrain features (where available) can be used to define the terrain:

	<p><b>Outlines</b></p> <p>This element is used to define the outline(s) of the feature surface. There will almost always be only one outline, but it is possible to define more than one to create several 'islands' of terrain. It is also possible to create holes in the terrain by adding internal outlines.</p> <p>There are also different types of Outline:</p> <ul style="list-style-type: none"> <li>• <i>i) Extrapolate from other Features (Default):</i> Takes the levels from contained elevation features that you have defined (e.g. contour lines and points).</li> <li>• <i>ii) Define Varying Levels:</i> Allows you to set levels for the outline which vary at each point. This can be used if you need maximum control of the surface outline elevations.</li> <li>• <i>iii) Define Fixed Level:</i> Allows you to set a single level for the outline, this is only used in very unique scenarios.</li> <li>• <i>iv) Use Ground Levels:</i> Snaps the Outline elevations to the ground. (This can only be used with a feature surface used to define proposed earthworks)</li> </ul>
	<p><b>Contour Lines</b></p> <p>Contour lines (or isolines) are used to define lines on the terrain with a fixed elevation</p>
	<p><b>Break Lines</b></p> <p>Break lines are used to defined lines on the terrain which have a varying elevation</p>
	<p><b>Point Levels</b></p> <p>Point levels are used to define the levels for individual points in the terrain area</p>

The properties of each feature vary depending on the feature type, but they all have a 'Tag' which can optionally be set. This is an identifier for the feature (akin to the feature's name), and it is used to help the user identify particular features.

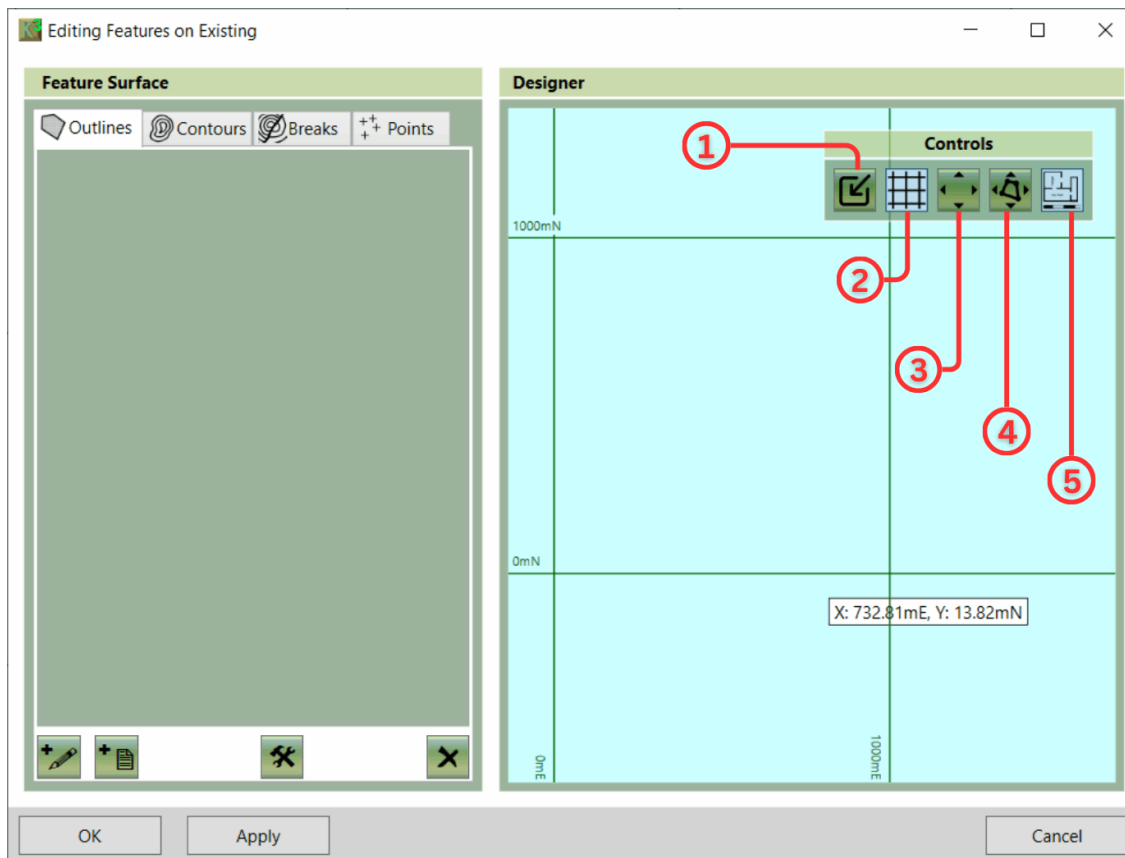

This form includes three display buttons as described below:

- ① Pop in to Edit in Main Window This takes you back to the main editing and model window.
- ② Toggle Grid This button toggles the grid in the designer on and off.
- ③ Zoom to Extents This button zooms the designer to extents (i.e. frames all elements in the designer panel)
- ④ Zoom to Selection This button zooms the designer to selected features
- ⑤ Toggle Site Plan This button toggles the site plan in the designer on and off.

The rest of the controls on this form are used to add, remove and edit the terrain features. They are described in detail in the following sections.



Learn to define boundary outlines in the video [Understanding Feature Surface Outlines](#).

## Adding New Features

Terrain features can be added either by drawing them manually on the designer screen or by loading them in from a file. Outlines, Contour Lines and Break Lines can be loaded from PDFs (with vector data) and CAD files (.dwg, .dxf) whereas Point Levels can be loaded from either a PDF (with vector data) CAD, or from an Excel or text data file.

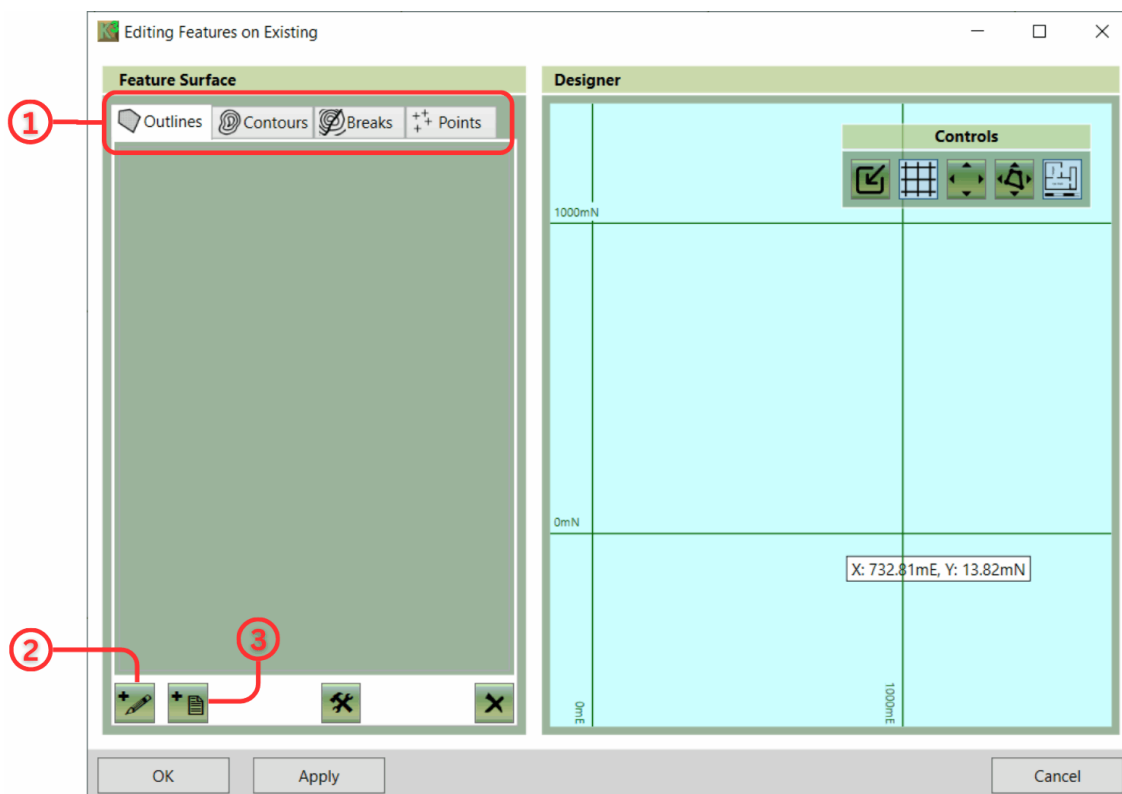

To add a new feature, select the feature type that you want to create ① and then click either Add Manually ② or Add from File ③. If you add a feature from a file you will be prompted to select the file to open. The process to follow after this is described in the following sections.

## Adding Features Manually

The process, once you have clicked on the + button to add a new feature manually, depends on the type of feature you have selected. In all cases, you draw the elements on the designer panel on the right of the screen.

- **Outlines**

When you choose to add an Outline, the following prompt will appear, providing two options to create outlines.

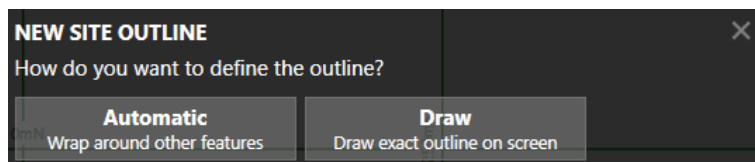

- **Automatic outline:** If you choose this option, the software will automatically create outlines based on the features that you have defined. This process is analogous to wrapping a rubber band around the features that

you have already defined to create an outline. You can adjust how much this 'rubber band' is 'sucked in' using the tolerance slider bar.

- **Draw:** If you choose this option, you will draw an exact outline on the screen. You will be provided with a four options to set the levels for this outline:
  1. *Extrapolate from other Features (Default):* Takes the levels from nearby elevation features that you have defined (e.g., contour lines and points).
  2. *Define Varying Levels:* Allows you to set levels for the outline that vary at each point. This can be used if you need maximum control of the surface outline elevations.
  3. *Define Fixed Level:* Allows you to set a single level for the outline; this is only used in very unique scenarios.
  4. *Use Ground Levels:* Snaps the outline elevations to the ground (this can only be used with a Feature Surface used to define proposed earthworks).

When you choose your preferred option, follow the steps to complete the outline. Once you have finished, you will see the prompt below.

You can define a Tag for the Outline if you wish. Click 'Next' to draw another Outline, or 'Finish' to stop drawing Outlines.

- **Contour Lines**

Draw each point of the Contour Line by left-clicking on the designer panel. Finish drawing the contour by right clicking or by pressing the Enter key. The following prompt will appear:

You should type the level for the Contour Line into this prompt. You can also define a Tag if you wish. Lastly, if the Contour Line is a closed loop you can click the Closed checkbox. Click Next to draw another Contour Line or Finish to stop drawing Contour Lines. Note that the '...' before the 'Level' input box can be used to adjust the levels you type. E.g. if all of your levels start from an elevation of 1000 you can click on '...' and input '1000+'. You can then type, for example '26' into levels box and this will be converted into '1026'. This can save time in some take-off scenarios.

- **Break Lines**

When you choose to add a break line, you will be prompted to click on the designer panel to define the first point's position. Once you have done this you will see the following prompt.

You can define a level (Z) for the Break Line point and can also type precise X and Y values if you wish. If you prefer, you can skip typing the level, and the software will interpolate it. This is useful if you have a detailed break shape where the levels are only defined at a few locations.

If you leave point levels blank, the software will fill them in with the following logic:

- Wherever the Break Line crosses another line (e.g., a contour) a point will be added to the Break Line with the same level as the crossing line.
- When crossing line points have been added, linear interpolation will be used along the Break Line to fill in any missing levels.

Click 'Continue' to draw another breakline point or 'Complete' to finish drawing the Break Line. Once you have finished drawing a Break Line, the following prompt will appear:

You can also define a Tag for the new Break Line if you wish. If the Break Line is a closed loop you can click the Closed checkbox. Click 'Next' to draw another Break Line or 'Finish' to stop drawing Break Lines.

- **Point Levels**

Draw the Point Level by left-clicking on the designer panel. The following prompt will appear:

You should type the level for the Point Level into this prompt. You can also type X and Y values for precise positioning. If you wish, you can type a Tag for the Point Level. Click 'Next' to draw another Point Level or 'Finish' to stop drawing Point Levels. Note the comment on 'Contour Lines' above regarding the '...' in front of the level input box.

## Adding Features from a PDF/CAD File

---

To extract vector data from a CAD.PDF file in *Kubla Cubed*:

### 1. Adding the PDF/CAD File as a Site Plan:

- Open *Kubla Cubed* and navigate to Plans → Add PDF File (.pdf) or Add CAD File (.dwg, .dxf).
- Choose the desired PDF/CAD file and click 'Open'.

## 2. Scaling and Positioning the PDF File:

- Since PDFs are in printer space, you must scale and position the file as required.
- Use the *Kubla Cubed* tools to adjust the scale and position of the PDF accurately. See [Setting the Position and Cropping](#).
- CAD files are usually scaled; however, a quick scale check by holding down the 'M' button is recommended. See [Quick Measure Tool](#).

## 3. Selecting Elements and Adding Features:

- Click + button in Elevations and select elevation element type you wish to add.
- Choose the feature tab (Outlines, Contours, Breaks, Points) for importing.
- Click the 'Add from File' button located at the bottom-left of the editor panel.
- Select the embedded PDF file you previously added as a site plan.

Upon selecting a CAD (.dxf, .dwg) file or vector PDF, a "Load.." pop-up window will appear (shown below).

Please note that this window will exclusively extract features interpretable as the selected feature type, as follows:

- **Outlines:** Only closed lines will be displayed
- **Contour Lines:** Only lines will be displayed
- **Break Lines:** Only lines will be displayed
- **Points:** Only points will be displayed
- **Centre Lines:** Only lines will be displayed

## 4. Importing Entities:

- A new "Load..." window will open, click 'New Filter' ①.

The CAD importer allows multiple selection filters. This means that if you have major and minor contours you can have a filter for each rather than combined. Instead of filtering red and green lines with a width of 1 or 3, you can filter red lines with a width of 1 and green lines with a width of 3. This allows for more precise filtering.

- Position the cursor in the Original window ⑦, left-click to start and finish highlighting the element you wish to import.
- The selected lines/points will display in the 'Extracted' window ⑧. The number of points extracted displays in grey and the if there are points/lines with no defined value the count will show in red.

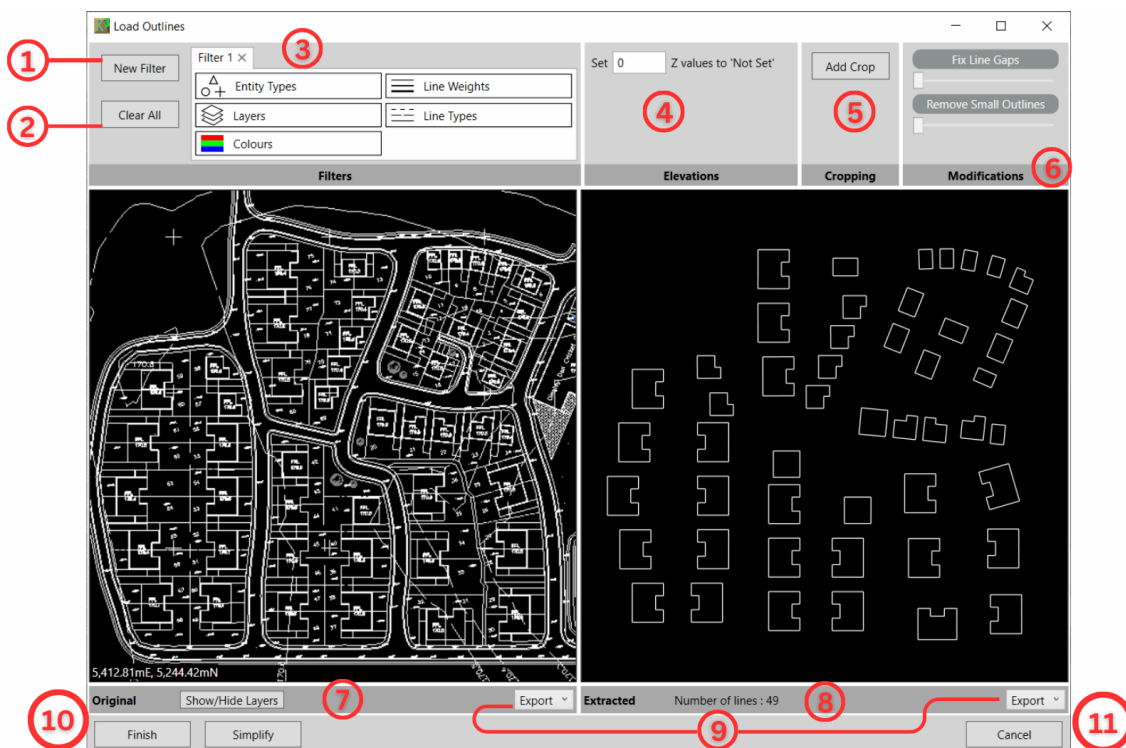

## 5. Inspecting and Filtering Options:

- ③ Filter: Inspect and filter entities in the site plan file by clicking on the Layers, Entity Types, Line, Weights, Line Types and Colours. Toggle on/off as needed; turned-off Layers etc. will not be imported.
- ④ Elevations: for setting elevations in CAD to a proxy 'Not Set' value (e.g -9999 or 0) which will then be converted to 'Not Set' when imported into Kubla Cubed.
- ⑤ Cropping: Only want to extract part of a site plan? Crop an area in the Original window to remove any unwanted data.
- ⑥ Modifications: Adjust the sliders to remove small outlines/lines and fix line gaps in the extracted data.
- ⑦ Show/Hide Layers: Click to see a list of layers in the file. Toggle on/off to show/hide the layers you require. This makes locating a specific layer easier to find.
- ⑨ Export: Export the original file as a CAD file or Export the extracted data as either CAD or CSV.
- ⑩ Simplify: With large data sets, you can opt to reduce the detail by clicking the simplify button and adjusting the tolerance slider in the pop-out window.
- ⑩ Finish: Click once ready to import the data showing in the extracted window. This will close the window and show the data in the model view.
- # Cancel: Click to close the window without importing data.

## 6. Editing Entities in the Model View

After clicking Finish in the 'Load...' window, your entities will import into the Kubla Cubed model window where you can edit further.

- Outlines, Contours, and Break lines can be edited using tools found in the Tool Menu (Hammer/Spanner).
- Use these tools for Joining, Splitting, Setting Multiple Elevations, and Ordering features. Refer to [Editing Tools](#) on page 88 for details.





Learn to import contours, points, and a poly-face mesh in our [Working with CAD Data \(.dxf, .dwg, .dgn\)](#) video, which also covers CAD export.

## Adding Points from a Data File

Once you have selected an excel or text file the following window will appear. In the case of an excel file, the 'File Format' section will not appear, as this is only used for defining text file formats.

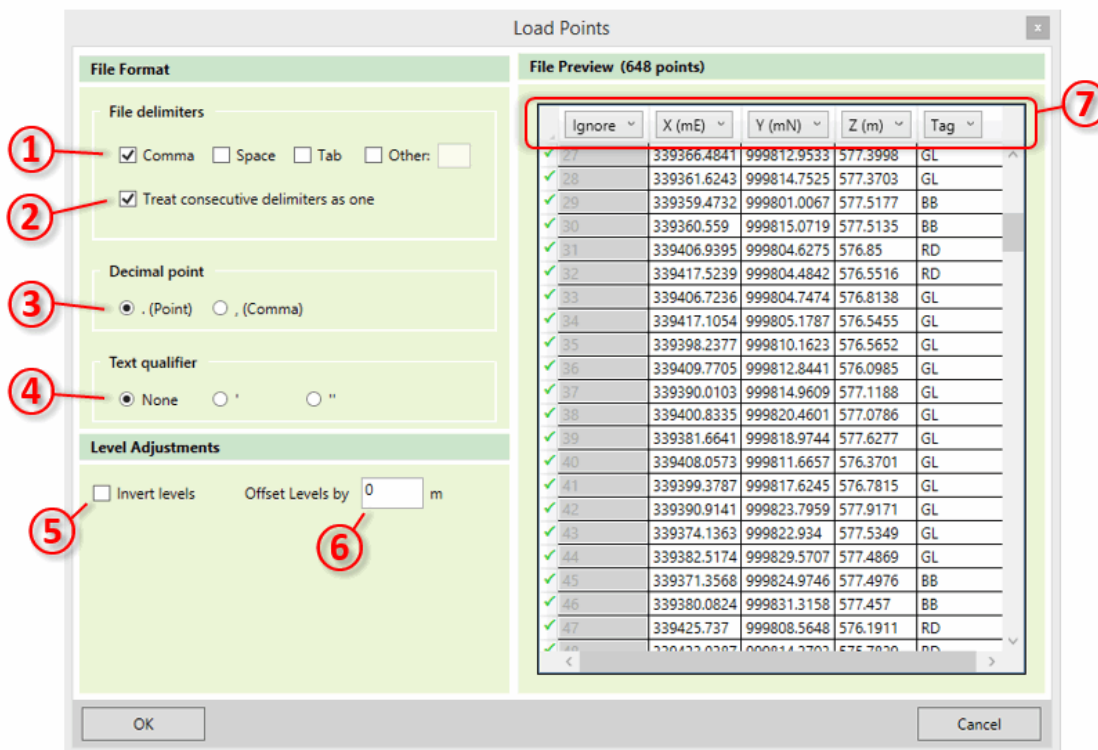

If you are using a text file it is necessary to define the file format with the controls on the left. In many cases the file will immediately show correctly in the previewer. However, if you have an unusual file format you may need to amend the details of the file format on the right side as follows:

- ① File delimiters Specify what character is used to delimit the fields in your file. Files are typically tab, comma or space delimited, but any character can be specified here by clicking Other and typing in the text box.
- ② Treat consecutive delimiters as one Specify whether several consecutive delimiters in a file line should be treated as one, or if these should be treated as several fields with empty values.
- ③ Decimal Point Specifies whether your file uses a point or a comma to denote a decimal point. This is used to deal with different conventions in different parts of the world.
- ④ Text Qualifier Specifies the character that is used on either side of a text field in the file, if your file contains text fields.

There are also some controls which can be used to adjust the levels (Z values) in the file:

- ⑤ Offset Levels by - If the points in your file are offset from the vertical datum you want to use then you can specify it here.

- ⑥ Invert Levels - *Kubla Cubed* uses upwards-positive convention for levels. If your file uses upwards-negative convention, then you can use this option to invert the values in your file so that they are suitable for *Kubla Cubed*. This option is mostly used for hydrographic surveys, which often report depths as positive values.

Finally, you must specify which columns in your file represent the X, Y, Z and Tag (if it contains tags) values for the data. This is done by clicking on the column header in the data preview ⑦ and selecting 'X', 'Y', 'Z' or 'Tag' from the drop-down. You can also specify 'Ignore' if that column contains data which is not relevant.



In the video [Kubla Cubed Tutorial | Importing Point Files \(.xyz, .csv, .xls\)](#) we look at importing point files to define both the existing and proposed terrain using a feature surface.

## Editing and Deleting Features

Features can be selected in two ways - either by clicking the element on the list to the left of the window or by clicking on the feature in the designer panel. Note that only the current feature type is selectable in the designer panel. For example, in the example shown below only contour lines ① are selectable in the designer panel. See [Group Selection](#) for more information.

Once features have been selected, they can be deleted by clicking on the Delete ② button.

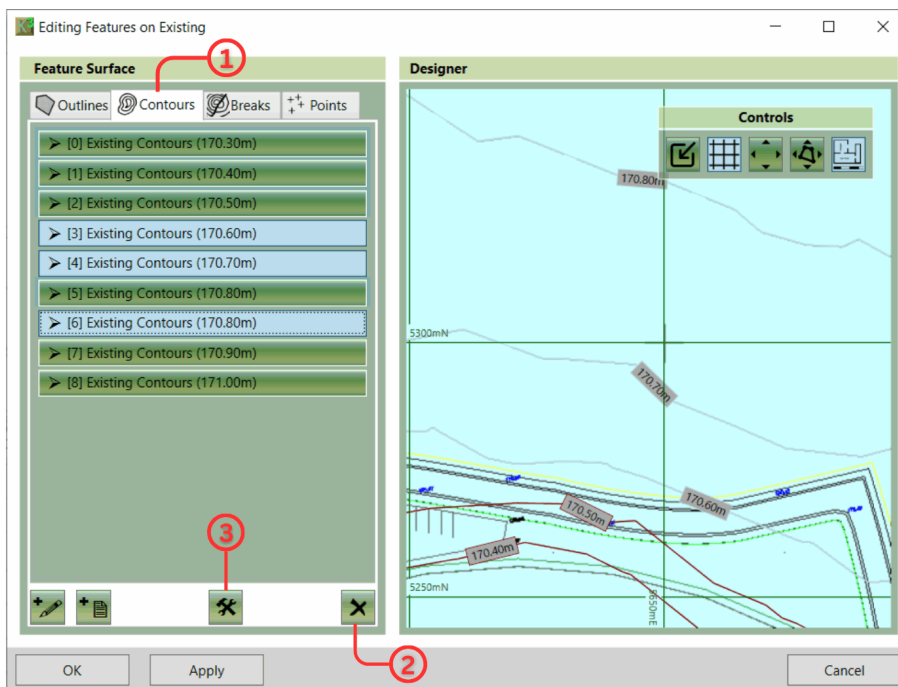

There are additional tools: Join, Split, Offset, Set Multiple Elevations, Sort, which can be found when selecting the Tools ③ button. Find out more in [Editing Tools](#).

A feature can be edited by double-clicking on it in the sidebar or designer panel. When you do this, the feature will be expanded in the sidebar, exposing its properties so that you can change them. You can now edit this feature either by typing new values into the side panel or by dragging points and lines in the designer panel ②. Points can be added to or removed from lines by clicking on the ± button in the table ①. You can also add a new point to split a section of a line, by selecting the section and clicking Z.

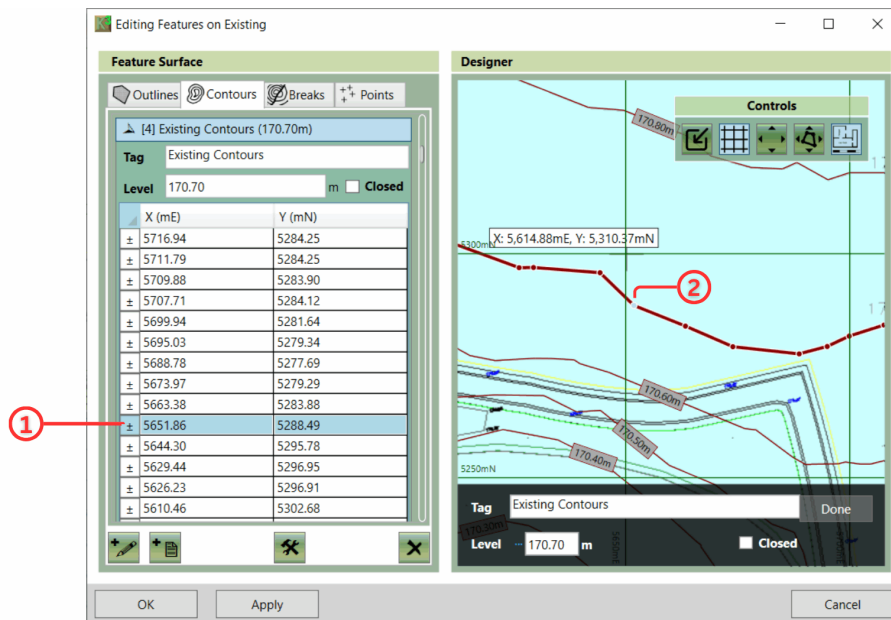

## Group Selection

Being able to select multiple features at the same time speeds up editing. The below images show two methods of group selection.

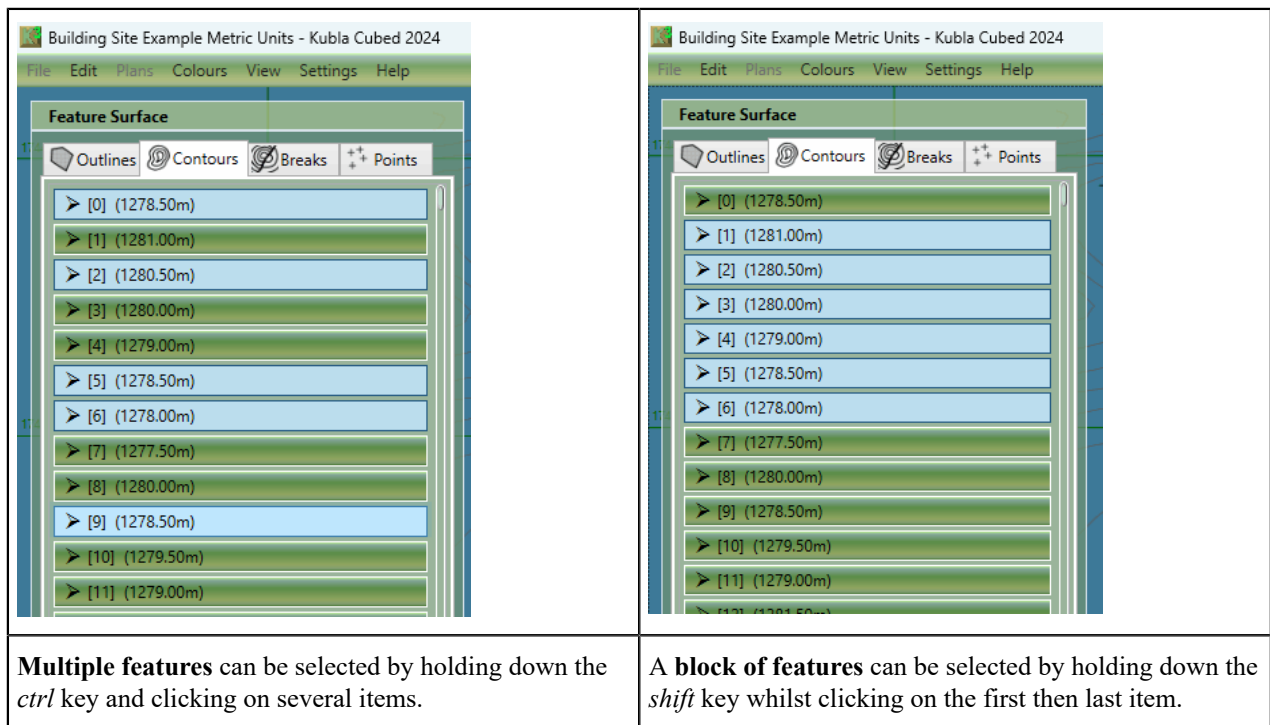

Click your left-mouse button on a single feature, without pressing a key, to deselect all other features.

## Editing Tools

Line editing tools—[Join](#), [Split](#), [Offset](#), [Set Multiple Elevations](#), and [Sort](#)—assist with the definition of lines. Availability is dependent on the element being edited and the type of feature used within. They are accessible from the Tools menu (shown below) within the element editor.

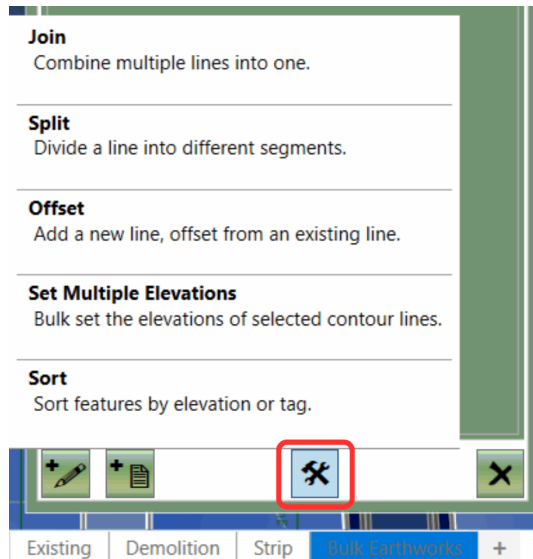

### Join Tool

The Join Tool can connect two or more contour break-type lines together and supports the joining multiple elevation features in one operation. This functionality is useful for fixing contour line gaps, such as text labels imported from a CAD file. When working with contour lines, and more than one elevation is included within the selection, the tool defaults to choosing the highest elevation, alternatively this value can be edited as needed.

#### How to use the Join Tool

Once your lines have been added (whether through imported data from a file or drawn manually), the process involves selecting the lines that need to be connected, previewing the planned join, and then confirming the operation.

	<ol style="list-style-type: none"> <li>1. Select the Join tool from the Tools menu.</li> <li>2. Choose the lines you wish to be joined.       <ol style="list-style-type: none"> <li>a. Click on the first line you wish to join.</li> <li>b. Hold down the Ctrl key and select the second (and subsequent) lines which you want to merge into one line.</li> </ol> </li> <li>3. Press the 'Continue' button when ready to proceed.</li> <li>4. Verify that the preview is indeed what you want (the lines will be joined and highlighted in green)</li> <li>5. Review and adjust the level (contour type lines only) and edit as needed.</li> <li>6. Press the 'Finish' button</li> </ol>
--	--

*Join tool in preview; inset the join tool selected as found in the tools menu.*

#### Why won't my lines join?

If only one line is selected, or if one or more of the lines are closed, the join operation will fail, and the validator will display an error message identifying the issue. This is recoverable once the necessary selection changes have been made; there is no need to restart the process. If the operation needs to be canceled, clicking on the 'X' in the top right of the black strip along the bottom will cancel the Join operation.



See the Join tool in action in our quick tip video [Join Two Lines](#).

## Split Tool

The Split Tool can divide a break-line or contour line into multiple lines, either at selected points or selected sections. This functionality is particularly useful for editing lines that may have been incorrectly joined. When a segment is chosen within the line to be split, the new lines generated will exclude the selection. Alternatively, when a point is selected within the line to be split, the newly created lines will both have an end point at the split point.

### How to use the Split Tool

After the lines have been added (via imported data file or drawn manually) select the line you want to split. This can be done either by selecting a line from within the feature list window or by selecting a line within the main window/model view. A preview will display each new line in a different colour. The split can be confirmed or discarded by clicking the 'Finish' button or the 'X' in the black wizard.

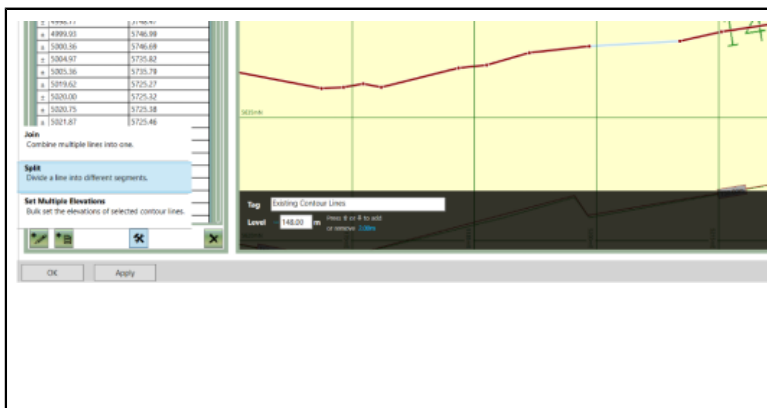

1. Select the line you wish to be split.
2. Locate and click on the point or section of the line where the split is needed (it will become highlighted).
3. Select the Split tool from the Tools menu#.
4. Press the 'Continue' button when ready to proceed.
5. Verify that the preview is indeed you want.
6. Press the 'Finish' button.

### Why won't my lines split?

Closed lines are not supported. If the line is closed, the split will fail, and the validator will display an error message identifying the issue. This is recoverable once the necessary selection change has been made; there is no need to start again. If the operation needs to be canceled, click on the 'X' in the top right of the black strip along the bottom, will cancel the Split operation.

## Offset Tool

The Offset Tool is used to create a new line placed at a user-specified offset (relative distance and relative elevation) from the original line. Users are prompted to enter a point indicating which side of the original line the offset should be placed. While the elevation represents a relative adjustment along the Z-axis, the distance relates to adjustments within the XY plane. This functionality proves particularly beneficial for generating footpaths alongside roads. The tool extends its support to outlines, contours, and break-lines.

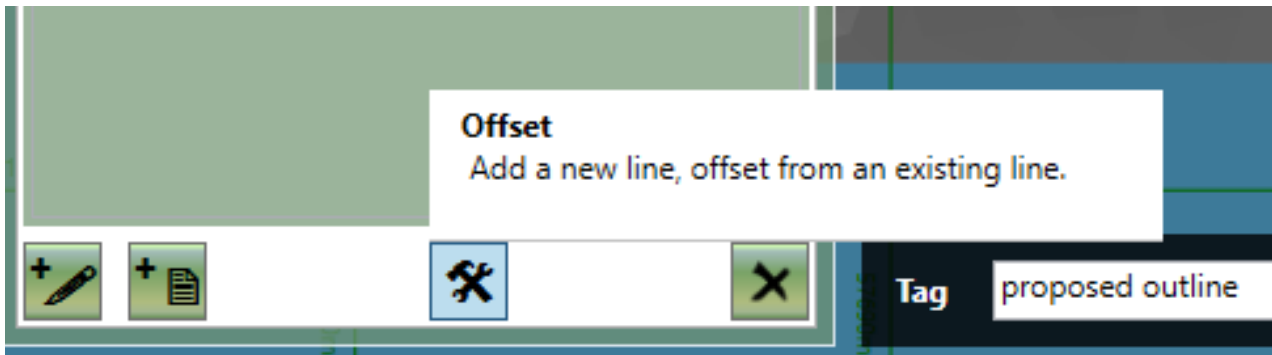

### How to use the Offset Tool

1. Begin by adding at least one original line (outline, contour or break), either through file-imported data or by drawing it manually.
2. Select the line from which you wish to create the offset, either from the feature list window or by directly clicking within the main window/model.
3. Proceed to the 'Tools' menu and select 'Offset' (see image above). Upon selection, the mouse cursor icon will transform into a crosshair, indicating the need for the user to pinpoint the side of the original line where the new offset line should be placed.

NOTE: If the single click (with crosshair) is within a closed line, the offset line will also be closed, provided the entered distance does not prevent a valid offset. In all other scenarios, the offset line will be outside the original. If the preview does not display the desired outcome, the Z adjustment and distance can be modified until the 'Finish' button is pressed.

4. Subsequently, the Wizard will prompt for the input of the relative Distance and relative Z (Z Adjustment) from the original line. For instance, if the elevation of the original contour line is 200m, a Z adjustment of 20m will set the elevation of the offset line to 220m. The distance denotes how far the new offset line will be positioned from the originally selected line.
5. Once valid data is entered into the distance and Z adjustment inputs, a preview of the new offset line will be displayed. The preview will dynamically update after each alteration to the distance or Z adjustment, Rounded Corners, and Delete Original, although it requires the user to deselect the input box for the updates to take effect.
6. Confirm the changes by pressing 'Finish'. Alternatively, discarding the offset can be achieved by pressing the 'X' in the wizard.

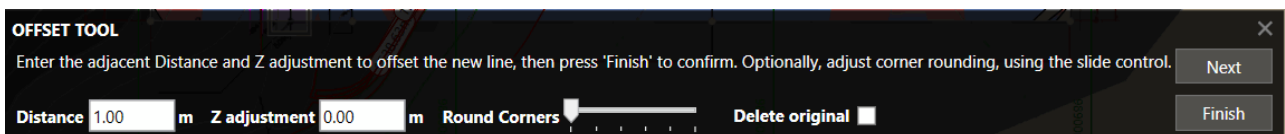

### What are Rounded Corners

Rounded Corners are useful if you want to soften corners or buildings or contours. The image below shows the original contour ①, the offset contour before rounding ② (on the left) and the offset line after the corners have been rounded ③ with the slider slid to its maximum (right).

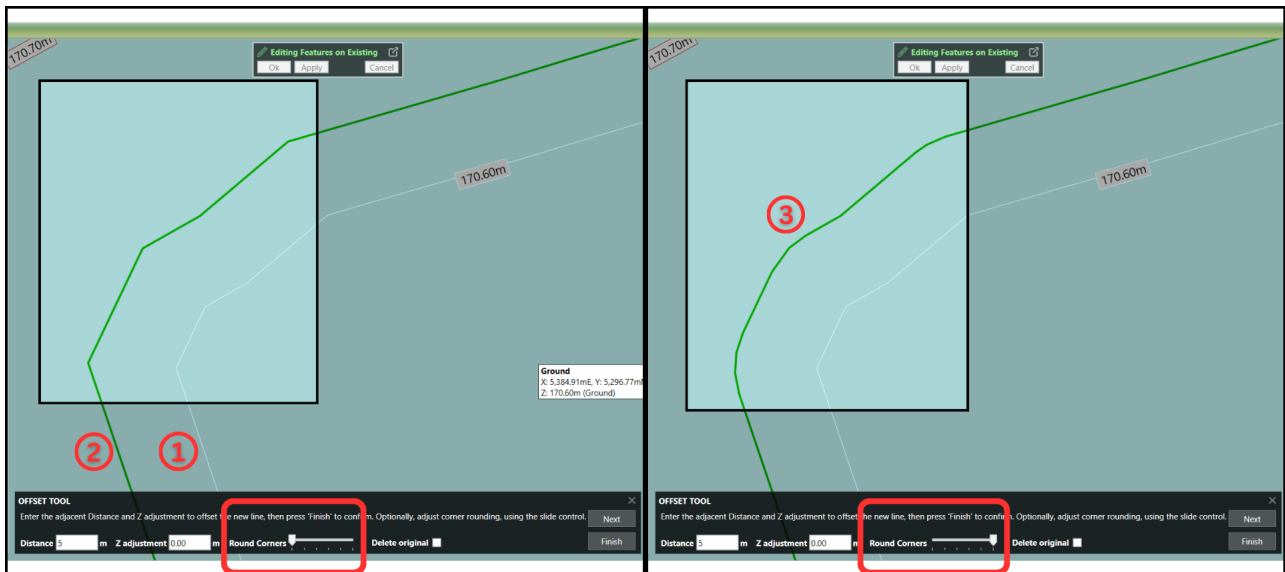

### Delete Original Line

If you only require the new line, tick 'Delete Original'. This is useful if you want an outline offset and no longer need the original line.



See the Offset tool in action in our quick tip video [Offset a Line](#).

## Set Multiple Elevation (SME) Tool

Contour lines (or isolines) are used to define lines on the terrain with a fixed elevation. When manually tracing contour lines, a fixed elevation is added after completing the line. However, when extracting contours from a PDF or importing from a flattened CAD file, there are no Z (level) values within the data; therefore, you need to add these elevations. It is acknowledged that this can be time-consuming, so the SME tool was built to set the elevations of a group of contour lines, making the process considerably faster!

### How to use the SME Tool

The SME tool works quite differently from the Join and Split tools with regards to selection. After selecting the SME tool from the Tools menu, place a point (left-click) just before the first line to be included in the range. Then, move the mouse and subsequently place a second point beyond the first and second line in the range. You can either right-click to finish or continue moving and clicking to add a multi-point line. The drawn line will identify the lines to be included.

Once the range line has been created (after right-click) the start elevation, contour interval and slope direction (ascending/descending) can be set. After editing these values as required, press 'Continue'. A preview will then highlight the contours lines with a gradient green shading to highlight the elevation differences. If the preview is acceptable, press 'Finish' to accept the proposed changes.

1. Select the SME tool from the menu.
2. Define the Range: Use your mouse's left button to draw a line from just before the first contour to the final contour, ensuring your line intersects all of the contours in the group you want to set. Lift the left button and then press it down again if you want to have a range line that is not straight. Right click to finish the line.



3. Set the 'Start' (elevation value of the first contour line e.g., 200). Then, add the 'Contour Interval' (difference between each contour e.g. 1) and choose whether the difference is ascending or descending. Click 'Continue'.
4. Review the selected lines and Press the 'Finish' button.
5. New contour elevations have been added to the list on the left-hand side and to the contours themselves.

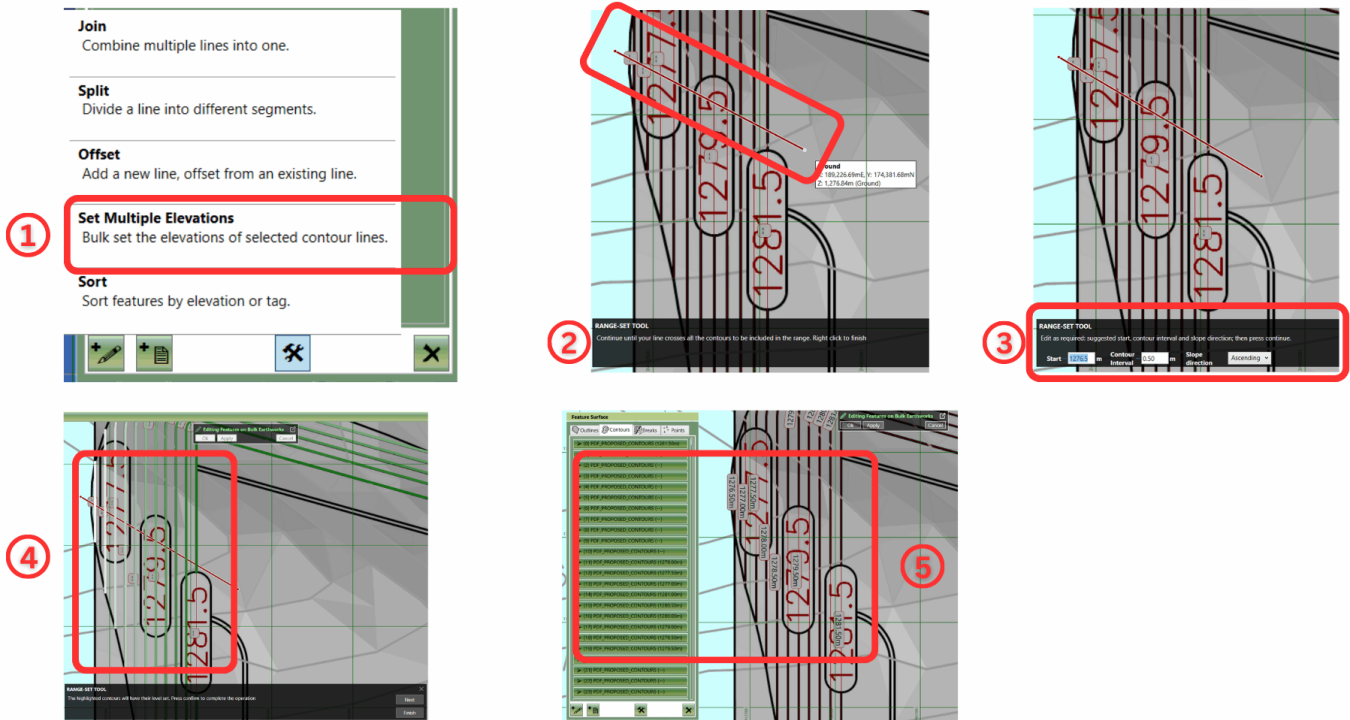

Above (clockwise from top left): SME tool location, drawing the range, accepting/editing default start elevation and interval, preview of changes.

Closed lines **are** supported. If the operation needs to be canceled, click on the 'X' in the top right of the black strip along the bottom to cancel the SME operation.

Defaults for the Starting elevation, contour interval and whether the slope is ascending/descending are set based on the first two contour lines in the selection.



The [Set Multiple Elevations \(SME\)](#) video demonstrates how to use the SME tool in *Kubla Cubed* for fast contour elevation adjustments.

## Sort Tool

When manually adding or importing features (outlines, contours etc.) to an Elevation Element (Feature Surface, Platform Reduce, etc.), they will be imported in accordance with the source file, without any specific order, such as by height. The Sort tool organises the list of features within an Elevation Element into ascending or descending order, either numerically by Elevation or alphabetically by Tag.

### Using Sort

The sort option is available by pressing the 'Tools' button when editing any element.



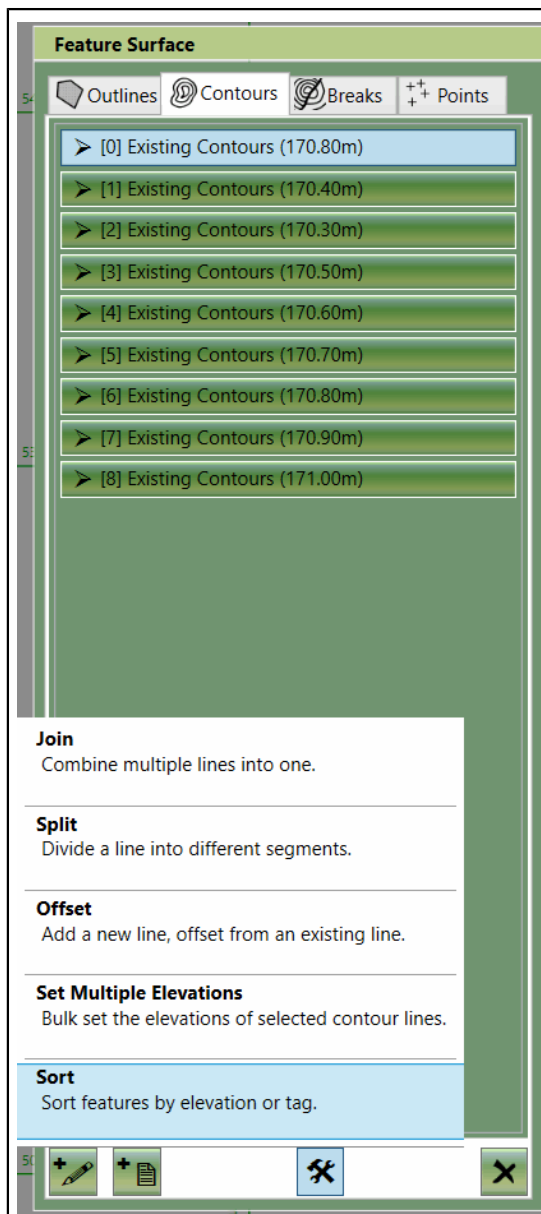

1. Select the Sort tool from the menu.

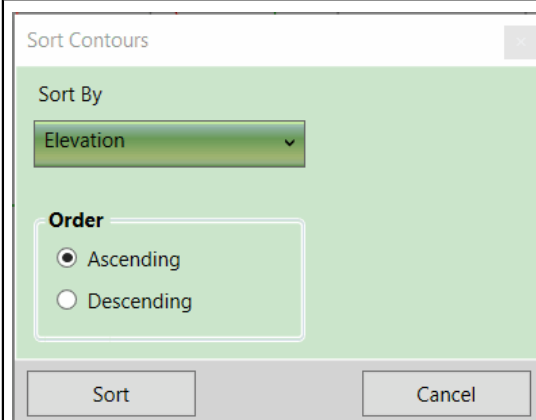

1. Select the type of sort by clicking the drop down and choosing:
  - a. Elevation
  - b. Tag
2. Select the Order type:
  - a. Ascending
  - b. Descending
3. Press 'Sort' button

The list of features will update on the left of the screen, according to the options chosen.

### Sort By Elevation

The Sort tool is useful for locating zero and 'not set' values which are interspersed in a long list of set values after importing features. For example, when ordering in ascending value, all the zero and 'not set' values will be sorted to the top of the list, or to the bottom of the list when ordering by descending value.

When ordering features with a range of elevations (e.g., feature surface break lines) in ascending order, the sorting will be based on *ascending minimum* elevation range values, whereas ordering by descending order will sort by *descending maximum* elevation range values.

### Sort by Tag

Sorting features alphabetically by Tag in ascending order will assist in finding a specific named feature within a long list. This can be useful when grouping features by tag name.

### Undo Sort

The original ordering of newly sorted features can be undone using undo (Ctrl+Z) but the sorted feature ordering will be preserved when the project is saved.

## Copy and Paste

---

It is often useful to copy and paste elements; this can be done using **Edit** menu commands or the keyboard shortcuts (**Ctrl+C**, **Ctrl+V**). You can copy and paste in the same phase to duplicate an element or copy and paste to move elements to different phases.

### Which features can you copy and paste to another?

This table shows the features you can copy and paste to another. Generally, lines can be copied to lines (as long as the "Is Closed" option is ticked) and only points can be copied to points.

Copy/Paste to:	Outlines	Break-lines	Contours	Centre-Lines	Lengths	Points
Outlines	Yes	Yes	Yes	Yes	Yes	No
Break-lines	If closed	Yes	Yes	Yes	Yes	No
Contours	If closed	Yes	Yes	Yes	Yes	No
Centre-Lines	If closed	Yes	Yes	Yes	Yes	No
Lengths	If closed	Yes	Yes	Yes	Yes	No
Points	No	No	No	No	No	Yes

## Triangle Surface

---

The triangle surface is defined by a group of interconnected triangles. You cannot define these triangles manually; instead they need to be imported from a program that works with triangulated models sometimes. The surfaces are sometimes referred to as Triangulated Irregular Networks (TIN), triangulations, polyface meshes and Digital Terrain Models (DTM).

The triangulations can be imported from CAD files (.dwg, .dxf), LandXML (.xml) files and Kubla Project files (.kcp). When importing from CAD files you need to select the layer that contains the polyface mesh objects, the polyface mesh objects in the selected layer will then all be merged together and imported as a single object. The LandXML and Kubla files work slightly differently as they do not have layers, instead you need to select the specific name of the surface you wish to import.

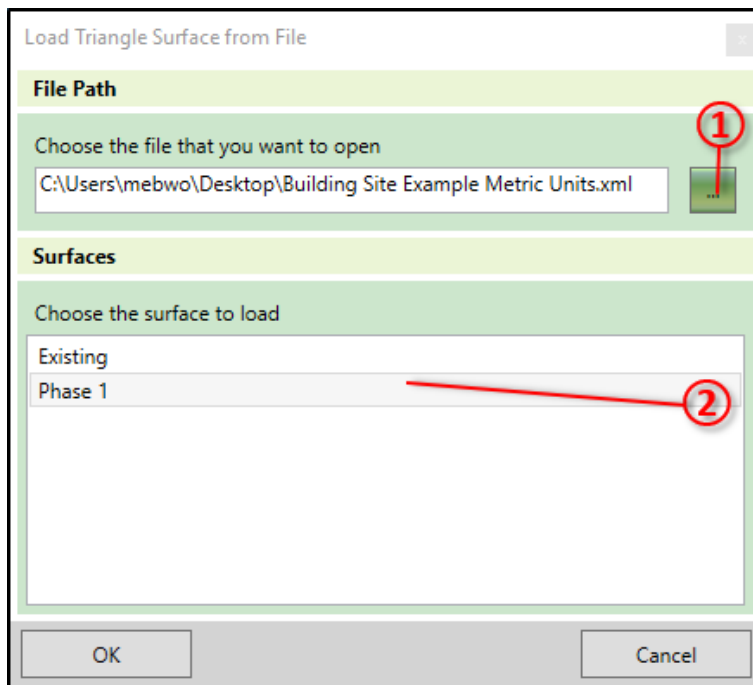

This form includes two sections:

- ① Select File Here you select the file that contains the triangulation you wish to import.
- ② Select Layer\Surface In this section you select the layer (with CAD files) or surface with LandXML and Kubla Project files.

**Note:** If you are loading from a CAD (.dwg, .dxf) file this form will also have a 'units' drop-down. This is required because the units are not saved in the .dxf format, so you need to specify them when loading the file



The video [Existing Levels - Triangle Surface](#) comprehensively covers the Triangle Surface and how to import triangle data.



---

# Chapter

# 9

---

## Defining Existing Ground

---

### Topics:

- [Existing Defined with Points, Contour Lines and Break-Lines](#)
- [Existing Defined with Triangles](#)
- [Existing Boundary Outline](#)
- [Lidar and Photogrammetry data](#)

After importing and scaling site plans (if there are any) the next stage of a cut and fill project is to define the existing ground. Existing ground can be defined from a number of different sources. A simple stockpile project may involve importing the existing ground from survey points stored in a text file; a more complicated scenario could entail extracting existing contours from an embedded PDF file's vector data. Existing take-off can be very time consuming so it is worth using CAD data or extracting data from PDF vectors if at all possible.

Existing elevations are usually defined with contour lines or points. In this scenario the feature surface can be used to define your existing. If importing from a different project that supports the creation of TINs you can also use a Triangle Surface to import a TIN directly.

## Existing Defined with Points, Contour Lines and Break-Lines

Most existing surfaces are defined by points or contour lines. Break-lines are sometimes used in the existing to define hard edges along existing buildings, roads, etc. Tracing elevations from a site plan is a workflow that has been around since the very earliest volume estimating software. Early software required input from specialist digitisers and then later with on-screen take-off. It is still possible to trace existing elevations in this way and in fact is a skill that all users need to master. However, with the right data there are much faster ways of defining existing by importing directly from files. Options for defining elevations in the existing are listed below with full descriptions following thereafter:

**Option 1:** Importing from Point Files (.xyz, .csv, .txt)

**Option 2:** Importing from CAD Files (.dwg, .dxf)

**Option 3:** Importing from PDF Vectors (.pdf)

**Option 4:** Tracing from Site Plans

### **Option 1: Importing from Point Files (.xyz, .csv, .txt):**

Point files are created during a topographic survey. They are a very simple format consisting of a text file with X,Y and Z co-ordinates separated by a special character (e.g. a comma). They can be imported into a 'Feature Surface' by selecting the 'Point' tab and selecting 'Add from File'. Using point files is very fast and accurate as the points are usually raw survey data. However, the point files do not support break-lines meaning that detail in regard to hard edges cannot be imported efficiently.

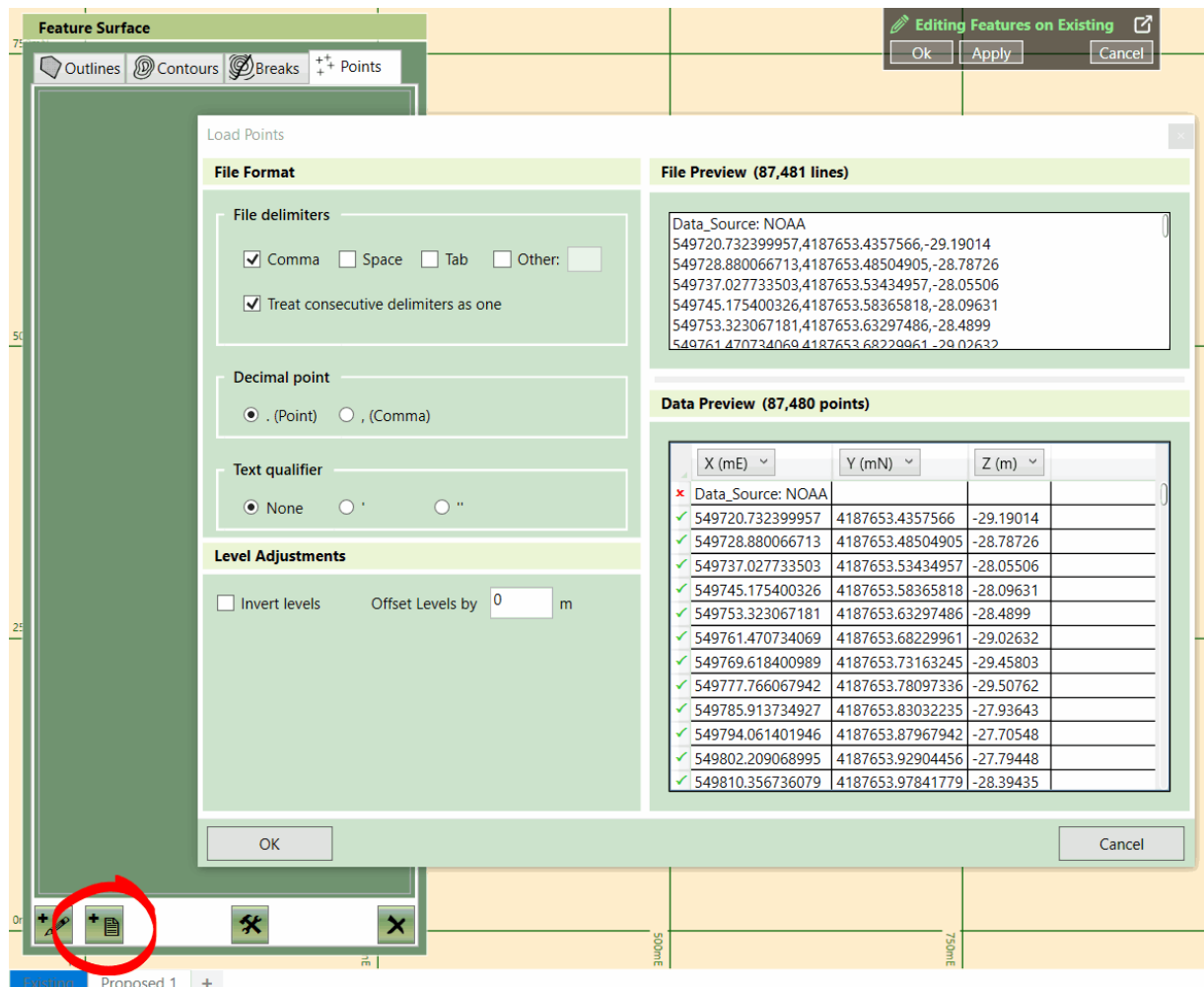

*An existing surface being created from a point file*

### **Option 2: Importing from CAD Files (.dwg, .dxf):**

CAD files can contain all the necessary data to create a detailed surface in a few clicks. They may contain points, breaks, boundary outlines and contours. Within a CAD file, you can logically separate different entities into their own layers so you can have the contours in ‘Proposed Contours’ and ‘Existing Contours’, making it easy to select what you need during the import process.

However, even though a CAD file has the potential to perfectly describe a surface with contours, points and breaks, there is no guarantee this will be the case. Various issues in a CAD file can make importing difficult. For instance, entities may be enclosed in a block, contours being represented by dashes, or entities may lack Z values, causing them to be imported at 0 (zero) elevation. *Kubla Cubed* provides tools to resolve these problems, and in general, a CAD file is usually the optimal file format to work with.

To extract vector data from a CAD file in *Kubla Cubed*:

#### **1. Adding the CAD File as a Site Plan:**

- Open *Kubla Cubed* and navigate to Plans → Add CAD File (.dwg, .dxf).
- Choose the desired CAD file and click ‘Open’.

#### **2. Scaling and Positioning the CAD File:**

- CAD files are usually scaled; however, a quick scale check by holding down the 'M' button is recommended. See [Quick Measure Tool](#).

#### **3. Selecting Elements and Adding Features:**

- Click + button in Elevations and select elevation element type you wish to add.
- Choose the feature tab (Outlines, Contours, Breaks, Points) for importing.
- Click the 'Add from File' button located at the bottom-left of the editor panel.
- Select the embedded CAD file you previously added as a site plan.

#### **4. Import Entities:**

- A new window will open, click ‘New Filter’
- Position the cursor, left-click to start and finish highlighting the element you want to import.
- The selected lines/points will display in the ‘Extracted’ window
- Use the options at the top of the window to filter the extracted data to your requirements.
- Repeat step 5 as required.
- Click 'Finish'.

For more details on the import window, see [Adding Features from a PDF/CAD File](#) on page 82

#### **5. Edit Entities**

- Outlines, Contours and Break lines, can be edited with the editing tools, found in the Tool Menu (Hammer/ Spanner), use these when you need to Join, Split, Set Multiple Elevations and Order your features. See [Editing Tools](#).

However, there are instances when processing CAD data takes so long to process it may be easier to revert to tracing from the site plans.

### **Option 3: Importing from PDF Vectors (.pdf)**

Unlike CAD files, PDF files do not contain technical metadata and are a poor option for transferring geo-technical information. However, their widespread use in the industry is due, in part, to the fact that they can be read by anyone without a CAD software product. For this reason, there is a benefit to being able to extract vector data directly from PDF files, as PDF files contain vector information. If this data can be extracted it can save a lot of time in tracing.

To extract vector data from a PDF file in *Kubla Cubed*:

### 1. Adding a PDF File as a Site Plan:

- Open *Kubla Cubed* and navigate to Plans → Add PDF File (.pdf).
- Choose the desired PDF/CAD file and click ‘Open’.

### 2. Scaling and Positioning the PDF File:

- Since PDFs are in printer space, you must scale and position the file as required.
- Use the *Kubla Cubed* tools to adjust the scale and position of the PDF accurately. See [Setting the Position and Cropping](#).

### 3. Selecting Elements and Adding Features:

- Click + button in Elevations and select elevation element type you wish to add.
- Choose the feature tab (Outlines, Contours, Breaks, Points) for importing.
- Click the 'Add from File' button located at the bottom-left of the editor panel.
- Select the embedded PDF file you previously added as a site plan.

### 4. Importing Entities:

- A new window will open, click ‘New Filter’
- Position the cursor, left-click to start and finish highlighting the element you want to import.
- The selected lines/points will display in the ‘Extracted’ window
- Use the options at the top of the window to filter the extracted data to your requirements.
- Repeat step 5 as required.

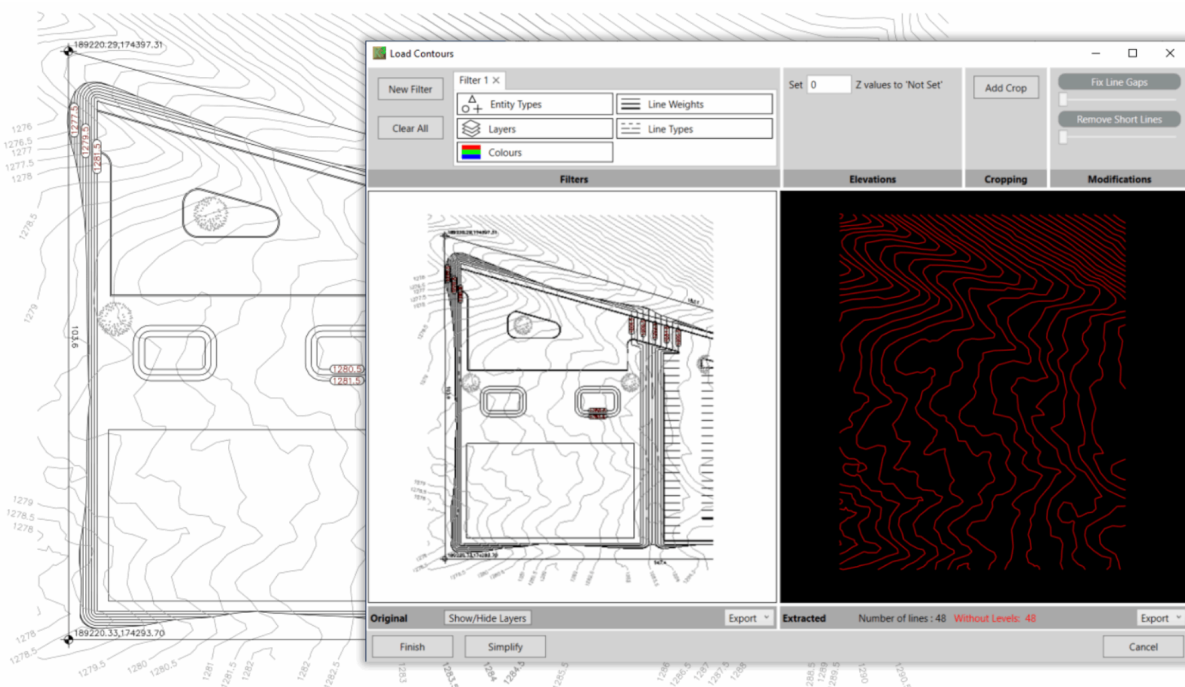

*Contour lines extracted from a vector PDF file*

For more details on the import window, see [Adding Features from a PDF/CAD File](#) on page 82

### 5. Edit Entities

- Outlines, Contours and Break lines, can be edited with the editing tools, found in the Tool Menu (Hammer/ Spanner), use these when you need to Join, Split, Set Multiple Elevations and Order your features. See [Editing Tools](#).

However, there are instances when extracting PDF vector data takes so long to process it may be easier to revert to tracing from the site plans.



#### Option 4: Tracing from Site Plans

Tracing elevation features from site plans can be very slow, however, there are some situations where there are no alternatives and so it can be used as the method of last resort. For instance, if the site plan is a very poor-quality scan or a CAD file does not contain data compatible with *Kubla Cubed's* data importer, then tracing is a good alternative.

As an estimator you can choose to be selective in regard to what data to trace. For instance, if there are many contours you could decide to only take off every other one or even just the major contours. However, this decision comes down to the estimator's judgement as to whether the increased accuracy of the extra data is worth the extra time in tracing it all.

## Existing Defined with Triangles

In *Kubla Cubed*, it is possible to define an existing surface with triangles rather than with contour lines, points, and break-lines. Typically, you would do this if you had used another piece of software to define a TIN surface already and don't want to have to define the surface again in *Kubla Cubed*. You can also export TINs of any phase of *Kubla Cubed* to define as an existing surface of a new project. This allows you to break up very large projects or to compare different options in different projects.

With this approach, you first add a 'Triangle Surface' rather than a 'Feature Surface' from the 'Elevations' menu.

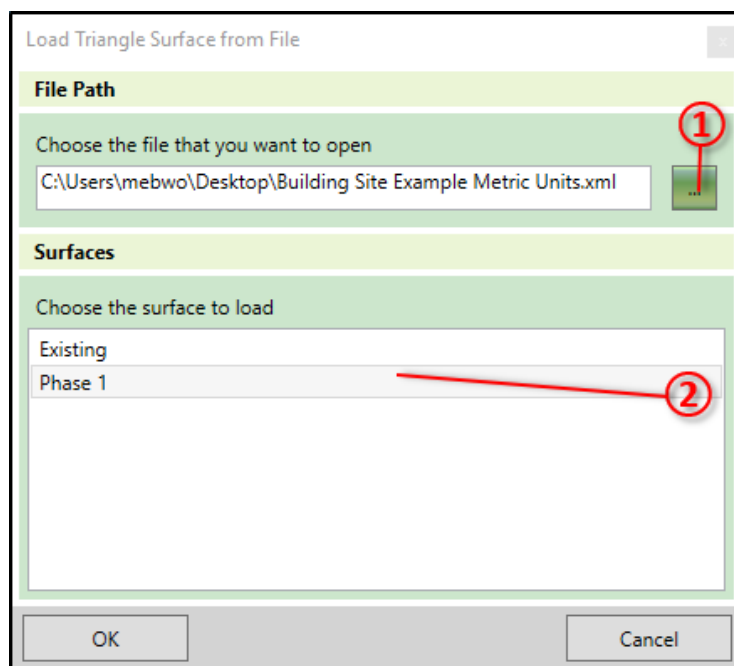

Triangle surfaces can be imported either from a TIN defined in a LandXML file (.xml) or a polyface mesh defined in a CAD file (.dwg, .dxf).



The video [Existing Levels - Triangle Surface](#) comprehensively covers the Triangle Surface and how to import triangle data.

## Existing Boundary Outline

In a 'Triangle Surface', the boundary of the site is derived from the boundary of the triangles. However, when defining existing ground with a 'Feature Surface', you need to define your own boundary. You can define a boundary with 'Varying Levels' whereby you input levels along the boundary outline yourself for maximum control. Alternatively, a 'Fixed Level Outline' can be used if all the levels along the boundary are the same. However, the outline type most frequently used is the 'Extrapolate Outline', which derives its elevations from the elevation features contained within.

When starting new projects, it can seem like a good idea to define the existing boundary to the proposed area of disturbance. In other cut and fill software often there is one fixed boundary used by both the existing and proposed elevations. However, in *Kubla Cubed* there is a more sophisticated design. There is nothing wrong with fixed boundaries per se, but it is not recommended. It is a bit similar to painting in that ideally, you need a canvas that provides plenty of space for the painting subject; you don't need to cut the canvas closely to where you intend the painting to be.

The disturbance area of a *Kubla Cubed* project is controlled with the boundaries of the proposed elements not the existing, and there are a number of reasons why having more existing surface than you need is advantageous, including:

- Visualisations look nicer if the proposed works are placed in context of the surrounding topography, rather than appearing to be floating in space.
- If the proposed design changes at a later date, the existing boundary does not need to be amended to accommodate an expansion of the disturbance area.
- The extrapolate outline, as it is calculated, not explicitly defined, sometimes needs to be corrected by adding elevation features inside the boundary. This is much easier to manage if the existing is larger than the proposed.

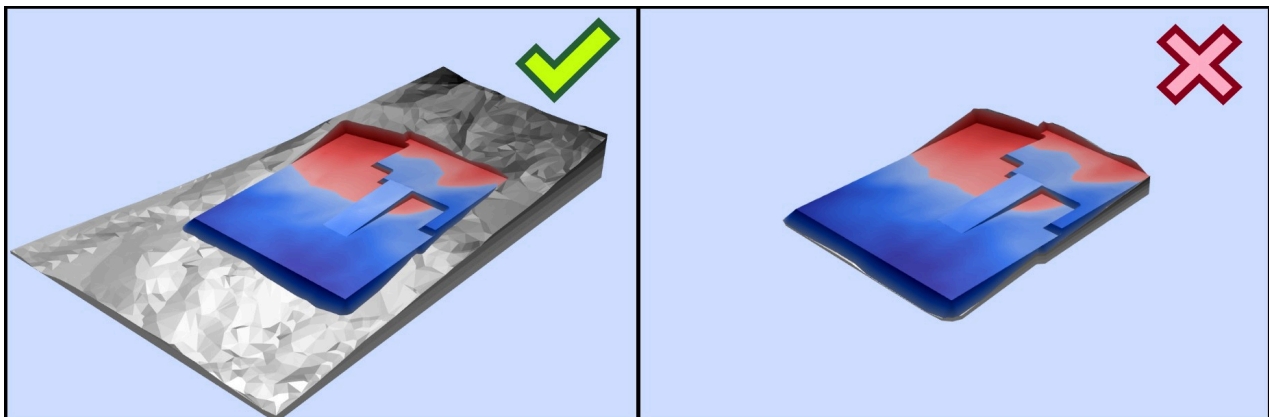

*Existing with contextual data (left) compared to just the area of disturbance (right)*

## Lidar and Photogrammetry data

The use of drones, aeroplanes and boats to capture topography is becoming more and more popular. As the cost and software/hardware improve, the speed and accuracy these types of surveys provide is becoming increasingly compelling. Lidar (Light Detecting and Ranging) surveys use a laser to read the surface elevation. They are usually mounted on boats or aeroplanes and can penetrate through light foliage and water. Photogrammetry is frequently used by drones. The drones take 1000s of photographs of the site at different positions. These photographs are then loaded into a computer, and by analysing the parallax effect of the images in a sequence an elevation surface can be generated.

Both these processes produce data that can be loaded into *Kubla Cubed* as a point cloud. The one problem is that the data sets tend to be very large in size often they can be 10 million points in size. *Kubla Cubed* users can, in theory, convert this data into TINs and analyse the volume difference; however, memory, graphics and, processor limits will start to be hit. Therefore, *Kubla Cubed* has a built in point reduction algorithm. If you import a large dataset, you

will get a message asking you if you want to reduce the point cloud. If you select yes, you will get the point thinner window, as shown below:

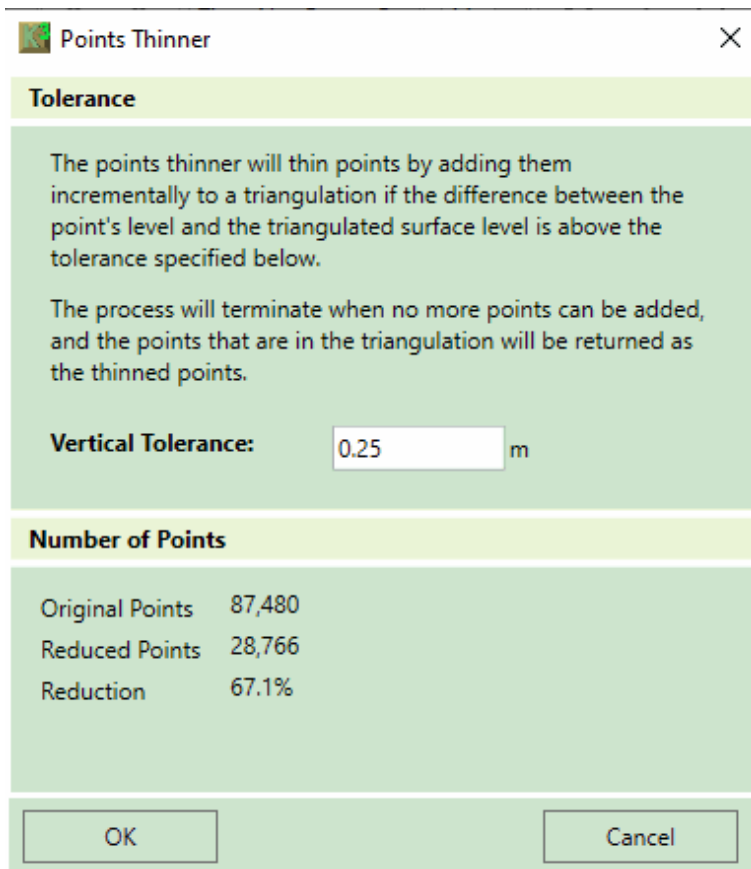

**Note:**

Currently, it is recommended that the maximum point cloud at which the software becomes difficult to operate is 80,000 for a modern laptop and 150,000 for a modern desktop PC.



---

# Chapter 10

---

## Topsoil Stripping

---

### Topics:

- [Reducing a Topsoil Strip by Specified Depths](#)
- [Excluding Internal Areas from a Strip](#)

Often, at the beginning of an earthworks project, the first operation will be to strip the site of topsoil. Topsoil will typically contain a far higher level of organic material, usually including a sod/turf layer; in an industrial context, it will contain a higher level of contamination (nails, glass, oil etc.). It is removed separately for reasons of material reuse and soil stability.

A topsoil strip entails excavating an area by a set depth. For instance, you may strip the entire site by 20cm. This is fairly easy to complete in *Kubla Cubed* with the 'Reduce Element'.

The two most important most important things to remember are to have:

1. Stripping calculation completed in its own distinct phase.
2. Earthwork operations that are to be completed after the strip, defined in subsequent phases.

There can be earthwork challenges, including a requirement to reduce different areas by different amounts and to exclude internal areas from a strip (e.g. there is an existing building or tree on the site which is to be preserved). Within this chapter, we will look how *Kubla Cubed* can model both of these scenarios.

## Reducing a Topsoil Strip by Specified Depths

### Create a Reduce Element for your Topsoil Strip

When you create a Reduce element you either trace or import an outline and then set the depth value. Essentially, this is all you need to complete a topsoil strip operation.

### Stripping the Entire Site

If you want to strip the entire site, you can simply draw the boundary beyond the extents of the existing ground surface. However, this work-flow is not recommended. We suggest having more existing ground than the disturbance area of your site as it produces better visualisations and makes it easier to spot errors at the disturbance area boundaries.

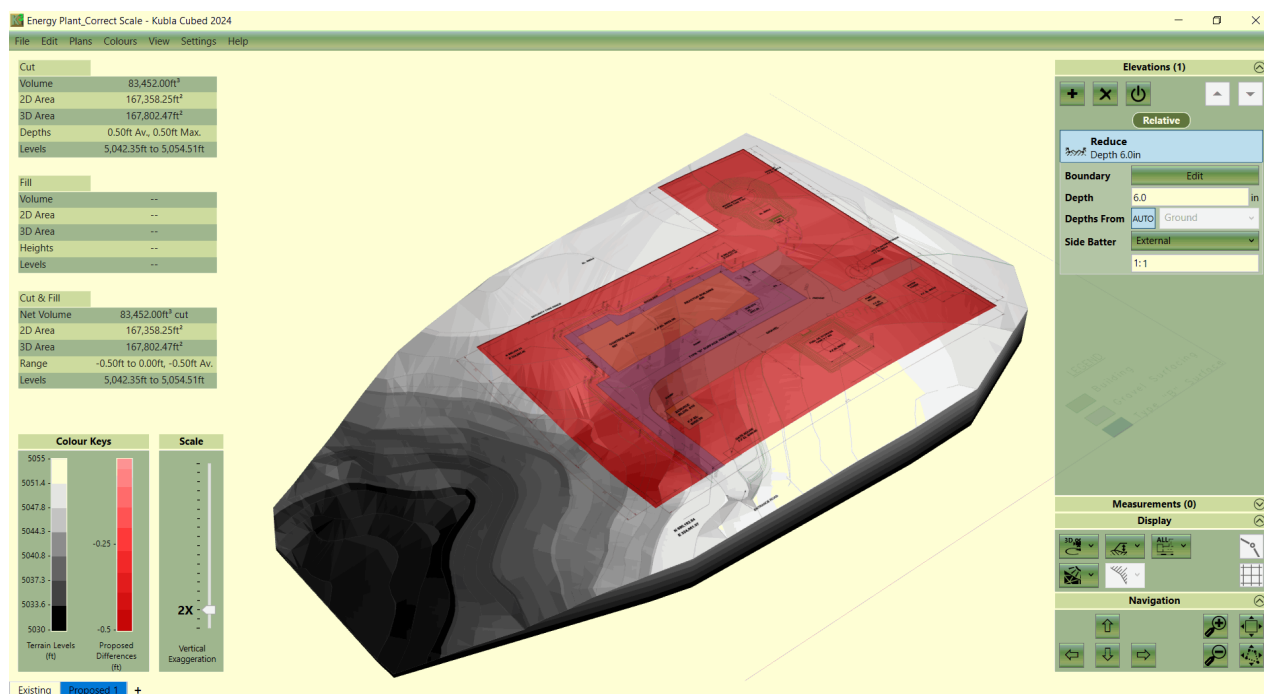

### Strips in Different Areas

If you want to complete strips in different areas, a Reduce element allows you to define multiple outlines, as long as they do not intersect with each other. However, a single Reduce element can only have a single depth value. If there is requirement is to strip different areas by different amounts then multiple Reduce elements should be used.

### Adjusting Side Batter

The side batter of topsoil strips are usually quite steep, so to reflect this, it might be a good idea to adjust the side batter angle from the default of 1:1 to something like 1:0.01 or even turn it off completely.

### Create a New Phase

After the topsoil strip has been defined, it is worth reiterating that you need to create a new phase in order to calculate from the strip level to another level (e.g. formation/subgrade level). If you overlaid a Platform or Feature Surface over the top of the Reduce element in the same phase, the elevations from those elements would override the elevations of the strip (see Calculation Order). This is not what we want; we want those elevations to be calculated from the topsoil strip level so another phase is required to complete this operation.

### What Happens when Reduce Elements Intersect?

If Reduce elements overlap, they will override each other. Where they intersect, the depth in the lower element in the calculation order will take precedence. This can be used to your advantage if there are two adjacent Reduce areas or an internal Reduce area. Instead of snapping the individual areas together, you can override them and decide which depths are used in the intersecting areas by changing the calculation order. This works as a Reduce element has the 'Depths From' property set to 'Ground' by default if there are no absolute elements above in the calculation order. It is not recommended to change these options from default or use absolute elements in a strip phase so the behaviour of Reduce elements overriding each other is consistent.

## Excluding Internal Areas from a Strip

---

It is sometimes necessary to exclude internal region from a topsoil strip. This might be the case if there is a tree or an existing building foundation in the middle of the site. The suggested way of doing this is to edit a reduce element and create an outline within the outline that defines the boundary. The system will treat an internal outline as an inner boundary effectively 'punching out' the inner area and excluding it from the reduce operation. You can define as many exclusion areas as you need with additional outlines.

---



The [Topsoil Stripping](#) video demonstrates using the Reduce element for topsoil stripping operations and explains the importance of defining strip depths on a separate phase from subsequent earthwork elevations.

---





---

# Chapter 11

---

## Demolition

---

### Topics:

- [Breaking Out Concrete Areas](#)
- [Milling Paved Areas](#)
- [Calculating the Volume of Demolished Materials](#)

If a proposed construction project is taking place on a site with existing structures, then a demolition phase may be required. For projects on empty land, no demolition calculations are needed. Alternatively, if the existing levels have been surveyed post-demolition, no calculation is required in that scenario either.

While the majority of demolition estimating falls outside the scope of a volumetric analysis program like *Kubla Cubed*, the program can be useful in analysing certain activities where an estimation of volume is required. Even if these volumes are not necessary, it is crucial to complete the demolition phase to adjust existing elevations properly for use in calculating volumes in subsequent phases.

Consider a project with a 400mm thick concrete foundation to be removed during demolition. Without a phase that reduces that level, subsequent phases calculating over that area will be inaccurate, as they will be calculating from the pre-demolition level rather than post-demolition.

Demolition must be defined in its own phase. If earthworks elements are placed over demolition areas in the same phase, they can override the demolition levels, effectively making the demolition elements redundant. Instead, demolition elements must be in their own phase so subsequent operations are calculated from the demolition level rather than overriding it.

## Breaking Out Concrete Areas

Concrete areas often need to be broken up and removed before building works can proceed. Typically, this involves reducing the level of an area to a specific elevation. For this activity, one or more platforms can be used to reduce to a fixed level.

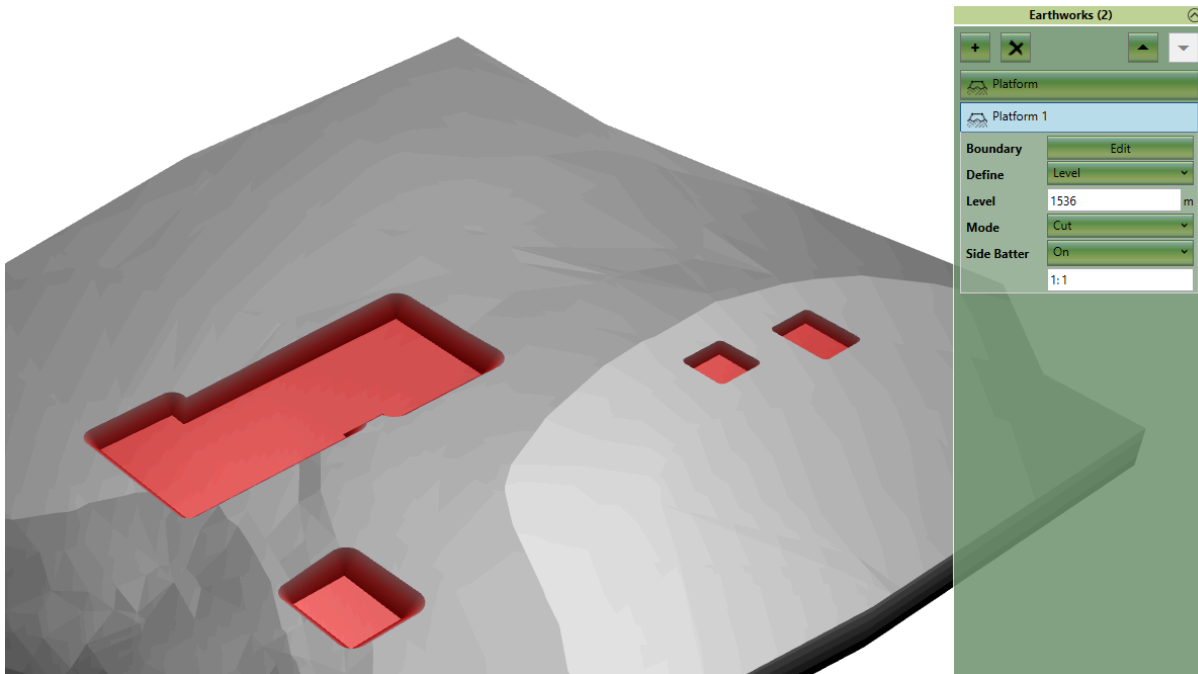

As this is an excavation-only activity, it is worth setting the 'Mode' to 'Cut Only'. This means that the elements will only calculate cut and not fill.

## Milling Paved Areas

A paved area can be milled to remove a surface layer to reduce the level, then to reuse the material elsewhere in the project or recycle it. For this operation, you need to reduce the ground by a set amount rather than to a set level. Naturally, the 'Reduce' element is perfect for this, as it allows you to specify both the area and the depth you want to reduce it by.



*Defining a section of road, milled to a depth of 200mm with a Reduce Element.*

## Calculating the Volume of Demolished Materials

---

Another scenario in which *Kubla Cubed* can be used, is if a demolition has taken place and you need to calculate the volume of demolished materials that remains on site. Usually, different materials will be collected into different piles called stockpiles. A survey can be done of the elevations of these piles and *Kubla Cubed* can be used to estimate the volume of each stockpile. There is a chapter dedicated to stockpile estimating later on: [Stockpile Volumes](#) on page 139



---

# Chapter 12

---

## Bulk Earthworks

---

### Topics:

- [Bulk Earthworks - Overview](#)
- [Adjusting to Subgrade / Formation Level](#)
- [Soft Landscape \(Ponds, Gardens, External Works, etc.\)](#)
- [Hard Landscape \(Building Pads, Drives, Car Parks, etc.\)](#)
- [Recreational Grounds \(Golf Course, Sports Pitch, etc.\)](#)
- [Roads and Paths](#)
- [Retaining Walls](#)

Bulk Earthworks is the operation that takes place after a strip or demolition phase of a project. It is the process of building up or excavating to get to the formation level or subgrade level specified on the construction plans. There are different approaches required for different scenarios. In this chapter, we will discuss some common scenarios and a recommended approach. However, *Kubla Cubed* is a flexible 'do all' volumetric calculator. These suggestions can be discarded if, through experimentation, you find a better approach that works best for your workflow.

## Bulk Earthworks - Overview

When defining bulk earthworks, it is possible to utilise all the element types to create the proposed topography, or it is possible to use just use one. The definition of bulk earthworks elevations usually requires quite a bit more thought and planning than, for instance, the existing, strip or demolition phases which can be quite straight forward.

In regard to the best approach, it often depends on what data you have in your site plan. If you have a set of contour lines defining smooth terrain, it would be best to use a 'Feature Surface' and use contour lines. However, if you have a series of terraced areas, then a number of platforms might be appropriate. For a warehouse foundation, with a number of ramps you could use some platforms and slope elements or define the whole thing in a 'Feature Surface' with break-lines.

## Adjusting to Subgrade / Formation Level

Most site plans do not have the subgrade level marked. Instead, they mark the final finished level (FFL) and have a separate plan of surface material thickness. When estimating bulk earthworks, we need to calculate to the subgrade, so we need to find a way of adjusting for the subgrade in our project.

**Notes on Terminology :** In some areas of the world, the term '*subgrade*' is used, and in others '*formation level*'. There are also several different terms used to refer to the level you will be standing on when the project has finished : '*finished floor level*', '*finished grade*' and '*final floor level*' are all used.

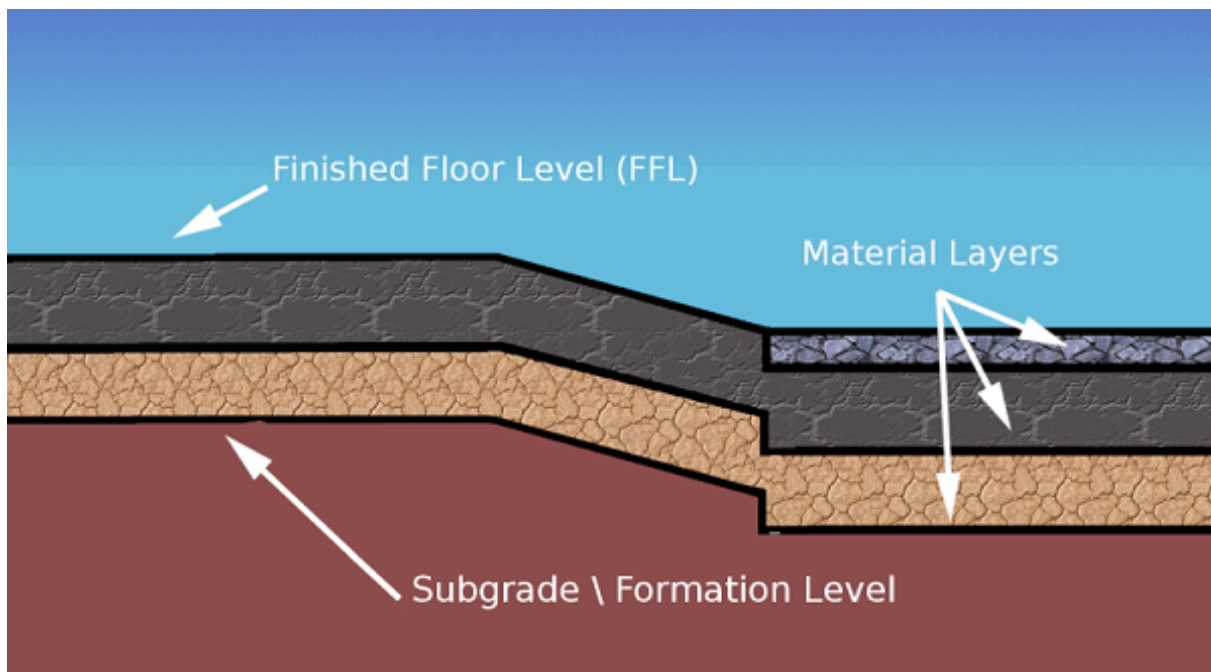

There is one issue that needs to be considered before starting, and that is how to approach the problem of elevations being marked at FFL level on a site plan (this is almost always the case). In the bulk earthworks phase, you will want to calculate to the formation/subgrade level not the FFL level, so we need some way of making these adjustments. In general there are three approaches :

### 1. The calculator method (not recommended)

This method involves manually adjusting elevations using a calculator before input. This works, of course, however, it is flawed. Imagine adjusting 30 contour lines by 600mm only to be told later that, after consideration, the engineer has decided to use a different build up and changes it to 700mm. Going back and adjusting with a calculator again is very time-consuming. The other issue with this method is that the elevations you look at on the plan don't match those you input, which makes it hard to check. We therefore recommend two alternative methods.

## 2. The Offset Method

The Offset Method is named such because we use the Z offset value that is available in all explicit absolute elements to offset an element with a negative value to make the required adjustment to the finished level. The Offset options found in the dropdown are 'Off,' 'Z', or it allows you to offset the entire surface in 'XYZ'.



This Offset Method works very well when the different areas of material thickness are represented by different elements in a project. For instance, if you have four building pads represented by four Platforms and a car park represented by a 'Feature Surface', it is easy to offset each 'Platform' and the 'Feature Surface' to adjust for different material thickness values. However, if the car park had different material thickness values across its surface, we would run into a problem as there is only one Z offset box for the entire Feature Surface. We could split it up into different chunks, but this can be awkward. Therefore, in this scenario the 'Reduce Method' can be used to work around the problem.

## 3. The Reduce Method

The 'Offset Method' for adjusting FFL levels works well in most circumstances; however, there are scenarios where you run into difficulties. On some site plans, it can be difficult to break the proposed into different material areas. Typically, this is the case when the proposed is defined by a single set of elevation features (contours lines or a point cloud). Breaking the proposed into different elements to cover different material thickness in this scenario can be awkward and lead to undesirable results at the boundaries of the different elements. As the contour lines or point cloud were not intended to be broken up, you can end up with large step-downs or jagged edges in the terrain. You can often fix this by adding more elevation features along the boundary, but another approach is to use the 'Reduce Method' as opposed to the 'Offset Method'.

The 'Reduce Method' involves putting all the proposed elevations at FFL into a single 'Feature Surface'. You can actually use a number of absolute elements (Platform, Slope, etc.) but in a simple setup, a single 'Feature Surface' is used. Once you have finished defining the FFL levels in your absolute element, you then layer 'Reduce' elements over the top of the Feature Surface to adjust different areas by different material thicknesses.

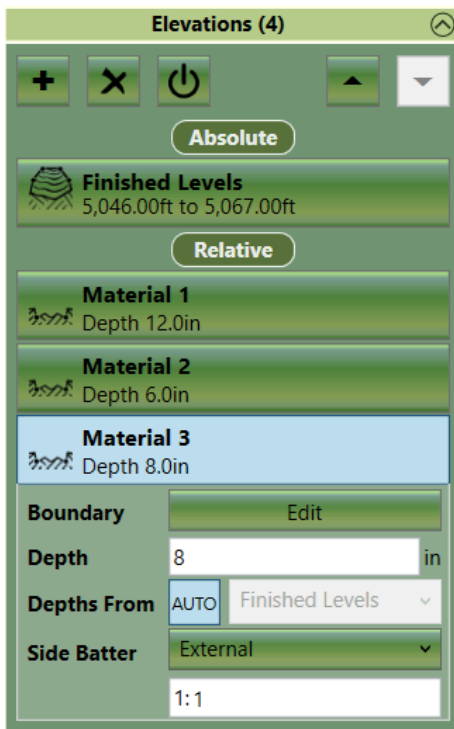

'Reduce' elements that intersect will override each other if 'Depths From' is set to 'Auto'. The lower reduce element in the list will take precedence in the area of intersection. It is not recommended to change the setting from 'Auto' when using the 'Reduce Method' to adjust FFL levels as it is set perfectly to adjust lower FFL elements.

If following the 'Reduce Method' there are certain key rules you need to follow:

1. 'Reduce' elements must be in the same phase as the elements that define the finished level.
2. The 'Reduce' elements must be below the finished level elements in the calculation order.
3. Usually the 'Reduce' elements have a very steep side batter (e.g. 0.01 or 'Off').
4. The 'Reduce' elements should have 'Depths From' set to 'Auto'.

The 'Reduce Method' is, in some ways, simpler than the 'Offset Method'; however, surfaces created using the 'Offset Method' can utilise the powerful side batter creation functionality in *Kubla Cubed* to create nice joins between different areas. With the 'Reduce Method' you have to create these side batters yourself with break-lines, contours and points. You can partially overcome this by using a number of absolute elements to define the FFL levels for areas that can be separated (e.g. building pads, parking lots etc...).



The [Adjusting to Subgrade / Formation Level](#) video covers adjusting FFL levels to the subgrade using the offset and reduce methods.

## Soft Landscape (Ponds, Gardens, External Works, etc.)

Soft landscaping areas are usually defined in a site plan with either points or contour lines. Sometimes break-lines are used if there is a hard edge to the surface, for instance, if there is a slight ridge or gardens have a distinct terraced design.

The 'Feature Surface' is usually the correct element to use for this as you can define proposed with points, contours, and break-lines with it. Even though soft landscape areas often do not need adjusting to a subgrade\formation level, it



is a good idea to separate different soft landscape works into different elements. For instance, you might have one for gardens and another for ponds. This has advantages when it comes to reporting.

Ponds will most frequently be designed with concentric contour lines. However, it is possible to use a platform element or a number of different platform elements overlaid atop one another to design a pond.

Sometimes as well, you may have a soft landscape area that needs just adjusting by a specified depth or height. For instance, if you wanted to just spread topsoil over an area you might want to just raise it by a certain height. To do this kind of operation, you would use the 'Reduce' or 'Raise' elements.

In a bulk earthworks phase, the software landscape areas are usually defined first and are at the top of the calculation order. This is so hard landscape areas such as building pads, car parks, roads and paths override them. For instance, a typical calculation order for a housing estate would be:

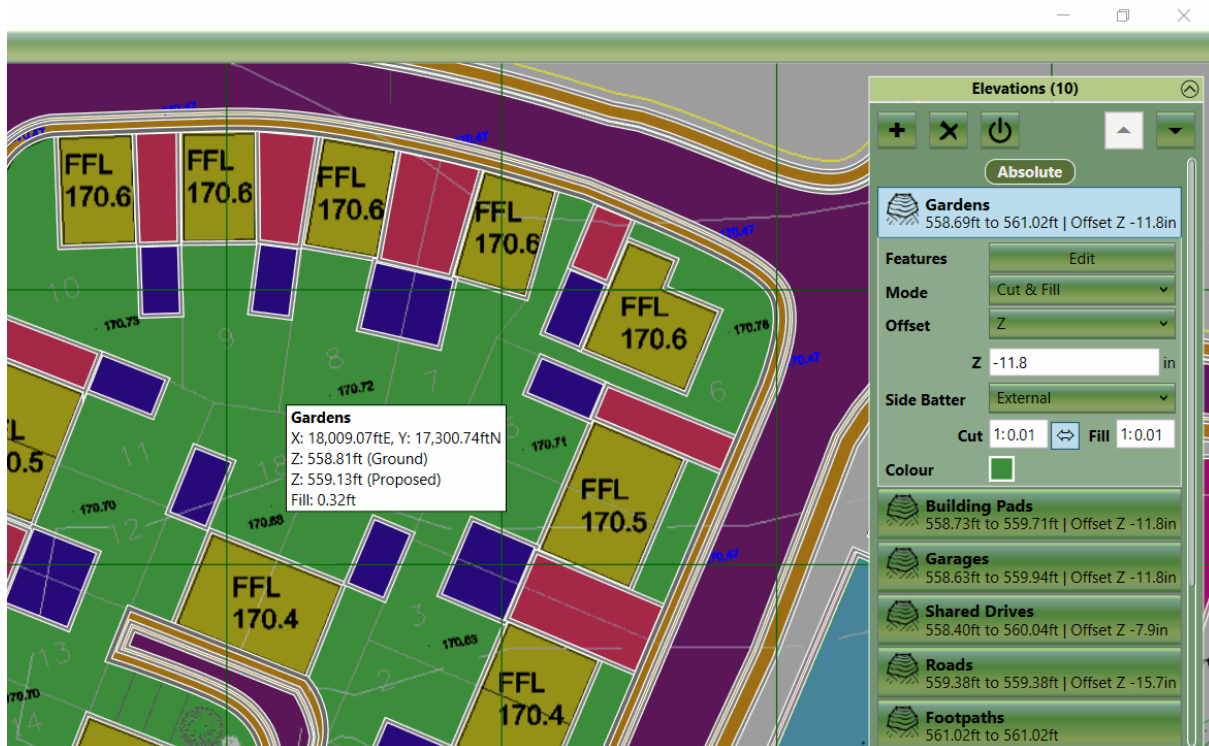

**Note:** The soft landscaped areas *Gardens* are higher in the calculation order; when they intersect with the hard landscape areas, defined in lower elements, they are overridden.



The [Kubla Cubed Detention Ponds / Basins](#) video explains how to design ponds with elevations from a fixed datum, depths from a base level, and calculating volumes using contour lines from a site plan.

## Hard Landscape (Building Pads, Drives, Car Parks, etc.)

If you are following the 'Reduce Method' approach of defining the entire site in a 'Feature Surface' and then adjusting to a subgrade/formation level using the 'Reduce' element, then hard landscaping can be modelled with contour lines and break-lines. Points are not a good way of defining hard landscaping areas, as they are not necessarily joined in the way you would expect for hard edges (e.g. the edge of a building pad or car park).

Firstly, closed contour lines can be used to define building pads and other flat areas. Break-lines can be drawn around the perimeter of car parks etc., to add that detail. However, when modelling hard landscaping, the 'Offset Method'

by which different areas of construction thickness are defined in different 'Feature Surfaces' tends to create accurate surfaces far more easily than the 'Reduce Method'. With the 'Reduce Method', a lot of time is often spent on break-lines, contours, and points to get the same effect of a few elevation elements combined. This is because *Kubla Cubed* generates side slopes for all elements. However, when defining the whole site in one feature, all the side slopes of buildings, car parks, ramps etc. have to be defined with contours, etc.

As with all take-off work, there is no one correct way to define things; however, the following recommendations provide a good starting point when using the 'Offset Method' regarding which elements to use:

- **Building Pads, Drives, Garages:** For these, the 'Platform' element can be used. Different areas in the same Platform element can be defined with different outlines. However, all areas in a single 'Platform' will have the same elevation. If you have many pads with different elevations (such as in a housing project), a 'Feature Surface' will allow you to define different pads with the 'Fixed Level Outlines'. A unique 'Fixed Level Outline' for each pad.
- **Car Parks:** If the car park is a consistent slope or two consistent slopes, the 'Slope' element can be used. Frequently, though, a car park is defined on a plan with elevations along the perimeter. In this case, it is often easiest to use a 'Feature Surface' and a 'Varying Level Outline'. Break-lines or points can be used, to add extra elevations inside the car park for added details.
- **Ramps:** The 'Slope' element is useful for creating ramps. If the ramps are all on the same plane, multiple outlines within the same 'Slope' element can define them. However, if they are not, then multiple slope elements can be used.

When using the 'Offset Method' and splitting areas into different 'Feature Surfaces', some consideration needs to be made regarding the order of the elements. The elements lower in the calculation order will override the ones above. It is a good idea to put the more expansive areas at the top and the more detailed areas lower down. You don't need to carefully snap the boundaries between different areas together if you use the overriding behaviour strategically.

## Recreational Grounds (Golf Course, Sports Pitch, etc.)

---

Sports pitches often are very simple geometrically. For instance, a football pitch or tennis court could be simply defined with a 'Platform'. However, these types of pitches, although appearing to be flat, often are on a slight slope for drainage reasons. Therefore the slope element might be more appropriate.

A baseball pitch requires a bit more consideration. In this case, there is usually a falloff in elevation from the pitcher's mound. This can be achieved by creating a feature surface and using concentric contour lines to define the desired topography.

Golf Courses tend to feature smooth, undulating terrain. However, hard edges exist at the perimeter of bunkers and ponds. On a plan, a golf course design is likely to be specified with contours, points and break-lines. The break-lines would be used for the defined edges, such as the bunker or water feature perimeter. Naturally, for these scenarios you would use a 'Feature Surface' in the proposed phase to design a golf course. It is also possible to prototype different golf course designs by combining different elements together. For instance, using Platforms to sketch out ideas can be far quicker and simpler than designing with contour lines. When happy with the design and estimated volumes, exporting contour lines to CAD could be useful for additional refinement and to create a smoother surface than that which was created with overlaid Platforms.

## Roads and Paths

---

There are several ways to define roads and paths in *Kubla Cubed*. Starting with a simple footpath, the obvious choice is to use the 'Path' element. This allows you to place points along the centre line of a path and set absolute elevations. If you leave a point's Z entry blank it will interpolate from its neighbours. After creating the centre lines, you can set a width of the Path. Another choice for a simple path is to create a 'Berm'; this will follow the topography of the centre-line at the specified relative heights specified.

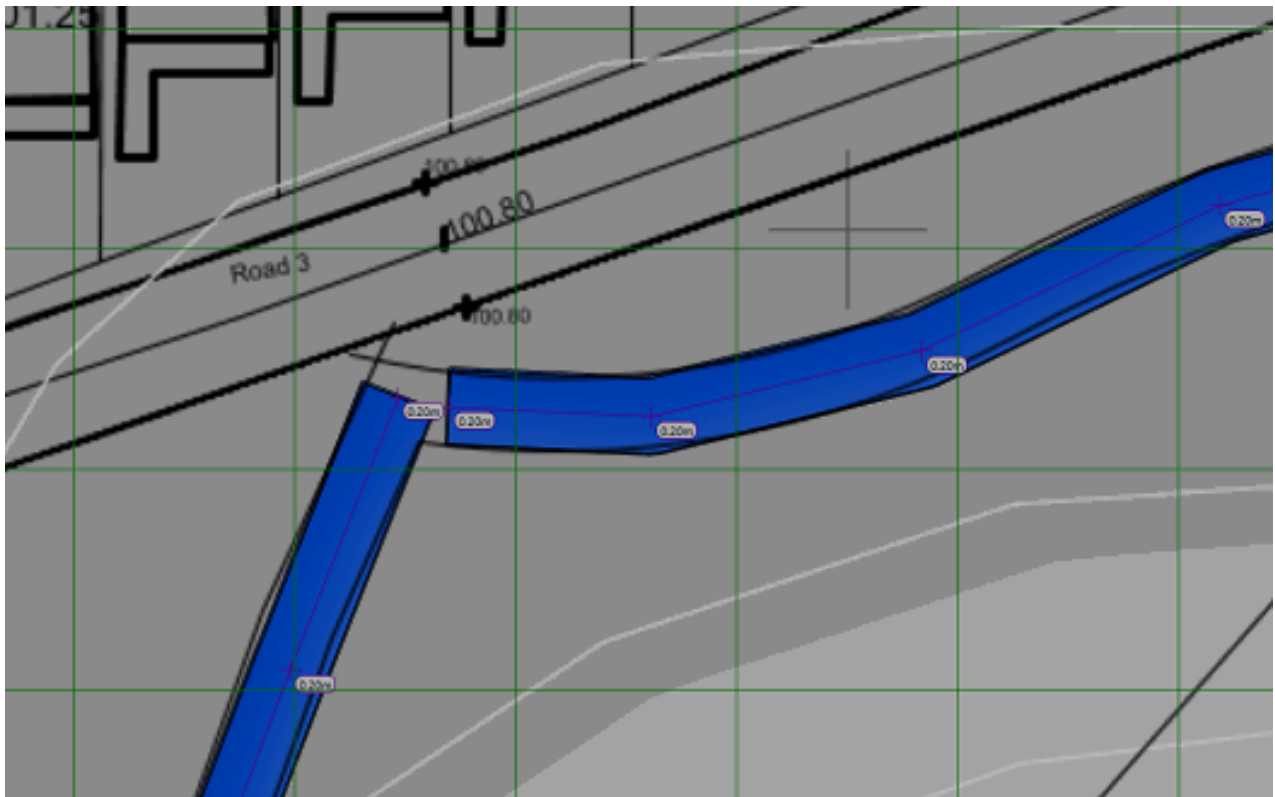

If you are defining roads, you can, of course, use the 'Path' and 'Berm' elements in the same way. However, it is usually better to use the 'Feature Surface' for roads that handle traffic. With the 'Feature Surface' you define the perimeter of the road with a 'Feature Surface' outline. You can also use an outline within an outline to define a road that completely encloses a space.

There are a few different approaches to take in regard to defining the feature surface depending on the data that is marked on the site plan:

- **Extrapolate Outlines and Contour Lines (Not Recommended)** : This works OK, but hundreds, if not thousands, of contour lines are often required to represent a road surface smoothly. The other methods are more efficient. This method is only used if contours are already defined in CAD or are the only thing marked on the site plan.
- **Extrapolate Outline and Break Lines (Quick)** : Another approach for defining roads with a 'Feature Surface', which is quite quick, is to define the centre line with a break line and then the road perimeter with an 'Extrapolate Outline'. This creates a flat road surface, which isn't optimal as most roads have a camber.
- **Varying Levels Outlines and Break Lines (Recommended)** : The recommended approach for defining a road surface is, within a 'Feature Surface', define a centre line with a break line and then use a 'Varying Level Outline' to input the levels of the road perimeter. This allows you to define the camber of the road, which is often desirable to get the most accurate surface. If there is no centre line marked on a site plan, using a 'Varying Level Outline' without the centre line is the best option.

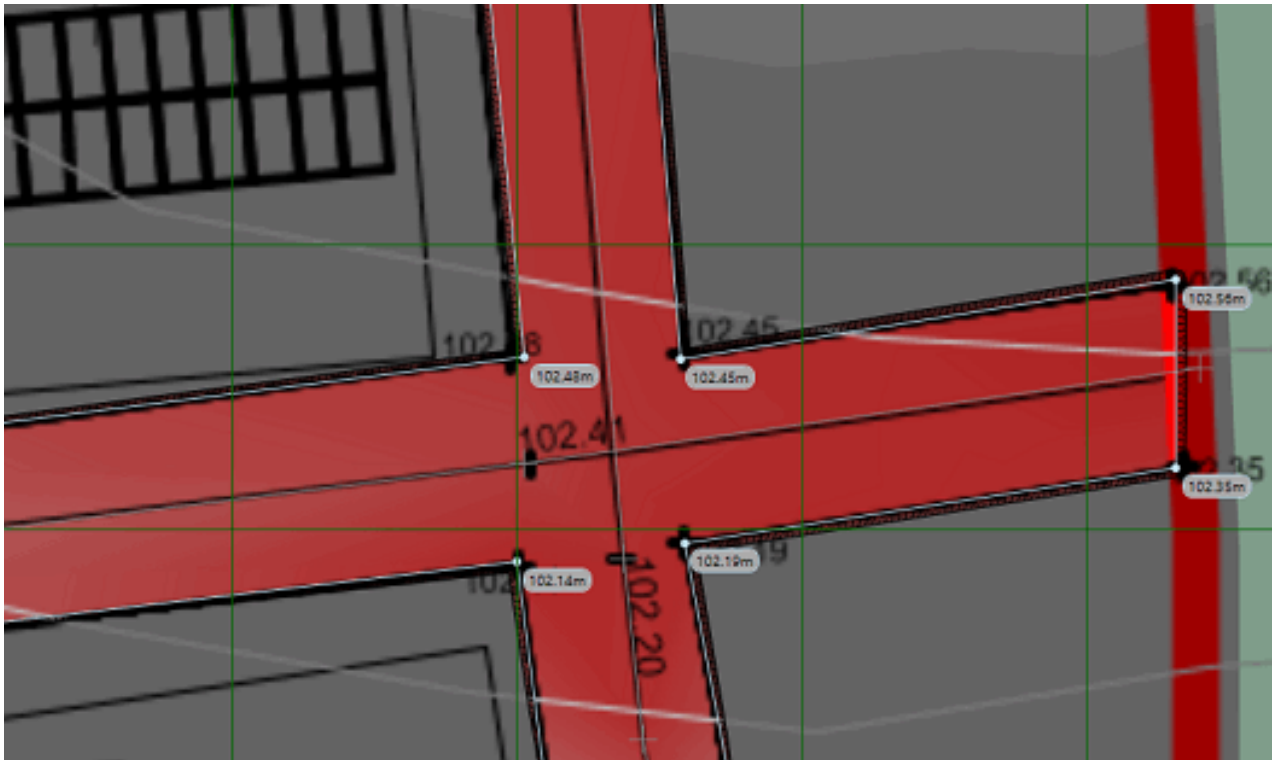

We've discussed the road surface, but often you will also want to complete footpaths down the sides of roads for pedestrian or bicycle traffic. This can be achieved by creating separate 'Feature Surfaces' below the main road surface in the calculation order for the pavements. If using the 'Offset Method' of subgrade adjustment, you can then offset the road surface and footpaths separately. To avoid having to snap the side of the pavements to the sides of the roads exactly, it is best to define the footpaths in the same phase as the road surface. If the footpaths are lower in the calculation order then you can tuck the roads underneath the footpaths. In the areas of intersection, the footpaths will override the road elevations, creating a smooth join between the two.



The [Roads and Paths](#) video demonstrates three methods for defining roads and paths, in *Kubla Cubed*.

## Retaining Walls

There are broadly two different approaches to defining retaining walls: The first is using break-lines within a 'Feature Surface', and the second involves combining different elements together like the 'Platform' and 'Path' together. If adjusting to subgrade using the 'Reduce Method' (i.e a 'Feature Surface' with a number of 'Reduce' elements) then break-lines within the 'Feature Surface' would be used. However, when employing the 'Offset Method' you could still use break-lines within a 'Feature Surface', and there is also an option of building up the retaining wall with various elevation elements.

### Break-Lines

With the break-line method, you would first input the elevations on both sides of the wall. These would likely be points but could also be with contours that stop just shy of the wall. Then, you would input two break-lines: one at the top of the wall and one at the bottom. The gap between the break-lines would indicate the width of the wall slope when viewed on a plan. For instance, a near vertical wall would have break-lines very close, whereas as are gentle slope would be much wider.

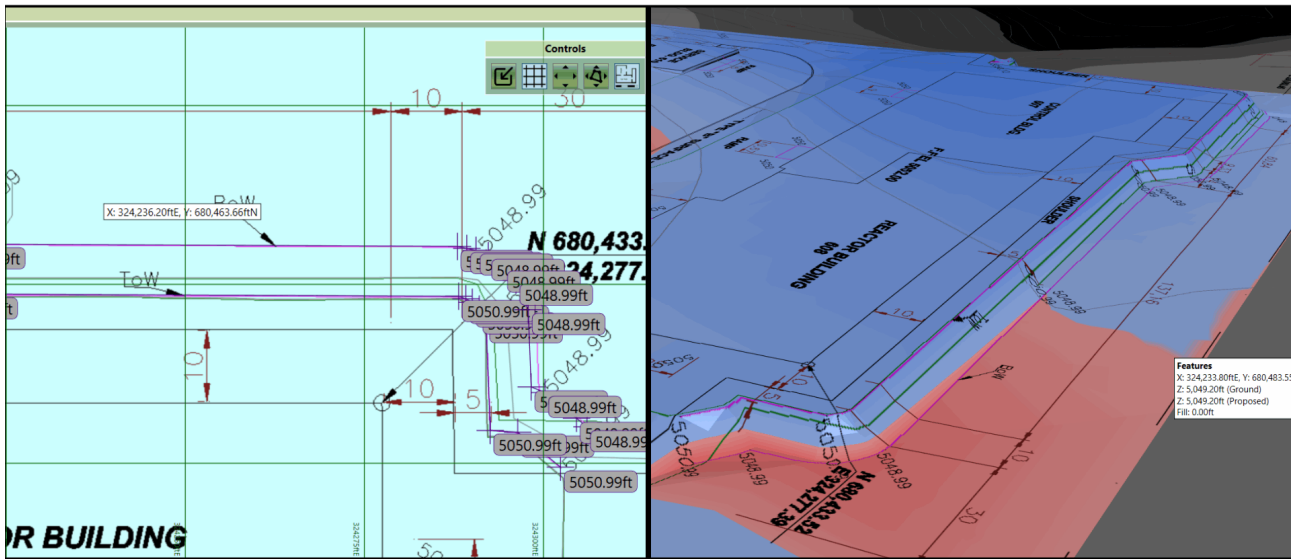

### Combining Elements

Another approach with retaining walls is to define them by combining different elements. For instance, the wall itself can be represented by a 'Path' (using absolute elevations) or a 'Berm' (using relative elevations). The backfill can then be defined with a 'Platform' element if the area is flat or a 'Slope' or 'Feature Surface' if not. With a backfill element, such as a 'Platform' it might be advantageous to set the mode to 'Fill' only so the element only fills to the ground and wall level rather than cutting from it.

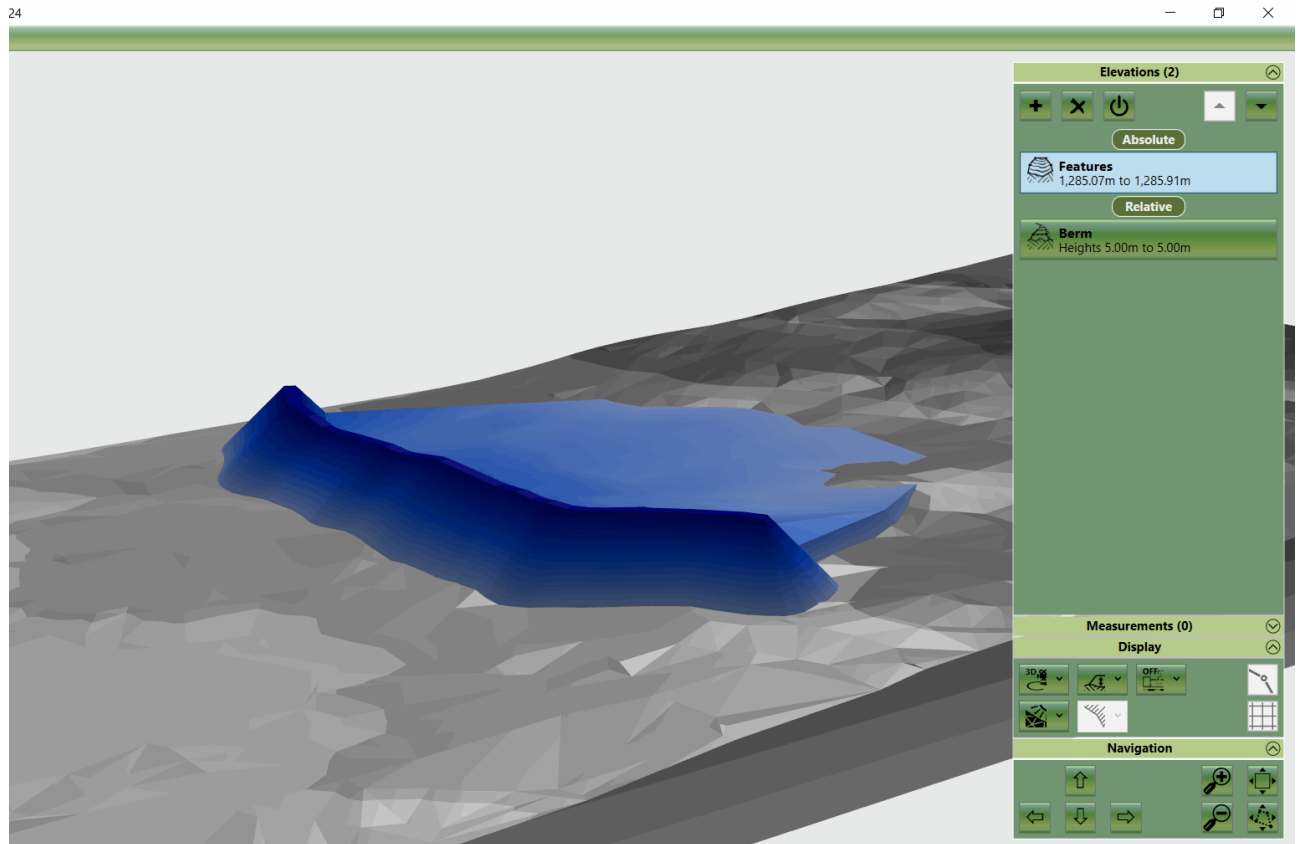

### Side Batter to Define Retaining Walls

Using *Kubla Cubed* elements such as the Feature Surface, Platform, or Triangle Surface, you can define the element and then edit the side batter to generate a wall. For example, the image below shows a terraced landscape using the three elements mentioned previously. Watch our video on retaining walls to see how this is done.

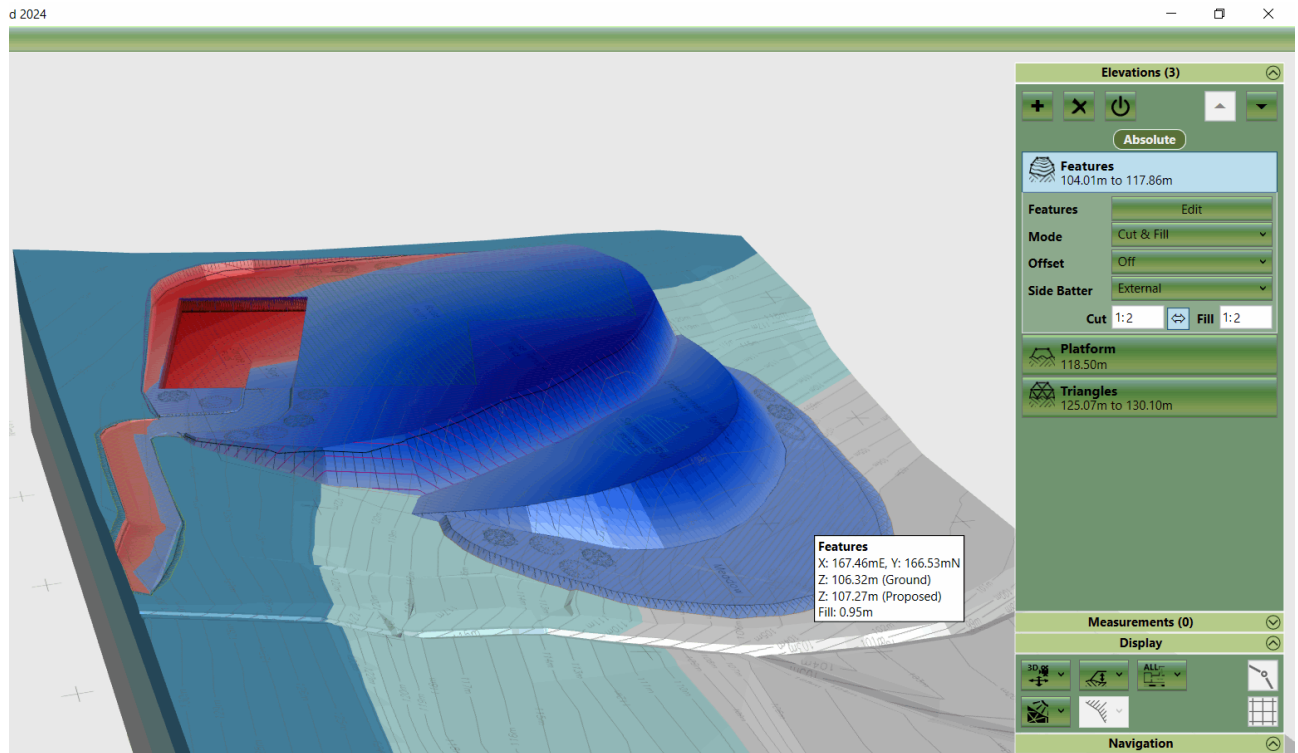

The [Kubla Cubed | Defining Retaining Walls](#) video explores methods for creating dramatic topographical changes with *Kubla Cubed's* tools.

---

# Chapter 13

---

## Utility Trenches

---

**Topics:**

- [Trenches, Ditches](#)

Trenches, channels, and ditches are excavated for utilities such as gas, water, sewage pipes and telecom cables. *Kubla Cubed* offers excellent tools, including Trench, Path and Berm, which can be utilised to define the trench and complete multiple backfill phases.

## Trenches, Ditches



In *Kubla Cubed*, two key elevation elements are useful for defining trenches.

### 1. Trench Element:

When using the Trench element, set the depth by using a positive value. The Trench element is a [relative element](#), so the values are specified as 'depths'.

### Style of Trench:

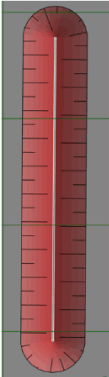
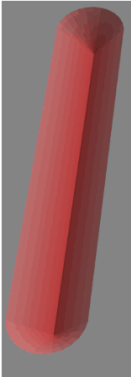
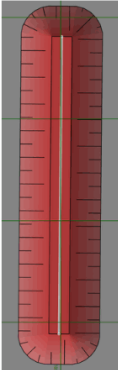
With some small changes, you can adjust the appearance of a trench. After defining a centreline and setting the depths, adjust the Width of the trench and Side Batter to generate different styles of trench. Three examples are shown below:

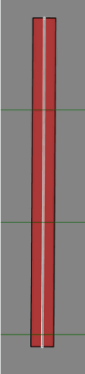
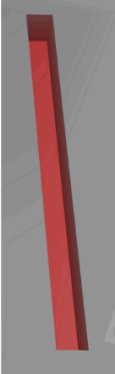
Trench Element Settings	2D Model	3D Model
<div style="border: 1px solid #ccc; padding: 5px;"> <p><b>V Trench</b> Depths 3.00m to 3.00m</p> <p>Centrelines <span style="float: right;">Edit</span></p> <p>Depths From <span style="border: 1px solid #ccc; padding: 2px;">AUTO</span> <span style="border: 1px solid #ccc; padding: 2px;">Ground</span> <span style="float: right;">▼</span></p> <p>Width <span style="border: 1px solid #ccc; padding: 2px;">0.00</span> m</p> <p>Mode <span style="border: 1px solid #ccc; padding: 2px;">Cut</span> <span style="float: right;">▼</span></p> <p>Side Batter <span style="border: 1px solid #ccc; padding: 2px;">External</span> <span style="float: right;">▼</span></p> <p><span style="border: 1px solid #ccc; padding: 2px;">1:1</span></p> </div>		
<div style="border: 1px solid #ccc; padding: 5px;"> <p><b>Sloped Sides Trench</b> Depths 3.00m to 3.00m</p> <p>Centrelines <span style="float: right;">Edit</span></p> <p>Depths From <span style="border: 1px solid #ccc; padding: 2px;">AUTO</span> <span style="border: 1px solid #ccc; padding: 2px;">Ground</span> <span style="float: right;">▼</span></p> <p>Width <span style="border: 1px solid #ccc; padding: 2px;">2.00</span> m</p> <p>Mode <span style="border: 1px solid #ccc; padding: 2px;">Cut</span> <span style="float: right;">▼</span></p> <p>Side Batter <span style="border: 1px solid #ccc; padding: 2px;">External</span> <span style="float: right;">▼</span></p> <p><span style="border: 1px solid #ccc; padding: 2px;">1:1</span></p> </div>		
<div style="border: 1px solid #ccc; padding: 5px;"> <p><b>Vertical Sides Trench</b> Depths 3.00m to 3.00m</p> <p>Centrelines <span style="float: right;">Edit</span></p> <p>Depths From <span style="border: 1px solid #ccc; padding: 2px;">AUTO</span> <span style="border: 1px solid #ccc; padding: 2px;">Ground</span> <span style="float: right;">▼</span></p> <p>Width <span style="border: 1px solid #ccc; padding: 2px;">2.00</span> m</p> <p>Mode <span style="border: 1px solid #ccc; padding: 2px;">Cut</span> <span style="float: right;">▼</span></p> <p>Side Batter <span style="border: 1px solid #ccc; padding: 2px;">External</span> <span style="float: right;">▼</span></p> <p><span style="border: 1px solid #ccc; padding: 2px;">1:0.01</span></p> </div>		



The below image displays the cross sections of the three trench elements (above) giving another perspective of the differing Widths and Side Batters.



**Note:** In cases where two trenches intersect, the depth value from the trench with the greatest depth at the point of intersection will be used.

## 2. Path Element:

To define trenches using [absolute](#) elevations, use the Path element.

1. Draw the centreline (points on the line without a value will be interpolated).
2. Set width and side batters. To create a V trench, set width to 0.
3. If two paths intersect, the one with the higher depth will take precedence.

When using the Path element, if you leave an elevation blank, it will interpolate from the neighbors. For a constant elevation, set the same value at the beginning and end, leaving the others blank or marked as 'not set.'



---

# Chapter

# 14

---

## Foundations, Footings

---

### Topics:

- [Modelling Foundations](#)
- [Backfilling](#)
- [Filling Around Structural Elements](#)

*Kubla Cubed* is a general earthworks estimation software, allowing users to calculate foundation volumes, even though they are usually fairly straightforward to measure by simple hand calculations. However, there are advantages to modelling foundations in *Kubla Cubed*, particularly where backfilling around the foundations is required. Additionally, it is useful for creating step-by-step 3D images of the work taking place.

## Modelling Foundations

The volume of foundations can be modeled in *Kubla Cubed* in just the same way as any other earthworks element. The only real differences are that the side batter for foundations is almost always set to vertical, and foundations often have holes inside them. The ability to cut holes out of volumes is a standard feature in *Kubla Cubed*, but is much less commonly used for actual earthworks elements. Cutting holes is easily achieved by adding internal outlines within the external ones. The internal outlines will be automatically detected and removed as holes.

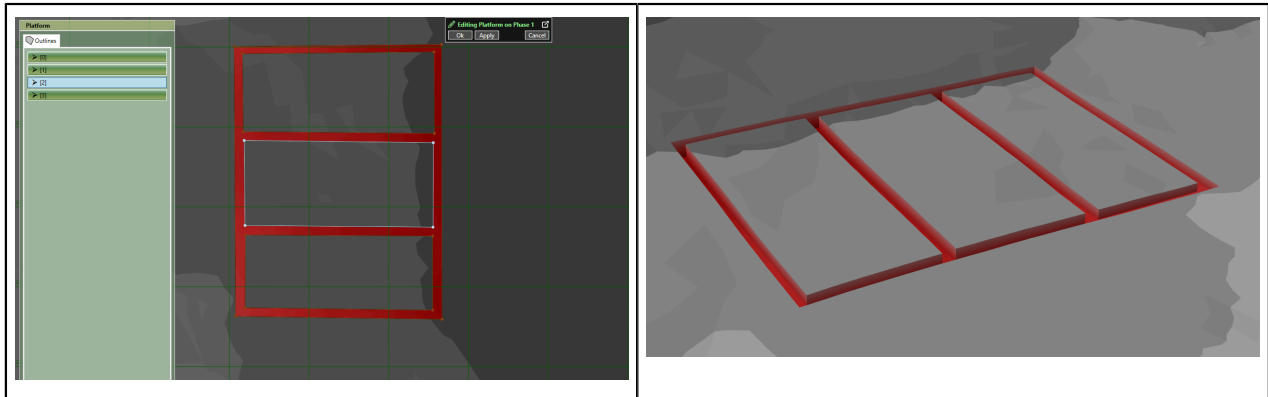

*The ability to remove internal areas is an occasionally used feature for normal earthworks elements but is routinely required when modeling foundations.*

## Backfilling

Backfilling is the process of filling up a cavity with material after an excavation. *Kubla Cubed* can be used to calculate the material that will be used in a backfilling operation. It is critical to note that an additional phase is required to complete a backfill operation; excavation and backfill cannot be completed in a single phase.

Several elements can be used to define the surface of the backfill material. However, there is a trick that can save time when tracing around the perimeter of a cavity. If we set an element like the 'Platform' to 'Fill' only mode it cannot cut from the surface. Using this technique, we can trace a 'Platform' over the general area of backfill, and it will fill up the cavities to the given level. As long as the elevations around the cavities are higher than the backfill level, than they will remain untouched.

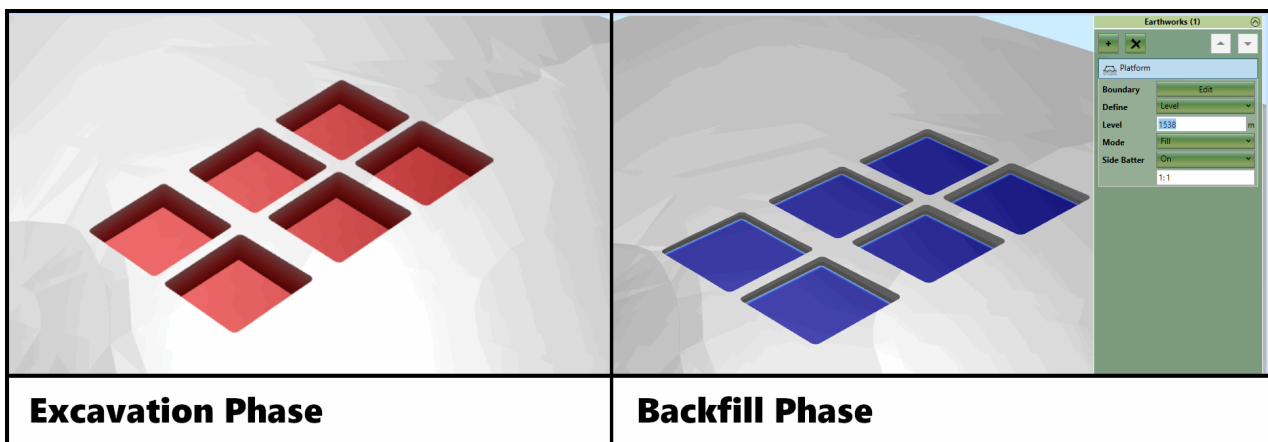

*Excavation in one phase has been backfilled in a subsequent phase by using a platform over the area and setting the platform to 'Fill' only mode.*

It's worth nothing that the backfill trick does not require the backfill to be at a set fixed level to work; you can use the same technique with any other absolute element (e.g. Slope or Feature Surface).

## Filling Around Structural Elements

---

Another trick that can be employed when estimating building foundation volumes is to create phase that contains structural elements, which will be ignored from the cut and fill calculations. The fill for these elements will be calculated, but it is often irrelevant, as the elements could be precast concrete or a temporary concrete framework. In a way, they could be described as 'dummy earthworks' elements used to create a solid surface where structural elements will be.

In a subsequent phase, elements can be set to 'Fill' only and fill can be added around those structural elements. This can make the job of filling around complex space a lot easier, and the visualisations make more sense. An alternative approach is to define the boundary outlines of the proposed structure carefully to leave the structural areas untouched. However, the models created by using 'dummy earthworks' for structural elements tend to be easier to understand.

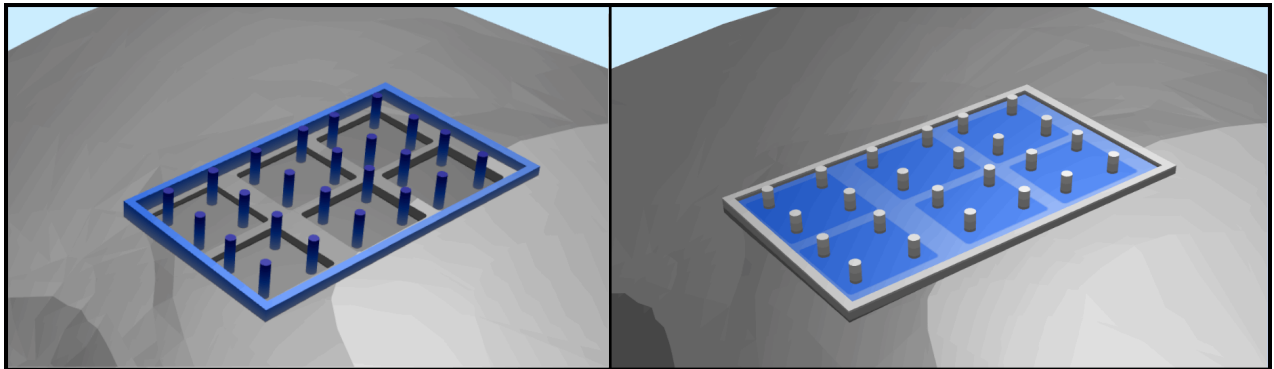

*Dummy earthworks used to represent precast concrete pillars and wooden frame before estimating concrete fill volumes in a subsequent phase.*



---

# Chapter 15

---

## Paving, Turf and Sod

---

### Topics:

- [Using Reported Areas to Calculate Paving Volumes](#)
- [Using the Raise Element to Report Paving Volumes](#)
- [Obtaining a Breakdown of different Paving Strata](#)

Paving refers to a layer of hard material that constitutes the surface of a built environment, such as a road, pavement, or driveway. In this chapter, we use the term more broadly to discuss the layers completed in the final phases of a project, building up to finished level. This can include materials such as turf (sod), asphalt, tiles, woodchip, or any other material. The bulk earthworks, as discussed in earlier chapters, will result in topography defined to the Formation/Subgrade Level with cavities where paving will be laid.

Estimating paving is commonly done by measuring the area and then calculating the the volume using a simple formula: Area x Paving Thickness. While this method is often sufficient, it is also possible to model the paving build up in *Kubla Cubed* by modeling the paving elevations and calculating the volumes.

## Using Reported Areas to Calculate Paving Volumes

---

Estimators commonly use *Kubla Cubed* for volume measurements and use another 2D take-off program to area measurements calculating the paving volumes by multiplying the area by the thickness. While this a straightforward approach, it may involve measuring the same areas twice—once in *Kubla Cubed* and once in the other program. This can be timeconsuming, requiring the importation of site plans twice and scaling and stitching twice.

*Kubla Cubed* offers a more streamlined alternative. The first method involves using the ‘Area’ element found in the ‘Measurements’ panel. With this, you can take-off area measurements and use the 2D Boundary Area in the ‘User Input’ reports for paving estimates. While effective, it does not use 3D areas and may require you to retrace areas previously traced during the bulk earthworks phases. Nevertheless, it does eliminate the need to import site plans into another program

### Choosing between 2D or 3D Areas

Before using areas to calculate paving volumes, it is worth considering whether to use 2D or 3D areas. The 2D areas reported are the same as if measured from a paper plan, often the traditional approach to estimating paving volumes. The 3D areas take into account the surface area of the topography and will always be the same or larger than the 2D area. While 2D areas are generally sufficient for calculating paving, 3D areas might be necessary on steep inclines where the surface area in 3D is far greater than when viewed from above. For instance, when calculating the turf needed for a golf course, relying solely on a 2D area might leave you considerably short of the true requirement.

Another method to obtain the areas is to use the disturbance areas from the earthworks estimation. You can choose between the 2D areas or 3D areas based on your requirements. If you have set up your bulk earthworks in either of the following ways :

- A. Using the ‘Offset Method’, where different paving areas are represented by different elements.

or

- B. Using the ‘Reduce Method’, where different paving areas are being reduced by different 'Reduce' elements.

Then the ‘Volumes by Element’ in the 'Estimation Spreadsheet' can be used to find the areas of the paving. Both 2D and 3D areas are available depending on your requirements.



Create Estimation Spreadsheet

A	B	C	D	E	F	G	H	I	J	K	L	M	N	O	P	Q	R
1		*Min Level (m)	*Max Level (m)	*Average Level (m)													
2	Ground Levels	170.1	170.6	170.32													
3																	
4	*For disturbance area only																
5																	
6																	
7	<b>VOLUMES BY ELEMENT (Lowest Element Reports in Intersecting Areas)</b>	<b>Depths (m)</b>	<b>Levels (m)</b>	<b>2D Area (m<sup>2</sup>)</b>	<b>3D Area (m<sup>3</sup>)</b>	<b>Volume (m<sup>3</sup>)</b>	<b>Heights (m)</b>	<b>Levels (m)</b>	<b>2D Area (m<sup>2</sup>)</b>	<b>3D Area (m<sup>3</sup>)</b>	<b>Volume (m<sup>3</sup>)</b>	<b>Range (m)</b>	<b>Levels (m)</b>	<b>2D Area (m<sup>2</sup>)</b>	<b>3D Area (m<sup>3</sup>)</b>	<b>Net Volume (m<sup>3</sup>)</b>	
8	Gardens	0.18 av. 0.43 max	169.99 to 170.6	8426.47	8433.96	1555.89	0.2 av. 0.6 max	170.1 to 170.7	8753.16	8768.73	1782.74	0.43 cut to 0.6 fill	169.99 to 170.6	17179.64	17202.68	2.65	
9	Building Pads	0.19 av. 0.4 max	170 to 170.6	8498.66	8823.67	1605.1	0.07 av. 0.6 max	170.1 to 170.7	6.86	324.79	0.47	0.42 cut to 0.6 fill	170 to 170.7	8505.52	9148.46	694.63	
10	Garages	0.19 av. 0.42 max	169.97 to 170.6	1493.72	1678.29	277.52	0.09 av. 0.49 max	170.1 to 170.64	0.9	89.73	0.08	0.42 cut to 0.49 fill	169.97 to 170.64	1494.62	1768.02	-277.44	
11	Shared Drives	0.1 av. 0.55 max	170 to 170.6	3818.75	2848.5	251.69	0.04 av. 0.6 max	170.1 to 170.7	995.73	1345.36	37.13	0.55 cut to 0.6 fill	170 to 170.7	3154.48	4193.86	-214.56	
12	Roads	0.22 av. 0.5 max	170.1 to 170.6	9187.27	9187.27	1981.48						0.5 max cut	170.1 to 170.6	9187.27	9187.27	-1981.48	
13	Footpaths	0.15 av. 0.55 max	170.05 to 170.6	7.65	765.15	1.17	0.68 av. 0.9 max	170.1 to 171	6455.98	10591.59	4400.11	0.35 cut to 0.9 fill	170.05 to 171	6463.53	11346.74	4396.94	
14	Detention Pond	1.82 av. 2.6 max	167.5 to 170.1	1493.91	1644.35	2713.51	0.49 av. 0.9 max	170.1 to 171	921.38	1028.51	448.74	2.6 cut to 0.9 fill	167.5 to 171	2415.29	2872.86	-2264.77	
15	Pavilion Paving	0.17 av. 0.31 max	169.95 to 170.26	372.69	402.41	83.33						0.31 max cut	169.95 to 170.26	372.69	402.41	-83.33	
16	Pavilion Building	0.44 av. 0.56 max	169.7 to 170.26	693.9	723.36	303.77						0.56 max cut	169.7 to 170.26	693.9	723.36	-303.77	
17	Parking Lot	0.09 av. 0.19 max	170.14 to 170.34	902.84	909.29	84.98	0.01 av. 0.04 max	170.19 to 170.23	77.7		78.08	1.15	0.19 cut to 0.04 fill	170.14 to 170.34	905.55	987.36	-83.82
18																	
19	<b>VOLUMES BY REGION</b>	<b>Depths (m)</b>	<b>Levels (m)</b>	<b>2D Area (m<sup>2</sup>)</b>	<b>3D Area (m<sup>3</sup>)</b>	<b>Volume (m<sup>3</sup>)</b>	<b>Heights (m)</b>	<b>Levels (m)</b>	<b>2D Area (m<sup>2</sup>)</b>	<b>3D Area (m<sup>3</sup>)</b>	<b>Volume (m<sup>3</sup>)</b>	<b>Range (m)</b>	<b>Levels (m)</b>	<b>2D Area (m<sup>2</sup>)</b>	<b>3D Area (m<sup>3</sup>)</b>	<b>Net Volume (m<sup>3</sup>)</b>	
20	NRM2 [1000mm to 500mm]Fill						0.7 av. 0.9 max	170.1 to 171	6607.32	7922.57	4607.74	0.9 max fill	170.1 to 171	6607.32	7922.57	4607.74	
21	NRM2 [500mm to 300mm]Fill						0.24 av. 0.5 max	170.1 to 171	8304.7	11599.26	2009.53	0.5 max fill	170.1 to 171	8304.7	11599.26	2009.53	
22	NRM2 [300mm to 0mm]Fill						0.02 av. 0.05 max	170.1 to 170.65	2239.61	2694.96	53.15	0.05 max fill	170.1 to 170.65	2239.61	2694.96	53.15	
23	NRM2 [0m to 2m]Cut	0.21 av. 2 max	168.1 to 170.6	32918.05	34617.44	6870.09						2 max cut	168.1 to 170.6	32918.05	34617.44	-6870.09	
24	NRM2 [2m to 4m]Cut	2.53 av. 2.6 max	167.5 to 170.1	777.82	798.8	1968.34						2.6 max cut	167.5 to 170.1	777.82	798.8	-1968.34	
25																	
26	<b>PHASE TOTAL VOLUMES</b>	<b>Depths (m)</b>	<b>Levels (m)</b>	<b>2D Area (m<sup>2</sup>)</b>	<b>3D Area (m<sup>3</sup>)</b>	<b>Volume (m<sup>3</sup>)</b>	<b>Heights (m)</b>	<b>Levels (m)</b>	<b>2D Area (m<sup>2</sup>)</b>	<b>3D Area (m<sup>3</sup>)</b>	<b>Volume (m<sup>3</sup>)</b>	<b>Range (m)</b>	<b>Levels (m)</b>	<b>2D Area (m<sup>2</sup>)</b>	<b>3D Area (m<sup>3</sup>)</b>	<b>Net Volume (m<sup>3</sup>)</b>	
27	All Elements	0.26 av. 2.6 max	167.5 to 170.6	33695.87	35416.24	8838.43	0.39 av. 0.9 max	170.1 to 171	17151.62	22216.79	6670.42	2.6 cut to 0.9 fill	167.5 to 171	50847.49	57633.02	-2168.01	
28																	
29																	
30	<b>LENGTHS</b>	<b>Tag</b>	<b>2D Perimeter (m)</b>	<b>2D Area (m<sup>2</sup>)</b>	<b>2D Length (m)</b>	<b>Count</b>											
31	Length	[0]			14.87												
32	Element Total				14.87	1											
33	Length 2	[0]			63.96												
34	Element Total				63.96	1											
35																	
36	<b>COUNTS</b>	<b>Tag</b>	<b>2D Perimeter (m)</b>	<b>2D Area (m<sup>2</sup>)</b>	<b>2D Length (m)</b>	<b>Count</b>											
37	Count	[0]															
38		[1]															
39		[2]															
40		[3]															
41		[4]															
42		[5]															
43	Element Total					6											
44																	

Existing Demolition Strip Bulk Earthworks

OK Cancel

There is one catch with this method: if an element does not actually change the ground in a specific area, for instance, if an earthworks element only ends up changing 70% of the ground (i.e., some of the proposed levels match the ground level), the disturbance areas will not report the whole area. Therefore, it cannot be used for paving calculations. Another issue may arise when disturbance areas include the side batter of an element, which may not be what's required. In this case, another method would have to be used.

**Why not use Boundary 2D Areas contained in the User Input Reports?**

It is possible to use Boundary 2D Areas reported in the 'User Input' reports for this task, but there are a couple of issues. Firstly, they report the area of the boundary outline, which does not include the side slopes of the earthworks (although this might be desirable). A potentially more significant problem relates to intersecting earthworks elements. If two earthwork elements intersect, the one lower in the calculation order will report in the area of intersection. This means you will not get double reporting of disturbance areas (2D or 3D) or volumes. However, the 'User Input' areas do not have this benefit so the areas will double report paving if two earthwork elements intersect.

**Using the Raise Element to Report Paving Volumes**

Rather than taking areas and then multiplying then by paving thickness to calculate the volume of paving, modeling the paving using earthworks elements can be beneficial. Although this method might be a bit slower than using areas reported in previous phases, it does have the advantage of resulting in the last phase of your project built up to finished level. This is useful for checking your site, as you can perform spot checks or cross sections to verify the elevations reported from the model against the site plan (site plans almost always show FFL levels).

To complete paving calculations using *Kubla Cubed's* modelling tools, a process similar to completing a topsoil strip in reverse is applied:

1. Define paving in its own phase by creating a new phase named 'Paving' or a similar designation.

2. Use 'Raise' elements with a height set to the overall thickness of paving. If 'Raise' elements overlap, they will override each other. In cases of intersection, the depth in the lower element in the calculation order takes precedence.
3. Ensure that the 'Raise' element has the 'Heights From' property set to 'Ground' (the default) if there are no absolute elements above in the calculation order. It is not recommended to change these options from the default settings or use absolute elements in a paving phase to maintain consistent behavior of 'Raise' elements overriding each other.

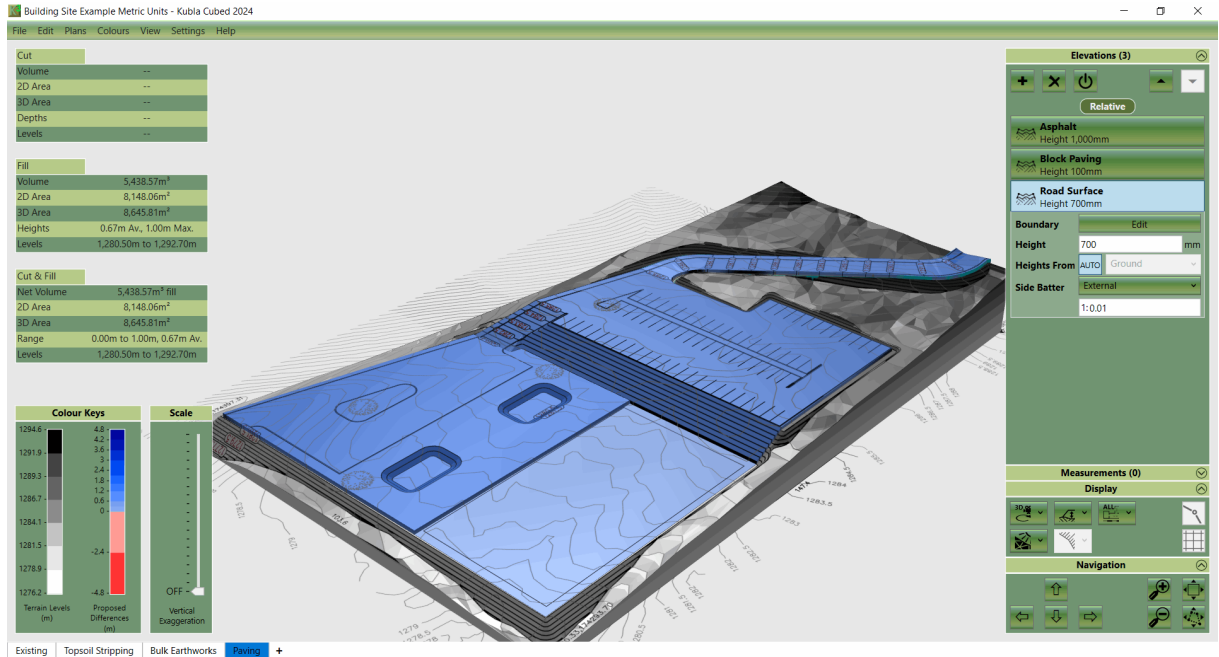

*Paving volumes calculated using 'Raise' elements, with the lower element in the calculation order taking precedence at intersections (using default settings).*

## Obtaining a Breakdown of different Paving Strata

Rarely is paving made up of a single material. For instance, a tiled area will may have layers of sand and gravel underneath for stability. A road would have even more layers. If you have an overall paving volume calculated, it is quite easy to break this down into different layers using ratios or percentages. For example, if paving is made up of 20% tile, 20% sand and 60% gravel, breaking down the overall paving volume into different materials in a spreadsheet is straightforward.

However, you can also model this also in *Kubla Cubed*. To do so, create different phases for each layer and use 'Reduce' elements with a height set to just the thickness of the strata. This method has the benefit of each material in paving having a separate volume in the exported reports and spreadsheets. It is best to have one phase per material and name the phase after the material. For many projects, this might be considered overkill given how easy it is to complete in a spreadsheet, but it is possible to do this if needed.

---

# Chapter 16

---

## Marine Dredging & Reclamation

---

### Topics:

- [Coordinates and Bathymetry](#)
- [Modelling tools](#)
- [Visualisation](#)

*Kubla Cubed* is routinely used to calculate dredging and reclamation quantities for coastal engineering projects. *Kubla Cubed* not only excels at this but also makes it extremely quick and easy to explore dredging and reclamation options at the concept design stage.

It should be noted that *Kubla Cubed* is not specialist coastal engineering software and Kubla offers a more specialised software called *Kubla Ports*. If you are heavily involved in coastal engineering, you may wish to investigate this software as well.

In this chapter, we'll discuss the coordinate system used in *Kubla Cubed* and the potential requirement to convert data before editing. There is coverage of bathymetry (measurement of depths below landform) before a focus on how different Cubed elements and settings can effectively contribute to a coastal project.

## Coordinates and Bathymetry

---

### Coordinates

*Kubla Cubed* uses a Cartesian coordinate system, either in metres (mE, mN) or feet (ftE, ftN). The coordinate system is not defined in the software, and it's up to the user to ensure that all the data they are loading is in a consistent Cartesian coordinate system.

In coastal engineering, it is common to have data in a spherical coordinate system (°E, °N). If you have such data, you will need to use other software to convert it into a Cartesian coordinate system of your choice, such as UTM, before importing into *Kubla Cubed*. If you have raster images in spherical coordinates that you want to load as site plans, you should ideally use software to skew them into your chosen Cartesian coordinate system before loading them as site plans.

### Processing Bathymetry

One of the biggest challenges with coastal engineering projects is dealing with a wide range of bathymetric data sources, from PDF contour maps to raw data from echo sounders in text files. *Kubla Cubed* can combine data from various sources, but like any ground modelling software, careful consideration needs to be given to how you define your bathymetry.

As *Kubla Cubed* is based on Triangulated Irregular Networks (TINs), it's possible to combine a range of disparate sources of bathymetry data. For example, one part of the site may have high-resolution gridded data from a bathymetric survey, while another part may only have data from contour lines traced off a PDF.

Bathymetric data as received from echo-sounding likely needs processing before being usable in *Kubla Cubed*. Processing is required to remove outliers and erroneous soundings, and also to thin the data to prevent the software from becoming slow and unusable. Bathymetric processing is a specialist task and beyond the scope of *Kubla Cubed*, so it must be done in other software before importing. Typically, the data might be gridded before being imported into *Kubla Cubed*. The grid resolution should be adequate for accuracy without being so dense that the software becomes difficult to use.

## Modelling tools

---

While land-based earthworks projects typically have contoured design levels, coastal projects tend to be somewhat simpler, involving a series of flat areas to be dredged or reclaimed. For this reason, some design elements available in *Kubla Cubed* are rarely used on coastal projects. The following two elements are typically the most useful:

- **Platforms:** Used to define flat areas by drawing the outline of the flat area. These are useful for dredging berth pockets and turning circles, for example.
- **Paths:** Used to define areas by drawing a centreline and specifying the width. These are useful for dredging channels, for example.

### Cut Only and Fill Only

One of the key differences between typical coastal engineering projects and land-based earthworks is that only cut or only fill is often specified. For example, in a dredging project, you only remove material and do not fill to the designed level. Since *Kubla Cubed* has been used for coastal engineering from the outset, this has always been an option on every earthworks element. Achieving this is simply a matter of setting the 'Mode' to 'Cut' instead of the default 'Cut & Fill'.

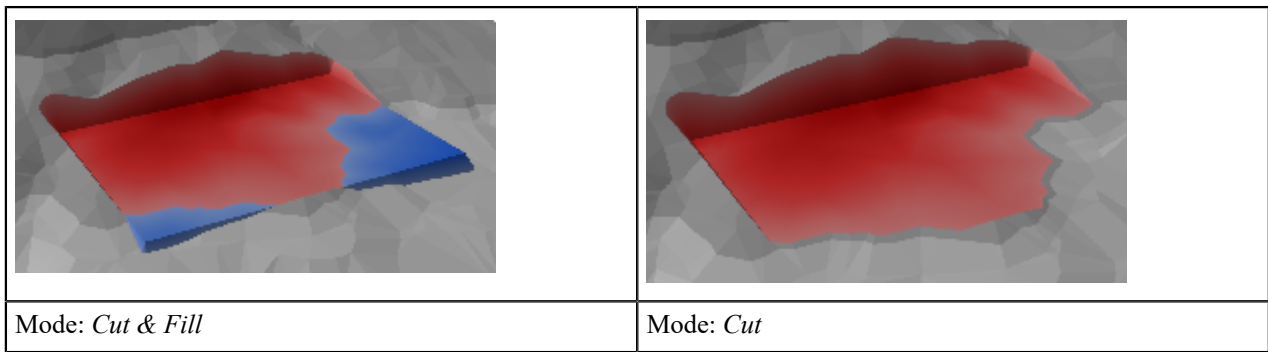

The cut-only mode, which is rarely used on land-based projects, is routinely required for coastal projects.

### Side Batters

One powerful feature of *Kubla Cubed* is the ability to automatically generate side batters to slope between the design ground levels and the existing bathymetry. This is particularly important for coastal projects, where the batter angles can be quite low, and the volumes within these batters can represent a significant part of the total volumes. See [Side Batters](#) on page 52.

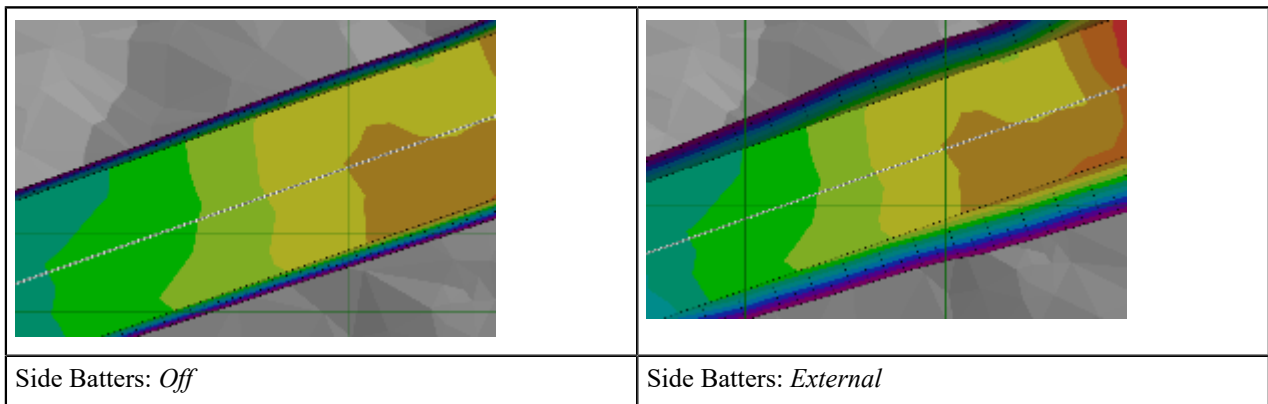

Side batters can comprise a significant part of the volumes on coastal projects. *Kubla Cubed* generates them automatically and you can adjust the batter angles as required.

## Visualisation

*Kubla Cubed* offers a range of editable effects to aid visualisation.

### Vertical Exaggeration

Due to the scale of coastal engineering projects, the variation in Z values is usually trivial compared to the size of the project. As a result, 3D visuals can appear to be almost flat. For this reason, *Kubla Cubed* allows you to exaggerate the vertical scale when you are viewing in 3D. See [Vertical Exaggeration](#) on page 28.

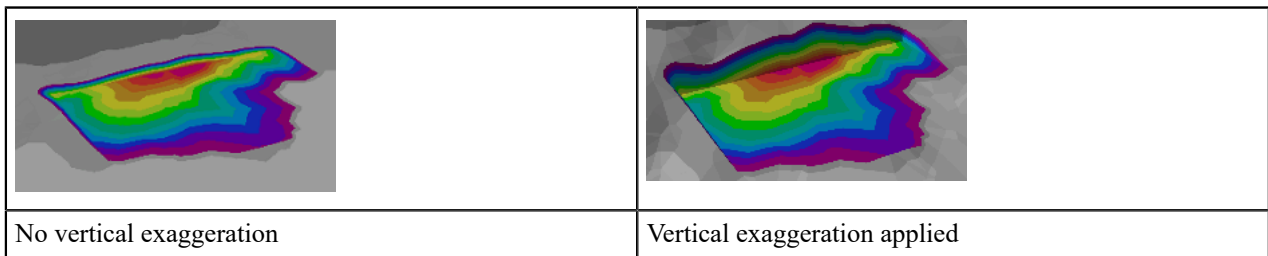

The vertical exaggeration can be increased to improve understanding of the variations in 3D topology when viewing very large projects.

## Shading Schemes

Since typical dredging projects are cut-only, as described above, the default shading scheme—which displays cut in varying shades of red, and fill in varying shades of blue—is not particularly appropriate. Commonly, dredging is displayed in a Rainbow shading scheme, which maximises the contrast in dredging depths. This is provided as a default shading scheme, but you can also customise as required.

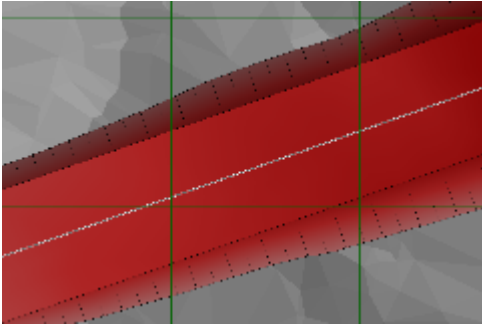
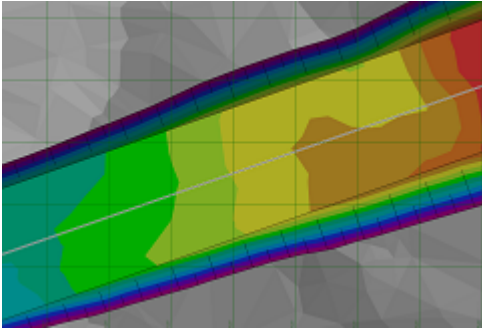
	
Default red (cut) and blue (fill) shading	Preset shading scheme 'Rainbow' applied

*Typically the rainbow shading scheme is used to display dredging depths, rather than the default red and blue.*

---

# Chapter 17

---

## Stockpile Volumes

---

### Topics:

- [Importing Survey Point File \(.CSV, .XYZ, .XLS, .UAV\)](#)
- [Calculate the Volume of the Stockpile - Platform](#)
- [Calculate the Volume of the Stockpile - Feature Surface](#)

There are various ways to calculate the volume of stockpiles, in *Kubla Cubed*. This chapter will demonstrate how to import survey data from your stockpile and then guide you on how to calculate the volume.

## Importing Survey Point File (.CSV, .XYZ, .XLS, .UAV)

With the first phase (called 'existing') selected, add a new element of the type 'Feature Surface' from the earthworks panel in the top right. This element will act as container for the data to be imported. Your survey files will contain points stored in text based format, typically .csv, .xyz, xls, or .uav (e.g. mydata.csv).

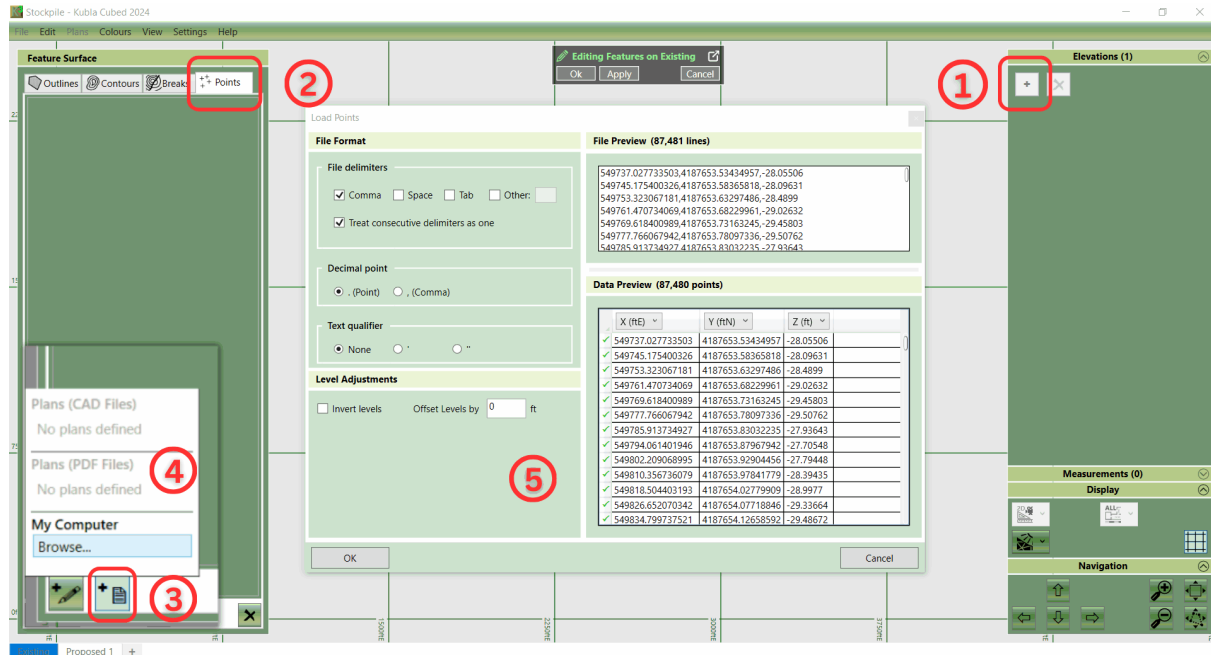

- ① Open the 'Feature Surface' for your new project.
- ② On the left-hand side, you will see a panel with four headings (Outlines, Contours, Breaks, and Points). Since you will be editing points, make sure to select the fourth tab, 'Points'.
- ③ In the bottom left corner, locate the second button, 'Add Points from Site Plan or File.' Hover your mouse above the button to view a tool-tip, ensuring you are selecting the correct option, then left-click.
- ④ Choose the file you want to import when prompted.
- ⑤ A new window will appear, allowing you to modify the file format settings. Confirm that the X, Y, Z columns in your file are correctly displayed in the table. Once satisfied, click the OK button to load the points into your project.
- To complete the process, add the boundary outline of the stockpile. Select the first tab at the top of the panel, marked 'Outlines.' Click on one of the buttons at the bottom to either create or load an outline. For creating an outline, choose between 'Automatic' and 'Draw.' Automatic will shrink-wrap the points, with the process being software-controlled. A preview with a fidelity slider is provided before completion. Drawing the outline manually is human-controlled. Alternatively, if you have a PDF or CAD file with the outline defined, import it by adding from the file, as mentioned previously.

Additionally, if your stockpile has been defined in a CAD or PDF format, then there is also the option to add points, contours and break lines from these files by selecting a sample entity of the points/lines you want to import. Go to the CAD import section for more details.

## Calculate the Volume of the Stockpile - Platform

With the existing surface now complete, you can move to the 'Proposed 1' tab to create a 'Platform' and calculate the volume. This is the recommended method when using the Lite version of the software, where the Feature Surface element is not available. For the preferred method in Kubla Cubed Professional, see the [Feature Surface](#) section.



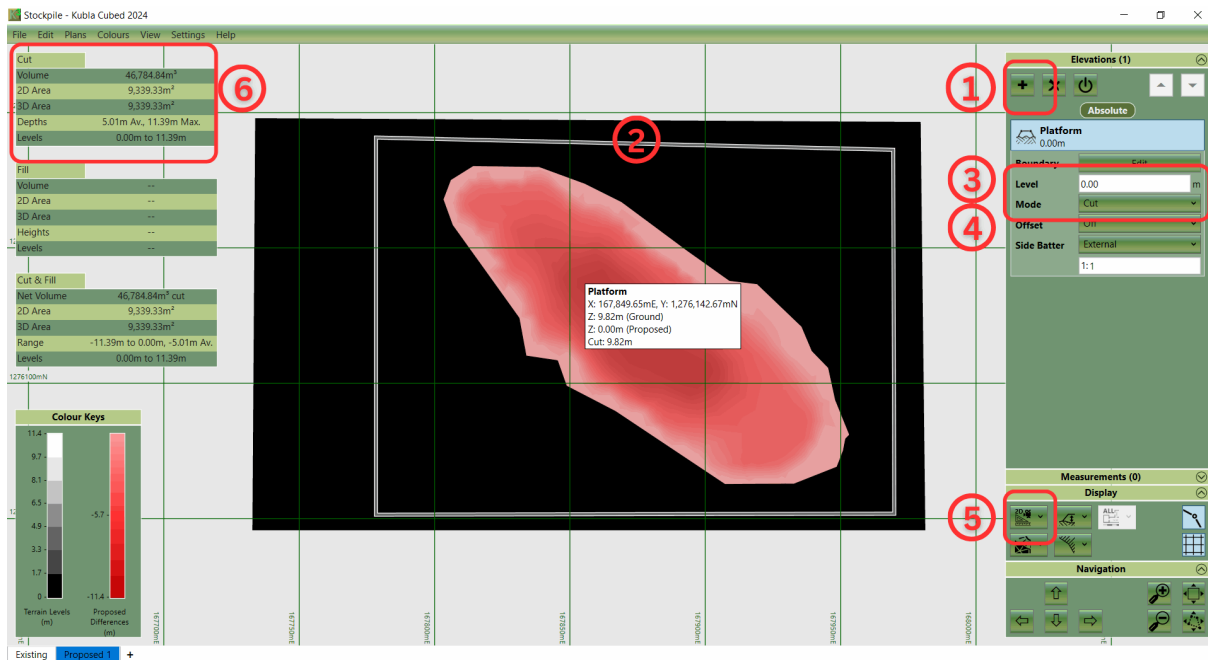

- ① Add a 'Platform' by clicking on the '+' button in the Elevations menu.
- ② Use your cursor to draw a boundary around the stockpile base, and click 'OK'.
- ③ In the 'Elevations' panel, adjust the level of 'Platform' to match the average elevation level at the stockpile base.
- ④ Change the 'Mode' to 'Cut' only.
- ⑤ Using the 'Display' panel options, observe the 2D and 3D visualisations of the stockpile cut.
- ⑥ 'Cut' volume total is displayed.

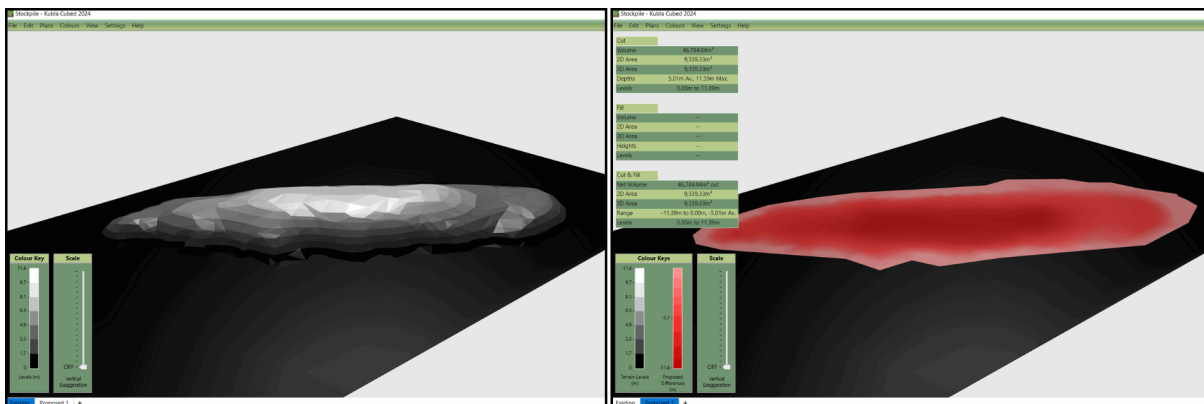

In this scenario, the survey data of the stockpile serves as the 'Existing' surface, while a flat area is designated as the 'Proposed' surface. We are instructing the program to calculate the 'cut' volume, representing the excavation needed to achieve a specified level and perimeter for the stockpile. After defining the stockpile elevations in the 'Existing' phase, they are adjusted to the Platform level. As a result, the cut volume, indicating the volume of material to be excavated from the stockpile, can be found in the top left-hand corner of the interface and in the export reports, and spreadsheets.



See how to calculate stockpile volumes in this video: [How to Calculate Stockpiles with Free Software.](#)

## Calculate the Volume of the Stockpile - Feature Surface

With the existing surface complete, proceed to the 'Proposed 1' tab to create a 'Feature Surface' to calculate the volume of your stockpile by following the steps below:

1. Add a 'Feature Surface' by clicking on the '+' button in the Elevations menu.
2. Add a new manual Outline (pencil button) → select 'Draw' → 'Define Varying Levels'
3. Use your cursor ① to draw a boundary around the stockpile base, read the Ground Z elevation shown on the cursor label ② and type into the box ③, then click 'Continue' ④ or the 'Enter' key to add a new point to the boundary.

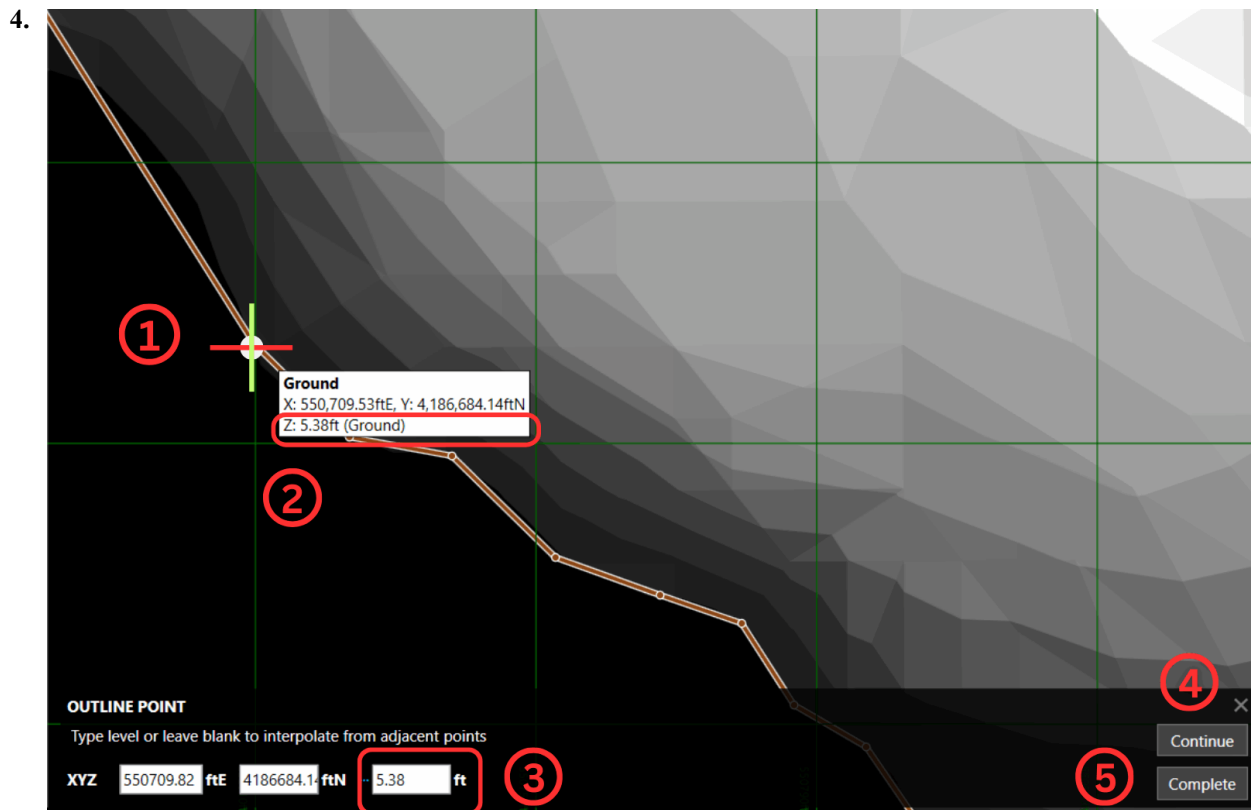

5. Once the boundary has been defined, click 'Complete' ⑤ → 'Finish' → 'OK'.
6. In the 'Elevations' panel, change the 'Mode' to 'Cut' only.
7. Adjust the side batter, as needed.
8. Using the 'Display' panel options, observe the 2D and 3D visualisations of the stockpile cut.
9. The 'Cut' volume total is displayed on the left-hand side and in the estimation spreadsheet/report exports.

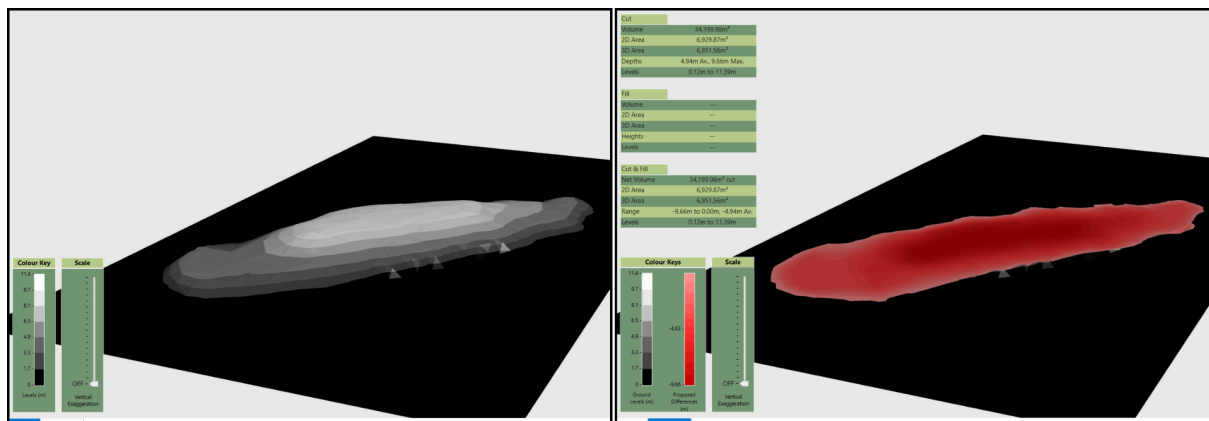

In this scenario, the survey data of the stockpile serves as the 'Existing' surface, while a flat area is designated as the 'Proposed' surface. After defining the stockpile elevations in the 'Existing' phase, they are adjusted to the Feature Surface Varying Levels Outline. The cut volume, indicating the volume of material to be excavated from the stockpile, can be found in the top left-hand corner of the interface, as well as in the export reports and spreadsheets.



---

# Chapter 18

---

## Exporting Spreadsheets & Reports

---

### Topics:

- [Creating Reports](#)
- [Creating Spreadsheets](#)

When it comes to presenting the results of a project to a client, colleague or other stake-holder, *Kubla Cubed* has a number of options available:

- **Spreadsheets:** An earthworks estimation spreadsheet can be produced that breaks down the earthworks in each phase. There are subsequent breakdowns by region, and by element. Another spreadsheet containing input data can also be produced, which is useful for validating inputs and viewing measurement information. For more information see [Creating Spreadsheets](#).
- **Reports:** An earthworks estimation report can also be produced with the same breakdown as the spreadsheet. The report contains diagrams and formatting that makes it easier to understand so is often more appropriate to give to clients than the spreadsheet. A report containing input data can also be produced for validating inputs and viewing measurement information. For more information see [Creating Reports](#).
- **Reporting in the Software:** For all phases except the first, a statistics panel will display in the top left with cut and fill data. The level of detail can be controlled from the 'Project Settings', located in the 'Settings' menu. The statistics panel will not show when an element is being edited.

Within the program the options for presenting the above data are contained within the File menu. Here you will find the Create Spreadsheet and Create Report sub menus.

## Creating Reports

To export a report click on the File menu item, then Create Report and finally Input Data or Estimation, depending on the report you wish to create. The report can be saved in the MS Word (.docx) or Adobe Acrobat (.pdf) format.

### Input Data Report

A report of the user input data, including all properties, boundary areas and perimeters. The report can be useful for validating input data and using boundary perimeter and area values in a bill of quantities (BOQ) or for doing further calculations on the data.

The report will contain the input data that has been entered by the user into the program. It contains no information regarding earthworks calculations (cut & fill); that information is contained in the earthworks estimation report. The count, area and length measurement elements will only appear in this report as they have no relevance to the earthworks estimate.

Building Site Example Metric Units (Input Data)

Paving

Elevation Elements

Asphalt	
Type	Raise Element
Height	1.00m
Mode	Cut and Fill
Side Slopes	1:0.01(Fill), 1:0.01(Cut)
Boundary 2D Area	2,292.77m <sup>2</sup>
Boundary 2D Perimeter	215.15m

Block Paving	
Type	Raise Element
Height	0.10m
Mode	Cut and Fill
Side Slopes	1:0.01(Fill), 1:0.01(Cut)
Boundary 2D Area	1,912.30m <sup>2</sup>
Boundary 2D Perimeter	178.69m

Road Surface	
Type	Raise Element
Height	0.70m
Mode	Cut and Fill
Side Slopes	1:0.01(Fill), 1:3(Cut)
Boundary 2D Area	1,519.03m <sup>2</sup>
Boundary 2D Perimeter	188.60m

Produced by Kubla Cubed, 2024 (7:0)  
Creation Date: 9 Jun 2024 (07:31:08)

Page 4 of 4

OK Cancel

**Notes on Boundary 2D Area and 2D Perimeter :** The boundary areas and boundary perimeters in the input data report relate to the element boundary lines that have been input by the user. They will often differ considerably from the areas in the earthworks estimation report which are calculated from the earthworks area of disturbance.

Volume region elements are not allowed to overlap each other. Where one volume region is inside another, the area of the internal volume region will be removed from the external one. The area and perimeters presented for volume regions in the report are the areas after they have undergone this processing.

### Estimation Report

A report of the earthworks estimations, including levels, volumes and depths can be exported to a .xlsx file. The report can be useful for building into an earthworks bill of quantities (BOQ) report or for doing further calculations on the data.

This report will contain the earthworks estimation output calculated by the program. This includes cut/fill volumes, depths and areas. The earthworks estimate is completed for all earthworks in the phase. In addition it can contain the following breakdowns.

- **Breakdown by Element:** The element breakdown will show you the cut & fill contribution of each element in a phase, based on the disturbance areas of each element. This can be very useful if different earthworks have been

represented by different elements (e.g. roads, building pads, gardens etc...). If elements intersect then consider how to attribute the cut & fill in the intersecting areas. The approach used in *Kubla Cubed* is to report the cut & fill to the element that appears lowest in the calculation order. This correlates to the way that element elevations override each other in most scenarios, the lower element takes priority.

It is important to note that the element breakdown does not calculate cut & fill between elements. In *Kubla Cubed* within each phase, all earthworks elements are combined into a single surface and cut & fill is calculated between the resulting proposed surface and the ground surface. However, multiple phases can be used if you want to calculate cut and fill between multiple surfaces. The earthworks report is helpful for viewing the breakdown by element regions, as it has a diagram above each element breakdown table.

- **Breakdown by Region:** If volume region elements exist in a phase, a breakdown by region will be completed. A region within a region will be handled by first calculating the outer region excluding the inner region and then calculating the inner region separately.

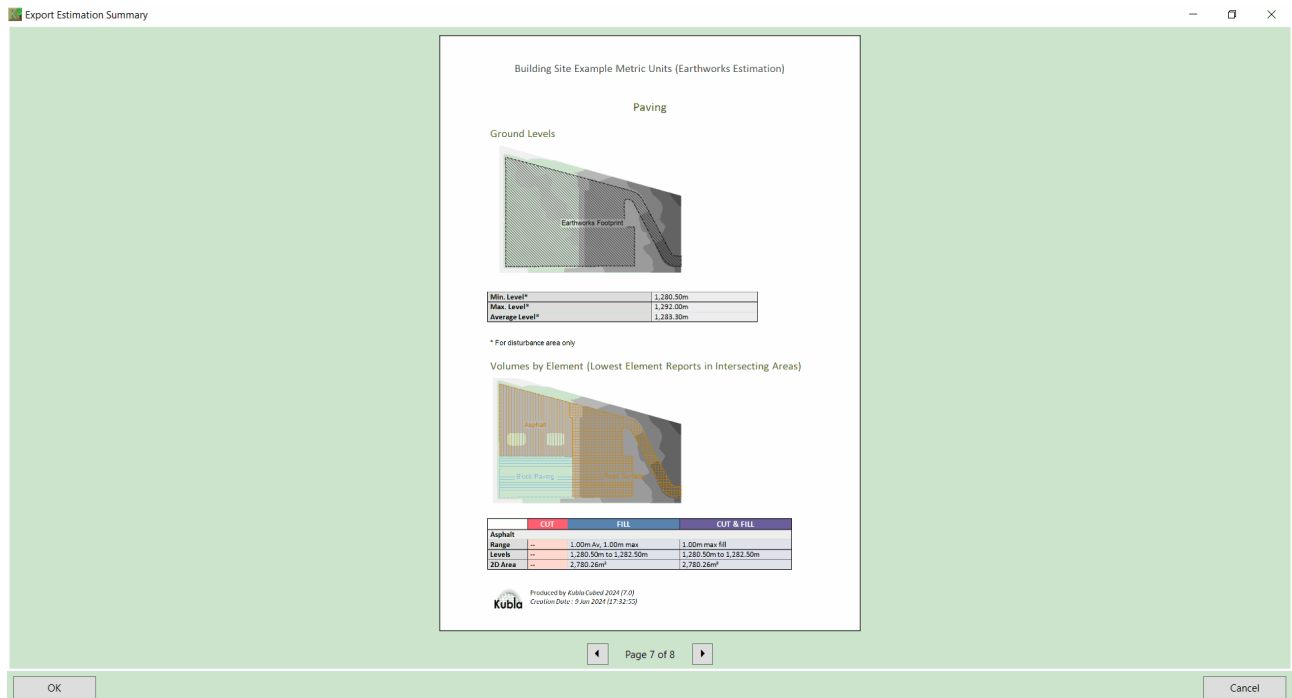

**Notes on Earthworks Estimation 2D and 3D Areas :** 2D and 3D areas in the earthwork estimation report relate to the earthworks footprint (sometimes referred to as the area of disturbance). For the area and perimeter of the element boundaries refer to the input data report. The 2D areas reported are the same as if measured from a paper plan. The 3D areas take into account the surface area of the topography and therefore will always be the same or larger than the 2D areas.



[Exports - Report & Spreadsheets](#) video describes the main sections of a typical report.

## Creating Spreadsheets

To export a spreadsheet click on the File menu item, then Create Spreadsheet, and finally Input Data or Estimation, depending on the spreadsheet you wish to create. The spreadsheet can be saved in the MS Excel (.xlsx) format.

### Input Data Spreadsheet

A spreadsheet of the user input data, including all properties, boundary areas and perimeters. The spreadsheet can be useful for validating input data and using boundary perimeter and area values in a bill of quantities (BOQ) or for doing further calculations on the data.

The spreadsheet will contain the input data that has been entered by the user into the program. It contains no information regarding earthworks calculations (cut & fill); that information is contained in the earthworks estimation spreadsheet. The count, area and length measurement elements will only appear in this report as they have no relevance to the earthworks estimate.

The screenshot shows a spreadsheet window titled 'Create User Input Spreadsheet'. The spreadsheet has columns A through J. Row 1 is a header for 'INPUT DATA'. Rows 2-7 are 'ELEVATION ELEMENTS'. Rows 8-10 are 'MEASUREMENT ELEMENTS'. Rows 11-12 contain production and creation date information. The spreadsheet is currently on a 'Proposed 2' tab.

INPUT DATA									
	Type	Level Range (ft)	Depth (ft)	Mode	Side Slopes	Boundary 2D Perimeter (ft)	Boundary 2D Area (ft <sup>2</sup> )	Feature Count	
3	Finished Levels	Feature Surface	5046 to 5067		Cut and Fill	1:1(Fill), 1:1(Cut)	1780	157450	83 Contours, 3 Break Lines, and 1 Outline
4	Material 1	Reduce		1	Cut and Fill	1:1(Fill), 1:1(Cut)	1046.71	31840.71	
5	Material 2	Reduce		0.5	Cut and Fill	1:1(Fill), 1:1(Cut)	553.56	12950.5	
6	Material 3	Reduce		0.67	Cut and Fill	1:1(Fill), 1:1(Cut)	1056.21	17058.55	
MEASUREMENT ELEMENTS									
	Type	Level Range (ft)	Depth (ft)	Mode	Side Slopes	Boundary 2D Perimeter (ft)	Boundary 2D Area (ft <sup>2</sup> )	Feature Count	
9	Count	Count						3 Items	
11	Produced by Kubla Cubed 2024 Professional (7.0)								
12	Creation Date : 3 Jan 2024 (11:39:48)								

**Notes on Boundary 2D Area and 2D Perimeter :** The boundary areas and boundary perimeters in the input data spreadsheet relate to the element boundary lines that have been input by the user. They will often differ considerably from the areas in the earthworks estimation report which are calculated from the earthworks area of disturbance.

Volume region elements are not allowed to overlap each other. Where one volume region is inside another, the area of the internal volume region will be removed from the external one. The area and perimeters presented for volume regions in the spreadsheet are the areas after they have undergone this processing.

### Estimation Spreadsheet

A spreadsheet of the earthworks estimations, including levels, volumes and depths can be exported to a .xlsx file. The spreadsheet can be useful for building into an earthworks bill of quantities (BOQ) report or for doing further calculations on the data.

This spreadsheet contains the earthworks estimation output calculated by the program. This includes cut\fill volumes, depths and areas.



Create Estimation Spreadsheet

A	B	C	D	E	F	G	H	I	J	K	L	M	N	O	P	Q
1		*Min Level (m)	*Max Level (m)	*Average Level (m)												
2	Ground Levels	170.1	170.6	170.32												
3																
4	*For disturbance area only															
5																
6																
7	<b>VOLUMES BY ELEMENT (Lowest Element Rule)</b>	<b>Depths (m)</b>	<b>Levels (m)</b>	<b>2D Area (m<sup>2</sup>)</b>	<b>3D Area (m<sup>2</sup>)</b>	<b>Volume (m<sup>3</sup>)</b>	<b>Heights (m)</b>	<b>Levels (m)</b>	<b>2D Area (m<sup>2</sup>)</b>	<b>3D Area (m<sup>2</sup>)</b>	<b>Volume (m<sup>3</sup>)</b>	<b>Range (m)</b>	<b>Levels (m)</b>	<b>2D Area (m<sup>2</sup>)</b>	<b>3D Area (m<sup>2</sup>)</b>	<b>Net Volume (m<sup>3</sup>)</b>
8	Gardens	0.18 av. 0.43 max	169.99 to 170.6	8426.47	8433.96	1555.89	0.2 av. 0.6 max	170.1 to 170.7	8753.16	8768.73	1782.74	0.43 cut to 0.6 fill	169.99 to 170.7	17179.64	17202.68	226.85
9	Building Pads	0.19 av. 0.4 max	170 to 170.6	8498.66	8823.67	1605.1	0.07 av. 0.6 max	170.1 to 170.7	6.86	324.79	0.47	0.4 cut to 0.6 fill	170 to 170.7	8505.52	9148.46	-1604.63
10	Garages	0.19 av. 0.42 max	169.97 to 170.6	1493.72	1678.29	277.52	0.09 av. 0.49 max	170.1 to 170.64	0.9	89.73	0.08	0.42 cut to 0.49 fill	169.97 to 170.64	1494.62	1768.02	-277.44
11	Shared Drives	0.1 av. 0.55 max	170 to 170.6	2618.75	2848.5	251.69	0.04 av. 0.6 max	170.1 to 170.7	935.73	1345.36	37.13	0.55 cut to 0.6 fill	170 to 170.7	3554.48	4193.86	-214.56
12	Roads	0.22 av. 0.5 max	170.1 to 170.6	9187.27	9187.27	1981.48						0.5 max cut	170.1 to 170.6	9187.27	9187.27	-1981.48
13	Footpaths	0.15 av. 0.55 max	170.05 to 170.6	7.65	765.15	1.17	0.68 av. 0.9 max	170.1 to 171	6455.88	10581.59	4400.11	0.55 cut to 0.9 fill	170.05 to 171	6463.53	11346.74	4398.94
14	Detention Pond	1.82 av. 2.6 max	167.5 to 170.1	1493.91	1644.35	2713.51	0.49 av. 0.9 max	170.1 to 171	921.38	1028.51	448.74	2.6 cut to 0.9 fill	167.5 to 171	2415.29	2672.86	-2264.77
15	Pavilion Paving	0.17 av. 0.31 max	169.95 to 170.26	372.69	402.41	63.33						0.31 max cut	169.95 to 170.26	372.69	402.41	-63.33
16	Pavilion Building	0.44 av. 0.56 max	169.7 to 170.26	693.9	723.36	303.77						0.56 max cut	169.7 to 170.26	693.9	723.36	-303.77
17	Parking Lot	0.09 av. 0.19 max	170.14 to 170.34	902.84	909.29	84.98	0.01 av. 0.04 max	170.19 to 170.23	77.7	78.08	1.15	0.19 cut to 0.04 fill	170.14 to 170.34	980.55	987.36	-83.82
18																
19	<b>VOLUMES BY REGION</b>	<b>Depths (m)</b>	<b>Levels (m)</b>	<b>2D Area (m<sup>2</sup>)</b>	<b>3D Area (m<sup>2</sup>)</b>	<b>Volume (m<sup>3</sup>)</b>	<b>Heights (m)</b>	<b>Levels (m)</b>	<b>2D Area (m<sup>2</sup>)</b>	<b>3D Area (m<sup>2</sup>)</b>	<b>Volume (m<sup>3</sup>)</b>	<b>Range (m)</b>	<b>Levels (m)</b>	<b>2D Area (m<sup>2</sup>)</b>	<b>3D Area (m<sup>2</sup>)</b>	<b>Net Volume (m<sup>3</sup>)</b>
20	NRM2 [1000mm to 500mm]Fill						0.7 av. 0.9 max	170.1 to 171	6607.32	7922.57	4607.74	0.9 max fill	170.1 to 171	6607.32	7922.57	4607.74
21	NRM2 [500mm to 50mm]Fill						0.24 av. 0.5 max	170.1 to 171	8304.7	11599.26	2009.53	0.5 max fill	170.1 to 171	8304.7	11599.26	2009.53
22	NRM2 [50mm to 0mm]Fill						0.02 av. 0.05 max	170.1 to 170.65	2239.61	2694.96	53.15	0.05 max fill	170.1 to 170.65	2239.61	2694.96	53.15
23	NRM2 [0m to 2m]Cut	0.21 av. 2 max	168.1 to 170.6	32918.05	34617.44	6870.09						2 max cut	168.1 to 170.6	32918.05	34617.44	-6870.09
24	NRM2 [2m to 4m]Cut	2.53 av. 2.6 max	167.5 to 170.1	777.82	798.8	1968.34						2.6 max cut	167.5 to 170.1	777.82	798.8	-1968.34
25																
26	<b>PHASE TOTAL VOLUMES</b>	<b>Depths (m)</b>	<b>Levels (m)</b>	<b>2D Area (m<sup>2</sup>)</b>	<b>3D Area (m<sup>2</sup>)</b>	<b>Volume (m<sup>3</sup>)</b>	<b>Heights (m)</b>	<b>Levels (m)</b>	<b>2D Area (m<sup>2</sup>)</b>	<b>3D Area (m<sup>2</sup>)</b>	<b>Volume (m<sup>3</sup>)</b>	<b>Range (m)</b>	<b>Levels (m)</b>	<b>2D Area (m<sup>2</sup>)</b>	<b>3D Area (m<sup>2</sup>)</b>	<b>Net Volume (m<sup>3</sup>)</b>
27	All Elements	0.26 av. 2.6 max	167.5 to 170.6	33695.87	35416.24	8838.43	0.39 av. 0.9 max	170.1 to 171	17151.62	22216.79	6670.42	2.6 cut to 0.9 fill	167.5 to 171	50847.49	57633.02	-2168.01
28																
29																
30	<b>LENGTHS</b>	<b>Tag</b>	<b>2D Perimeter (m)</b>	<b>2D Area (m<sup>2</sup>)</b>	<b>2D Length (m)</b>	<b>Count</b>										
31																
32																
33																
34																
35																
36																
37																
38																
39																
40																
41																
42																
43																
44																
45																
46																
47																
48																
49																
50																
51																
52																
53																
54																
55																
56																
57																
58																
59																
60																
61																
62																
63																
64																
65																
66																
67																
68																
69																
70																
71																
72																
73																
74																
75																
76																
77																
78																
79																
80																
81																
82																
83																
84																
85																
86																
87																
88																
89																
90																
91																
92																
93																
94																
95																
96																
97																
98																
99																
100																

Existing Demolition Strip Bulk Earthworks

OK Cancel

The earthworks estimate is completed for all earthworks in each phase, in addition it can contain the following breakdowns.

- Breakdown by Element:** The element breakdown will show you the cut & fill contribution of each element in a phase, based on the disturbance areas of each element. This can be very useful if different earthworks have been represented by different elements (e.g. roads, building pads, gardens etc...). If elements intersect then consider how to attribute the cut & fill in the intersecting areas. The approach used in *Kubla Cubed* is to report the cut & fill to the element that appears lowest in the calculation order. This correlates to the way that element elevations override each other in most scenarios, the lower element takes priority.

It is important to note that the element breakdown does not calculate cut & fill between elements. In *Kubla Cubed* within each phase, all earthworks elements are combined into a single surface and cut & fill is calculated between the resulting proposed surface and the ground surface. However, multiple phases can be used if you want to calculate cut and fill between multiple surfaces. The earthworks report is helpful for viewing the breakdown by element regions, as it has a diagram above each element breakdown table.

- Breakdown by Region:** If volume region elements exist in a phase, a breakdown by region will be completed. A region within a region will be handled by first calculating the outer region excluding the inner region and then calculating the inner region separately.

**Notes on Earthworks Estimation 2D and 3D Areas :** 2D and 3D areas in the earthwork estimation spreadsheet relate to the earthworks footprint (sometimes referred to as the area of disturbance). For the area and perimeter of the element boundaries refer to the input data spreadsheet. The 2D areas reported are the same as if measured from a paper plan. The 3D areas take into account the surface area of the topography and therefore will always be the same or larger than the 2D areas.

## Cross Sections Spreadsheet

A separate tab/sheet will appear for each phase. Each sheet shows sections top to bottom.

There are five column headings: *Section Name*; *Segment Number* (meaningful for long sections); *Distance* (each value is relative to the start position); *Ground Level* and *Proposed Level*.

Create Cross Sections Spreadsheet

	A	B	C	D	E	F	G	H	I
1				CROSS SECTIONS					
2	SECTION 1	Segment No	Distance (ft)	Ground Level (ft)	Proposed Level (ft)				
3	CrossSection	1	0	5045.79					
4		1	4.84	5045.81					
5		1	9.43	5045.85					
6		1	12.19	5045.87					
7		1	13.76	5045.89					
8		1	18.1	5045.94					
9		1	19.82	5045.96					
10		1	26.91	5046					
11		1	28.76	5046.03					
12		1	50.14	5046.22					
13		1	61.09	5046.45					
14		1	62.87	5046.46					
15		1	68.09	5046.49					
16		1	69.71	5046.5					
17		1	79.87	5046.77					
18		1	94.17	5047.11					
19		1	110.09	5047.5					

Proposed 1 Proposed 2 Proposed 3

OK Cancel

Blank rows separate proposed elevations from existing, which are in row separated groups to make chart creation easier. When creating a graph in your favourite spreadsheet editor, select data and headings from the last three columns. Insert a chart and ensure it is a Scatter graph. We suggest 'XY Scatter' & 'Lines Only' in LibreOffice Calc; 'Scatter' & 'Scatter with Straight Lines' in MS Office Excel.



[Exports - Report & Spreadsheets](#) video describes the main sections of a typical spreadsheet.

---

# Chapter 19

---

## Exporting Images & Drawings

---

### Topics:

- [Creating Drawings](#)
- [Export Image](#)
- [Export to LandXML](#)

When it comes to presenting the results of a project to a client, colleague or other stake-holder, *Kubla Cubed* has a number of options available:

- **Drawings:** Summary drawings can be presented of the project, showing a plan view of each phase, as well as the summary volumes and any transects that have been defined. These drawings can be exported either to a PDF file or to various CAD file formats. For more information see [Creating Drawings](#).
- **LandXML Data:** A lot of the project data can be exported to this specialist land surveying file format. LandXML is a popular data transfer format used to import/export line-work, survey points and surfaces. Like the CAD data, LandXML can also be used to import data into machine control systems. For more information see [Exporting LandXml Data](#).
- **Images:** Images showing the design area can be exported to a several file formats. The images can display the shaded terrain and earthworks, and can optionally include grid lines, colour keys and contour lines. For more information see [Creating Images](#).

Within the program the options for presenting the above data are contained within the File menu. Here you will find the Create Spreadsheet, Create Report and Create Drawing sub menus. For CAD Data and LandXML Data use the Export menu.

## Creating Drawings

The project data in *Kubla Cubed* can be presented as drawings, which can be saved either as PDF or to various CAD file formats. These drawings will include plan views of each phase you export, along with colour keys, earthworks quantity summary tables and transects if you have defined any.

To create a drawing, click on File, Create Drawing, and then PDF or CAD.

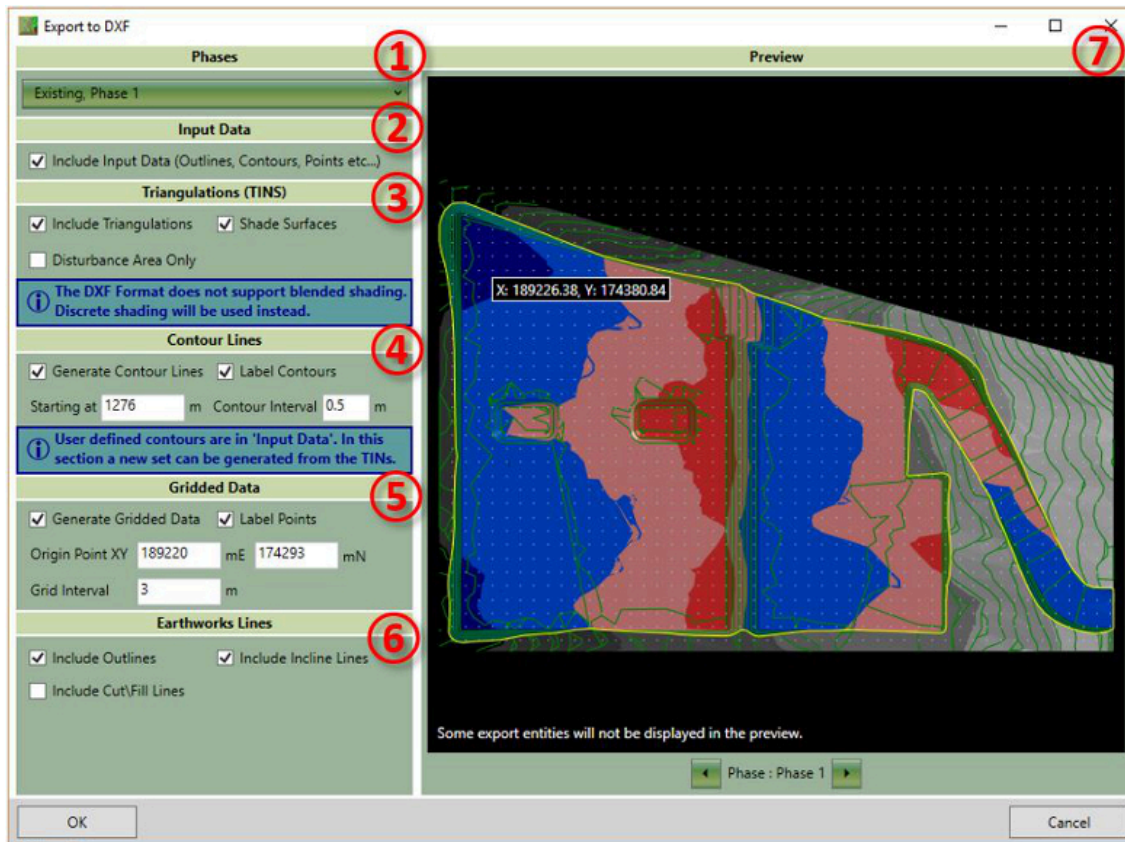

The available options on this form are described below:

- ① The Phases drop-down allows you to select which phases to include in the drawings. By default, only the selected phase and the existing phase are included. File layers are used to separate the entities by phase.
- ② Input Data: Select whether the drawings should include the user-input data (contours, points, boundaries etc.).
- ③ Triangulations: Select whether to include the TINS in the drawings. Often, the TINS are not required if you are just interested in a contour line or gridded data visualisation.
  - Disturbance Area Only In some scenarios when exporting proposed surfaces, you may not want the undisturbed ground in the drawings.
- ④ Contour Lines: Choose to generate surface contour lines. Note that contour lines used to define 'Feature Surfaces' in *Kubla Cubed* will be included if 'Input Data' is checked. These are not the contour lines referred to in this section. The contour lines in this section are an entirely new set that are generated from the entire proposed surface.
  - Label Contours: You can choose to turn off the labeling of contour lines.
  - Starting At: In this box, set the level the contour lines start. It is advised to start on a round number. The default will be set to the bottom of the surface rounded down.
  - Contour Interval: In this box, set the interval distance between each contour line. Very small contour intervals can cause large export times and large file sizes.

- ⑤ As well as generating contour lines from the TINS, you can also include gridded data. This feature can be used to create a cut\fill plan for site engineers or present results to those accustomed to using the grid method for calculations.
  - Label Points: Choose to turn off the labelling of points as it saves space in the file. It is recommended you keep this on, as the points will have little meaning otherwise.
  - Origin Point: Set the location of the origin point. The grid will extend out from here in all directions until it exceeds the extents of the surface. It is recommended to use rounded numbers. By default, it is set to the bottom left, rounded to a whole number.
  - Grid Interval: In this box you can set the distance between each grid point. Very small grid intervals can cause large drawing generation times and large file sizes.
- ⑥ Earthworks linework created by *Kubla Cubed* can also be included in the drawings.
  - Outlines: The outlines of the earthworks can be included, which can be useful for knowing the location of designed features such as building pads, roads, ponds etc.
  - Incline Lines: *Kubla Cubed* generates 'incline lines' to mark the generated side slopes joining earthworks elements to the ground. You can choose to include these in the drawings.
  - Cut\Fill Lines: The lines can be exported in red and blue, showing the earthworks cut\fill boundaries.
- ⑦ Use the preview to get an indication of the drawing file's content. It is especially useful for previewing the density of the generated gridded data and generated contour lines. Note that this is only a preview, and your drawings will not appear exactly as presented here. When multiple phases are selected, you can cycle through them for preview using controls at the bottom of the preview panel. Multiple phases are not previewed all together to avoid confusion.

Once the drawing settings have been finalised, click OK. You will be prompted to choose the location to save your drawings.

## Export Image

---

Images showing the design area can be exported to several file formats, including .bmp, .jpg, and .png. These images can display the shaded terrain and platforms, and can optionally include grid lines, colour keys and contour lines.

To export an image, click on File, Create Drawing and then Image. The export window will appear, like the one shown below.

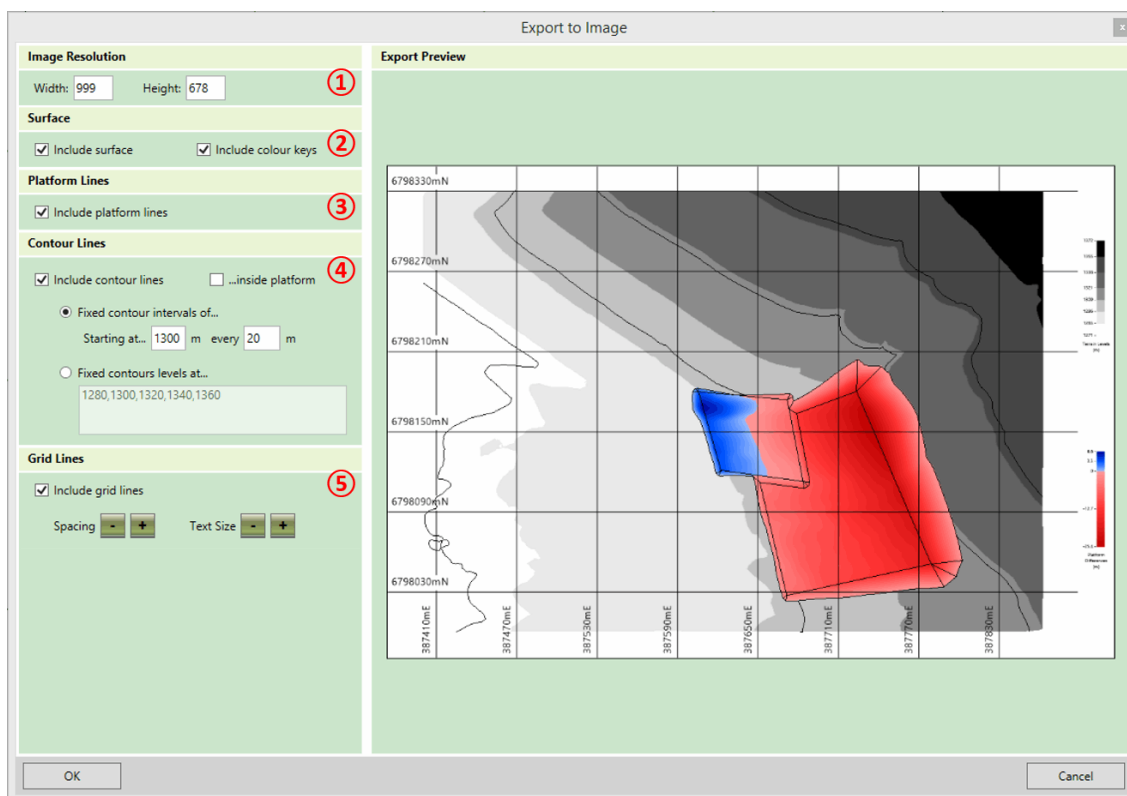

The export options on this form are described below:

- ① Image Resolution: Higher quality images than the resolution can be obtained by increasing the resolution, but it will take longer to generate the image and the file size will be larger. Note that the aspect ratio of the export image is fixed, so adjusting either the width or the height will update the other dimensions automatically.
- ② Surface: You can indicate whether or not you want to include the shaded surfaces in your export. If included, you can also choose whether or not to include colour keys beside the image. If you choose to include surfaces then the shading in the export will be the same as in the main window.
- ③ Platform Lines: Indicate whether or not the platform slope lines should be included in the image export.
- ④ Contour lines: Define options. In the first two checkboxes, you can indicate whether you want to include contour lines in the export image. If included, you can choose whether or not contour lines should be shown inside the platforms; otherwise they will only be shown on the existing terrain. If contour lines are to be drawn, you must also specify which level the lines should be drawn at, using one of the following methods:
  - Fixed Contour Intervals of... If this option is selected, contour lines will be shown with fixed intervals (e.g. every 20m). You can also specify a level to start the contour lines from. Use this to ensure a contour line is drawn at a particular level, such as 0m. Note that contour lines will be drawn both above and below this starting line at the specified interval to cover all of the ground.
  - Fixed Contour Levels at... If this option is selected, the levels of each contour line can be specified by typing into the box, allowing for contour lines to be drawn at irregular intervals. Contour level values which are typed must be separated by a comma.
- ⑤ Grid Lines: In the first check box specify whether or not you want grid lines to be included. If grid lines are to be included, then the grid line spacing and the text size for grid lines can be increased or reduced by clicking on the + and - buttons.

Once the export settings have been finalised, click OK. You will be prompted for the location to save the export file and the file format to save.

**Notes on 3D View Images :** The image export can only produce images in the design view. To export an image of the project in one of the 3D views it is best to use the Windows Snipping Tool after putting the program into Presentation Mode. Within the program, switch to one of the 3D views and navigate to the position you want. Then, from the Display menu, select Presentation Mode. Use the windows snipping tool to take a screen capture of the area that you



want and then exit presentation mode by hitting the Esc key. For instruction on how to use the Snipping Tool, refer to [Windows Support: Use Snipping Tool](#) to capture screenshots.



Image export customisations are discussed in our [Exports - Images](#) video, with a demonstration of capturing 3D views using the Windows Snipping Tool [later in the video](#).

## Export to LandXML

The project data in *Kubla Cubed* can be exported to LandXML. LandXML is a widely supported format used for transferring engineering and surveying data between different programs. Many specialist software applications can import/export this format, visit [www.landxml.org](http://www.landxml.org) for an extensive list of software that can import/export LandXML. LandXML is the recommended method for transferring TINS between *Kubla Cubed* and other programs.

When developing workflows for use with machine control systems it is sometimes necessary to use LandXML and CAD exports in tandem. Typically, LandXML for the TINS and CAD for the linework.

To export project data to LandXML click on File, Export and then LandXML. The LandXML export window will appear as shown below.



The available options on this form are described below:

- ① The phases drop-down allows you to select which phases are exported to LandXML. By default, only the selected phase is exported. Unlike CAD, LandXML does not have a layer system so it is advantages to only export the data you need to avoid the confusion of having a long list of objects that aren't required.

- ② In this section you select whether the export should include the data that the user has input into the project (contours, points boundaries etc...). For many workflows this information is somewhat redundant and only the TINs are needed, however it can be useful in other design programs.
- ③ In this section you can choose whether to include the TINs in the export. TINs are the best way of transferring surfaces from *Kubla Cubed* to another program so you should usually keep this option checked.

**Disturbance Area Only** In some scenarios when exporting proposed surfaces, you will not want the undisturbed ground in the model. If for instance you were exporting a surface for use in another cut/fill analysis you would only want the elevations in the disturbance area only.

- ④ In this section you can choose to generate surface contour lines. Be aware that contour lines that have been used to define 'Feature Surfaces' in *Kubla Cubed* will be included if 'Input Data' is checked and are not the contour lines referred to in this section. The contour lines in this section are an entirely new set that can be generated from the entire proposed surface.
  - **Starting At** In this box you can set what level the contour lines start at, it is advised to start on a round number. The default will be set to the bottom of the surface rounded down.
  - **Contour Interval** In this box you can set the interval distance between each contour line. Very small contour intervals can cause large export times and large file sizes.
- ⑤ As well as generating contour lines from the TINs you can also export gridded data. This can be useful for importing into other programs that do not support TIN import. It also can be used to create a cut/fill plan for site engineers.
  - **Origin Point** In this box you can set the location of the origin point. The grid will extend out from here in all directions until it exceeds the extents of the surface. It is recommended that rounded numbers are used. By default, it is set to the bottom left rounded to a whole number.
  - **Grid Interval** In this box you can set the distance between each grid point. Very small grid intervals can cause large export times and large file sizes.
- ⑥ Earthworks linework created by *Kubla Cubed* can also be included in the LandXML format.
  - **Outlines** -The outlines of the earthworks can be exported, this can be useful for knowing the location of designed features such as building pads, roads, ponds etc...
  - **Incline Lines** - *Kubla Cubed* generates 'incline lines' to mark the generated side slopes joining earthworks elements to the ground. You can choose to include these in the file.
  - **Cut/Fill Lines** - The lines can be exported in red and blue which show the earthworks cut/fill boundaries.
- ⑦ The preview can be used to give a good indication of what the exported file will contain. It is especially useful for previewing the density of the generated gridded data and generated contour lines. Please note that not all entities will show in the preview. When multiple phases are selected for export you can cycle through which phase to preview using controls that will appear at the bottom of the preview panel. Multiple phases are not previewed at together to avoid confusion.

Once the export settings have been finalised click OK. You will be prompted for the location to save the LandXML file.



The [Working with LandXML Files \(.xml\)](#) video begins by importing existing and proposed surfaces from LandXML using Triangle Surfaces. It then explores options for exporting a *Kubla Cubed* project to a LandXML file.

---



---

# Chapter 20

---

## Export to CAD

---

**Topics:**

- [CAD Export Options](#)

This section explores the process of exporting project data from *Kubla Cubed* to a CAD (.dwg, .dxf) file, offering a comprehensive guide for CAD technicians and those integrating data into machine control systems.

The chapter covers the export options available and details the steps involved in the export process, including considerations for phase selection, input data inclusion, TINS, and various export settings.

## CAD Export Options

The project data in *Kubla Cubed* can be exported to an CAD (.dwg, .dxf) file. These are a widely supported formats used for transferring engineering and surveying data between different CAD programs. Using the data exported from *Kubla Cubed* a CAD technician can produce PDF files of the data for distribution or combine with other CAD data of the site to create complex drawings. For example, the gridded data could be overlaid on the original site plan to produce a detailed visualisation of the cut/fill.

When developing work-flows for use with machine control systems it is sometimes necessary to use LandXML and CAD exports in tandem. Typically, LandXML for the TINS and CAD for the linework.

To export project data to CAD, click on File, Export and then CAD Data. The CAD export window will appear as shown below.

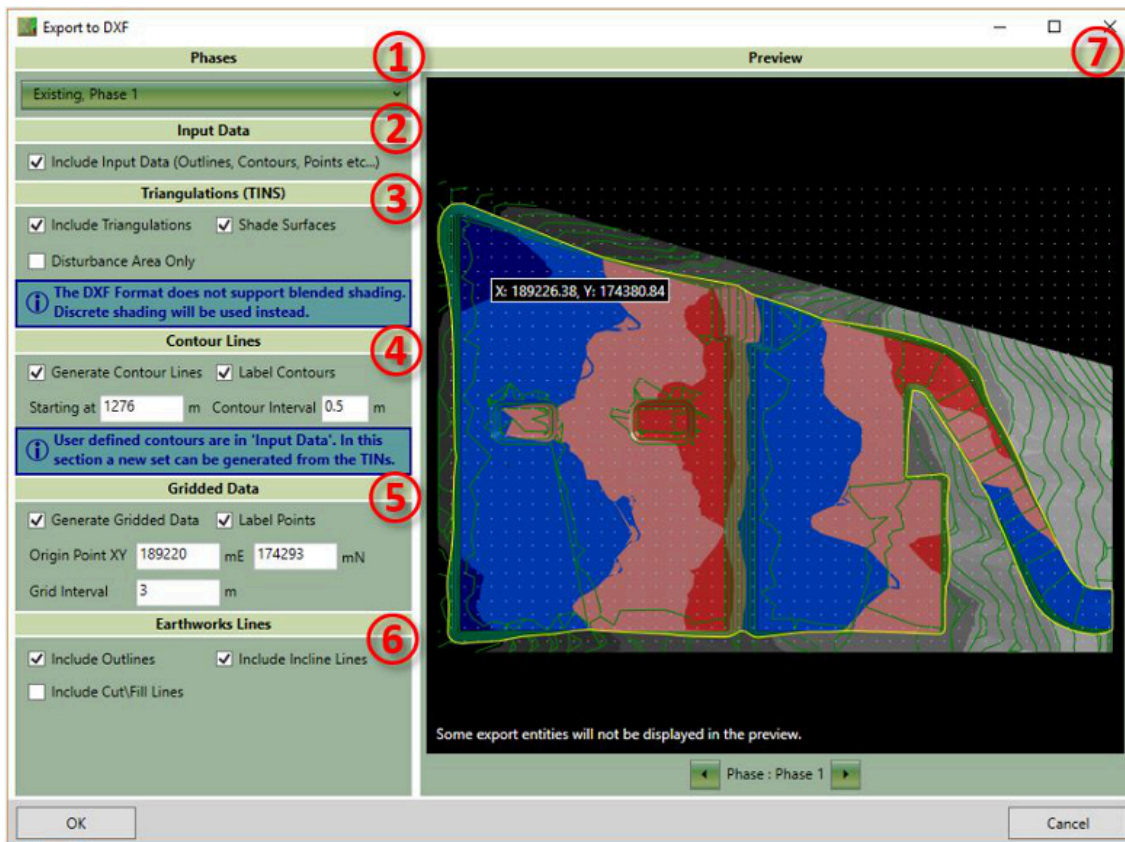

The available options on this form are described below:

- ① The phases drop-down allows you to select which phases are exported to CAD. By default, only the selected phase and the existing phase is exported. In the file layers are used to separate the entities by phase.
- ② In this section you select whether the export should include the data that the user has input into the project (contours, points boundaries etc...).
- ③ In this section you can choose whether to include the TINS in the export. Often the TINS are not required if you are just interested in a contour line or gridded data visualisation.
  - Disturbance Area Only - In some scenarios when exporting proposed surfaces, you will not want the undisturbed ground in the model. If for instance you were exporting a surface for use in another cut/fill analysis you would only want the elevations in the disturbance area only.
- ④ In this section you can choose to generate surface contour lines. Be aware that contour lines that have been used to define 'Feature Surfaces' in *Kubla Cubed* will be included if 'Input Data' is checked and are not the contour

lines referred to in this section. The contour lines in this section are an entirely new set that can be generated from the entire proposed surface.

- Label Contours - You can choose to turn off the labelling of contour lines, however as CAD has a special entity for this exact scenario it is recommended it is left turned on.
- Starting At - In this box you can set what level the contour lines start at, it is advised to start on a round number. The default will be set to the bottom of the surface rounded down.
- Contour Interval - In this box you can set the interval distance between each contour line. Very small contour intervals can cause large export times and large file sizes.
- ⑤ As well as generating contour lines from the TINS, you can also export gridded data. This can be useful for importing into other programs that do not support TIN import. It also can be used to create a cut\fill plan for site engineers.
  - Label Points - You can choose to turn off the labelling of points as it saves space in the file. Be aware that points without labels will only be useful as an import into other programs, gridded points with no labels in a CAD drawing would have little meaning.
  - Origin Point - In this box you can set the location of the origin point. The grid will extend out from here in all directions until it exceeds the extents of the surface. It is recommended that rounded numbers are used. By default, it is set to the bottom left rounded to a whole number.
  - Grid Interval - In this box you can set the distance between each grid point. Very small grid intervals can cause large export times and large file sizes.
- ⑥ Earthworks linework created by *Kubla Cubed* can also be included in the CAD export.
  - Outlines - The outlines of the earthworks can be exported, this can be useful for knowing the location of designed features such as building pads, roads, ponds etc...
  - Incline Lines - *Kubla Cubed* generates 'incline lines' to mark the generated side slopes joining earthworks elements to the ground. You can choose to include these in the file.
  - Cut\Fill Lines - The lines can be exported in red and blue which show the earthworks cut\fill boundaries.
- ⑦ The preview can be used to give a good indication of what the exported file will contain. It is especially useful for previewing the density of the generated gridded data and generated contour lines. Please note that not all entities will show in the preview. When multiple phases are selected for export you can cycle through which phase to preview using controls that will appear at the bottom of the preview panel. Multiple phases are not previewed all together to avoid confusion.

Once the export settings have been finalised click OK. You will be prompted for the location to save the DXF file.



The [Exports - CAD Files](#) video demonstrates the options for customising CAD exports.

---



---

# Chapter 21

---

## Export to BIM and/or Machine Control

---

### Topics:

- [Exporting for BIM Software](#)
- [Exporting for Machine Control Systems](#)

BIM stands for Building Information Modelling and is intended to make the construction process more efficient by recording data regarding a building's construction and ongoing maintenance. Efforts are also underway to establish open standards so widespread sharing of this data is possible between stake holders. *Kubla Cubed* cannot export directly to a BIM format (e.g IFC); however, the topography and positional data produced in *Kubla Cubed* can be exported and then imported into those systems.

Machine Control systems consist of hardware and software that is installed on earthmoving equipment that can give the operator a visual guide on where to excavate, both in 2D and 3D. Like BIM, *Kubla Cubed* cannot export directly to the propriety formats used on the systems of various manufacturers. However, it can export data that can then be imported into the software provided by the manufacturers for create machine control files.

In this chapter, we will explore some of the options for exporting *Kubla Cubed* data to BIM and Machine Control.

## Exporting for BIM Software

Most BIM systems support the import of data using CAD files (e.g. .dwg, .dxf), so this is the best option for importing linework, such as earthworks definition boundaries, measurement positions, lengths and areas. You can do this by selecting **File** from the menu bar and then **Export** → **CAD Data**.

However, when it comes to the topography, things get a bit more complicated. *Kubla Cubed* uses TINS for calculating and storing topography. If a BIM program also supports TINS, it is the preferred method of importing data. However, some BIM systems do not support TIN. In such cases, they might accept points from the TIN but not the triangle data, resulting in changes to the imported surface. In situations where a BIM software does not support TIN, you can export the surfaces as either a high-density point cloud or contour lines.

To do this, select the following options from **File** → **Export** → **CAD Data** screen to generate gridded points for integration into the BIM system. The image below shows which options to choose.

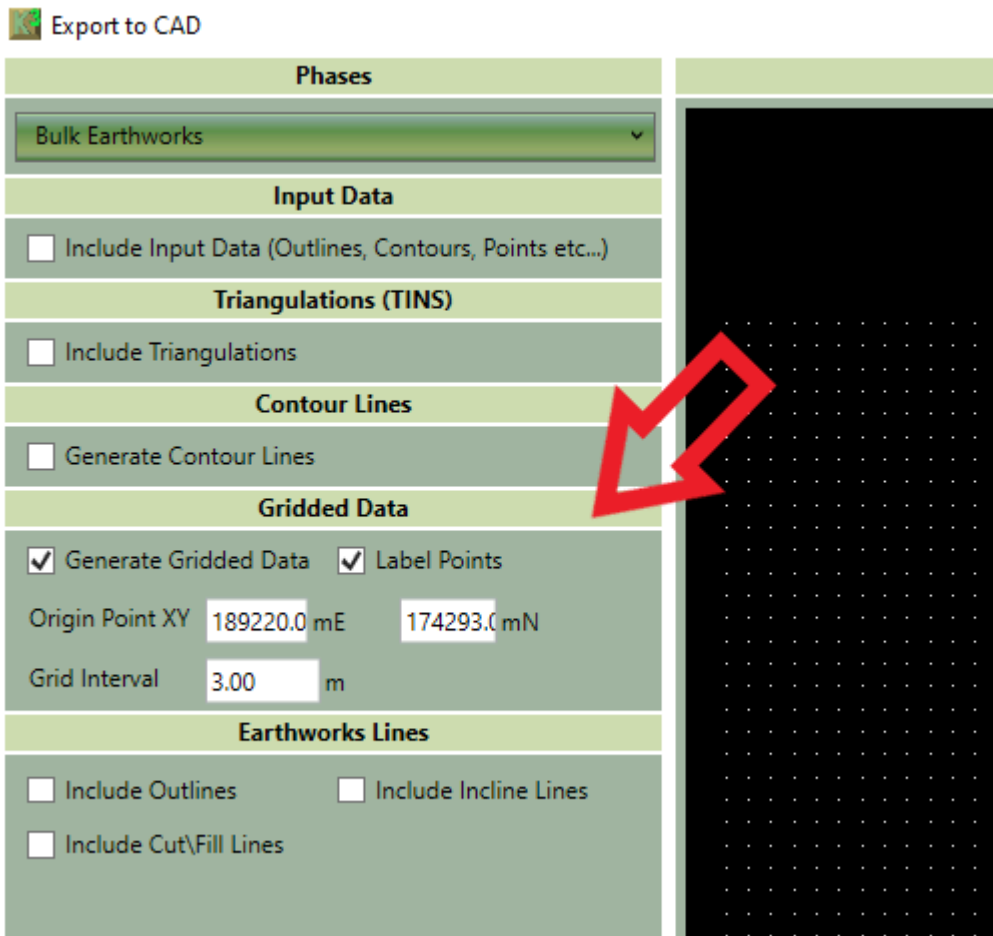

## Exporting for Machine Control Systems

Each producer of machine control systems provides their own software for preparing a file that can be uploaded to earthmoving machinery. Many of these software products support the import of both CAD (.dwg, .dxf) and Land XML (.xml) files. Therefore, you can export all your data to either of those formats, and it should import seamlessly.

To do this, navigate to:

**File** → **Export** → **CAD Data**

or

**File → Export → Land XML**

Sometimes, machine control systems work better with one format over another. It has been suggested CAD files work better for line work, while Land XML files for TINS. However, it is easier to stick to one file format unless there problems arise.

It's worth noting, some older machine control systems may not support TINS but do support point clouds. In such cases, you will need to generate gridded data in the same way as suggested for BIM Software that does not support TIN.





---

# Chapter

# 22

---

## Troubleshooting

---

### Topics:

- [Essential Project Checks](#)
- [Software Performance](#)
- [Error Messages in Kubla Cubed](#)

The troubleshooting section offers both quick tips and a more detailed explanation of how validation works in *Kubla Cubed*. This chapter aims to assist you in finding to common problems on your own.

Within the troubleshooting section, you'll also find information about the error and warning messages you might encounter. For instance, if your intention is to model a site spanning 300 metres, a warning would be triggered, if you accidentally set the site size to 300 millimetres!

## Essential Project Checks

### Project Checks

A computer model can only be as good as the data input to it. A frequently used industry phrase is 'GIGO' (Garbage In Garbage Out). Therefore, checking your input is essential to ensure that no mistakes have been made during the various stages of the project. The checks should be made after the data is input (e.g., check the site plan after it has been imported). However, we also recommended the following checks are done at the end of each project before producing reports...

**Table 1: Scale Check**

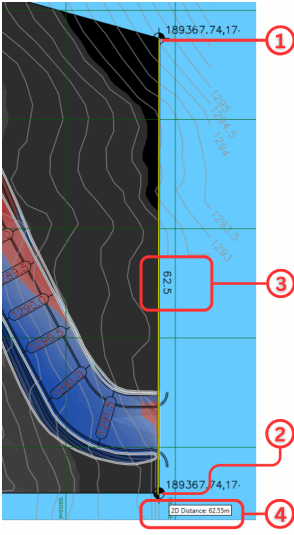
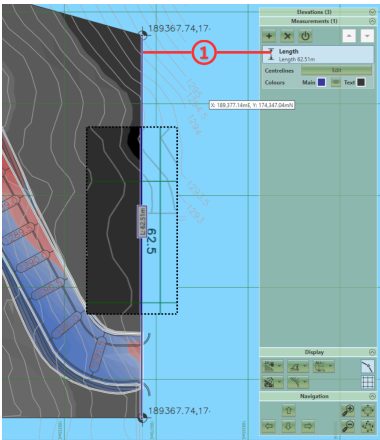
	<p>Verify that dimensions on the site plan are correct. Press and hold the 'M' key on your keyboard, then drag your mouse from the starting point ① to the endpoint ② over a known length ③. If the value ④ matches that on the site plan, then you have scaled correctly. Be sure to pick a considerable length for comparison to eliminate the possibility of small inaccuracies going un-noticed.</p>
	<p>Alternatively, you can use the 'Length' Measurement element ①. Locate this element by double clicking on the 'Measurements' panel in the right-hand side of the program. For detailed instructions, see our <a href="#">Count, Length and Area Measurements</a> video. The added benefit of this method is that the element remains in place and can be referenced each time new site plan edits are made, helping ensure nothing goes unnoticed or becomes 'broken'.</p>

**Table 2: Vertical Exaggeration Check**

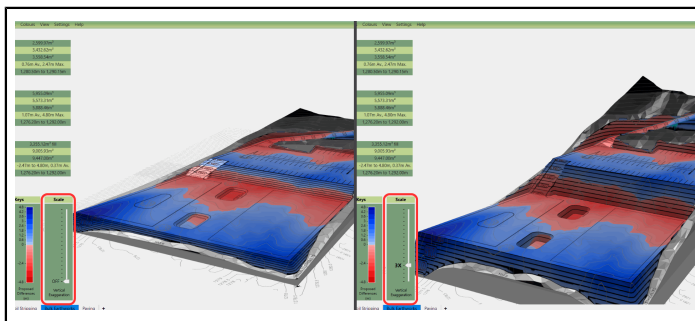

To help identify incorrect Z values and to a lesser extent, XY values, exaggerate the terrain height. Switch to one of the 3D cameras to show the [Vertical Exaggeration Tool](#). Move the tool's slider up/down to highlight obvious mistakes such as height spikes.

**Table 3: Elevation Spot Check**

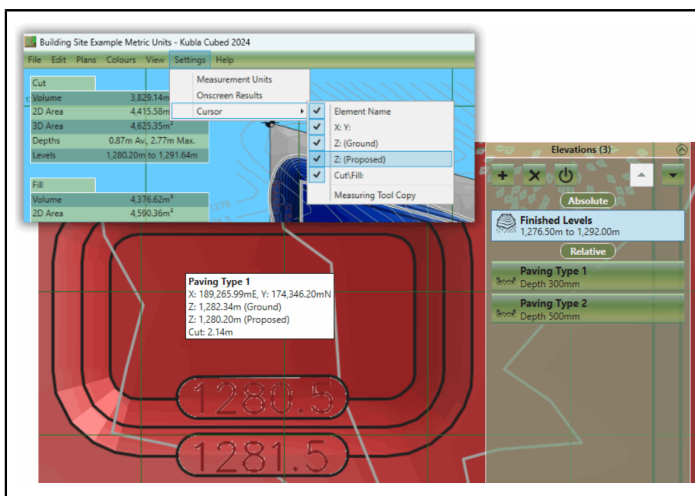

Going back to check each point's height individually would be a laborious effort. However, you can streamline the process by changing the cursor options to display the XYZ values and then mousing over the desired points. To do this, go to the menu, select 'Settings'. Within the sub menu 'Cursor', select the options X: Y: and then Z: (Proposed) and/or Z: (Ground). Now, when you hover your mouse over terrain, the selected dimension values will show the status beneath the cursor.

**Table 4: Elevation Cross Section Check**

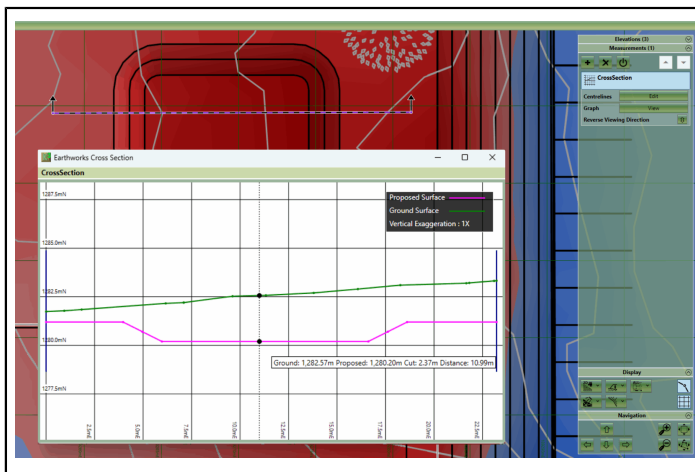

[Draw a cross-section](#) line across key areas of your site. View each section's graph within *Kubla Cubed* and examine where the proposed line rises above and falls below the existing. By moving the mouse across the graph, you can also check individual sections are precisely as expected under the cursor.

**Table 5: Cut & Fill Range and Levels Check**

Cut & Fill	
Net Volume	3,355.12m <sup>3</sup> fill
2D Area	9,005.93m <sup>2</sup>
3D Area	9,447.00m <sup>2</sup>
Range	-2.47m to 4.80m, 0.37m Av.
Levels	1,276.20m to 1,292.00m

To help check for incorrect Z values refer to the on-screen **Results Panel**, located on the left-hand side. In the Cut & Fill table, examine the Range and Levels to ensure they align with your expectations. This can highlight any errors and you can then revisit your input data to make necessary corrections.

**Table 6: Input Validation Check**

ELEVATION ELEMENTS		Type	Level Range (m)	Depth (m)	Mode	Side Slopes	Boundary 2D Perimeter (m)	Boundary 2D Area (m <sup>2</sup> )	Feature Count
1	Finished Levels	Feature Surface	5046 to 5067		Cut and Fill	1:1(FH), 1:1(CV)	17789	151450	83 Contours, 3 Break Lines, and 1 Outline
2	Material 1	Reduce		1	Cut and Fill	1:1(FH), 1:1(CV)	15462.71	11440.71	
3	Material 2	Reduce		0.5	Cut and Fill	1:1(FH), 1:1(CV)	1255.55	1255.55	
4	Material 3	Reduce		0.67	Cut and Fill	1:1(FH), 1:1(CV)	1056.21	17058.55	

Once all your data has been input, navigate to the main menu, select 'File' -> 'Create Spreadsheet', and then choose 'Input Data'. Verify that the Spreadsheet's content matches your original input data. For example, if using the offset method, offsets are all set to a minus value. Also, check the level range of each element and height/depth values.

## Software Performance

In cases where you encounter delays in software performance, this section offers suggestions to enhance speed.

### Enable/Disable

Projects with many elevation and measurement elements can cause a delay when defining new elements. One method to speed up this process is to use disable elements that are not currently being edited. This can be achieved by selecting an element/multiple elements then clicking the Power button. This approach is particularly effective if you have added Volume Regions to your project. See [The Measurements Panel](#) on page 66.

Remember to re-enable elements by clicking the power button again, once you have finished editing/adding new elements. This will then recalculate the project and it will report all the estimation volumes and measurements.

### Turn Site Plan Off

Hiding site plans or turning them off can offer some resolution to a delay. See [Setting Visibility](#) on page 40 for more details.

### Export Phase as TIN and Import as Triangle Surface

When a feature surface contains a lot of data (points, contours, breaklines), it can cause a lag in the project. You can reduce this delay by following these steps:

1. File → Export → CAD Data
2. Phases = e.g., Existing
3. Tick 'Include Triangulations'; all other sections must be unticked.
4. If exporting a Proposed phase, tick 'Disturbance Area Only'.

5. Click OK → save your renamed file to your specified location.
6. In the Existing Phase: Delete the Feature Surface
7. In the Existing Phase: Add → Triangle Surface. See [Existing Defined with Triangles](#) on page 101.
8. Browse to find the exported TIN file → Select → click OK
9. Left-click on the surface to load → click OK
10. The surface will load and display in the project. If a Proposed phase, set Side Batters to 'Off'.

## Error Messages in Kubla Cubed

All software encounters error messages from time to time and *Kubla Cubed* is no different. In this chapter, we discuss the 'Calculation Error' message, which may occur when working on complex projects. We also discuss *Kubla Cubed*'s calculation steps and the error reporting features. This section discusses quite advanced topics and is intended for experienced users.

### Overview

Calculation error messages in *Kubla Cubed* are displayed when the calculations fail, or where a validation step fails. Validation steps are run at numerous points during the calculation to ensure the integrity of the final result. No calculation engine is going to be entirely error-free, especially one whose calculations are based on Triangular Prisms, as in *Kubla Cubed*. This method is the most accurate, but is also far, far more technically challenging than the grid and cross-section methods that are used by some other earthworks software.

*Kubla Cubed* offers users the flexibility to create as many phases of work as they wish, with each phase containing an unlimited number of earthworks elements. While this flexibility is advantageous, it also allows for very complex projects to be defined, increasing the likelihood of calculation errors compared to more restrictive software.

### Calculation Steps

To understand the sources of calculation errors, it is helpful to understand the steps involved in the calculation. We will briefly summarise the process below. These steps are repeated for each phase in the project.

For each earthworks element in a phase, there is a three-step process:

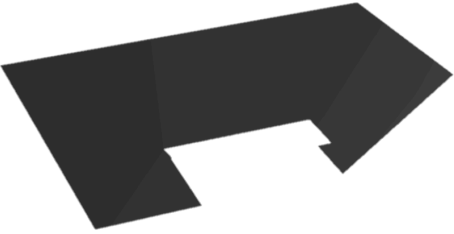
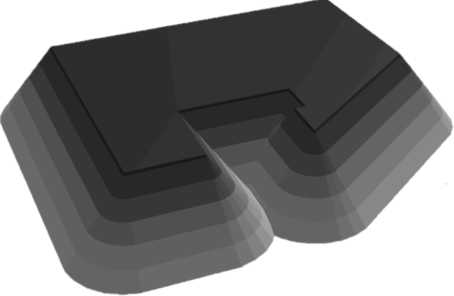
<p><b>Step One : Generating the surface mesh.</b></p> <p>For a platform, this is trivial and unlikely to cause an error. However, it is potentially quite complicated for a feature surface with many ground features. It can also be challenging for a strip or overlay, where the ground below is complex.</p>	
<p><b>Step Two : Generating batter slopes.</b></p> <p>Batter slopes are the side slopes that will be used to connect the surface mesh to the terrain. The complexity of this process depends largely on the complexity of the element's outline. However, if the batters are set to vertical (0.01) this step is quite straightforward for the software to complete.</p>	

**Step Three : Merging the element with the terrain.**

This is usually a fairly challenging step for the software, particularly if the existing and/or proposed meshes are complex.

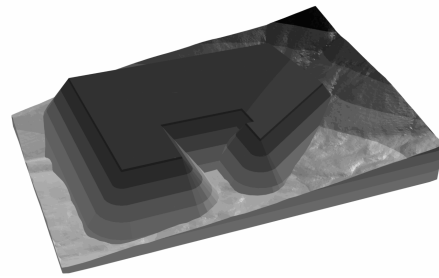

Once all of the earthworks elements have been processed in this way, two meshes will exist: the mesh at the start of the phase and the mesh after all the elements have been merged into it. The final step is to project the initial mesh edges onto the final mesh. This will create a mesh which contains all the edges of both the initial and the final meshes. This ‘Calculation Mesh’ is crucial to generate volumes and to present cut and fill maps. However, this final step of the process is extremely complex and commonly a source of error messages.

If an error occurs when merging an earthworks element into the terrain, the software will identify the element that caused the error. However, if an error occurs during the generation of the calculation mesh, it is not possible to identify a specific element that has caused the problem. For this reason, these errors can be particularly difficult for our customers to resolve with the current error messages.

**General Approach**

At Kubla, we use the following approaches to minimise the frequency and impact of calculation errors:

- Thorough validation of user-input data. This minimises the likelihood of situations that may lead to errors.
- Continual improvement to make the calculations as robust as possible. Our developers are constantly working through calculation errors reported by users; fixes are included in regular software updates.
- Presenting error details to the user about errors when they occur, to empower them to resolve the issues independently.
- Directly supporting customers who run into calculation errors.

⚠ There are issues in your data which cannot be resolved. Please review these below and press cancel to return and correct them.

Problem	Items	Resolution
<b>Outlines are overlapping</b>	📍 (0) 📍 (1)	This conflict cannot be resolved. Please press cancel and correct it in the main window.
<b>Lines intersect at different levels</b> 1 intersection, intersection level difference: 5.00m	📍 (0) 📍 (1) Intersects with...	Cannot resolve this conflict. Press cancel to resolve in the designer window.
<b>Points are identical</b>	📍 (11) 📍 (12)	All points will be removed except for

We believe that our validation, calculations and support are amongst the best available in the industry, although we continue to improve these areas. However, user feedback has indicated that error messages can be difficult to interpret and do not always provide enough information for them to find a solution on their own. For this reason, the latest release of the software includes work to improve this aspect of the software. This work is ongoing and will continue in subsequent updates.

The validator in *Kubla Cubed* aims to prevent errors in the terrain definition. It will block blatant errors, such as contour lines crossing each other with different levels. It will also warn the user about likely errors, such as one elevation which is very different from all of the others.

**Improvements to Error Reporting**

In earlier versions of the software, only one error message could be displayed to the user. This provided limited ability for our developers to communicate the source of the error to the user of the software. A significant upgrade to error reporting now presents the full error path to the user, allowing for more detailed information about the error.

However, the most notable improvement to error reporting is the capability to display the region where the error has occurred on the screen. This empowers our users to inspect the problematic area, and see if they have made any

mistake, or if they could simplify the way they have defined the ground levels in this area. Sometimes, even just moving some features in this area by a negligible amount may cause errors to go away.

However, it's essential to understand, that due to the complexity of the calculations, it's not always obvious where they have initially gone wrong. The displayed error regions will sometimes represent a 'best guess' of the location of the error source. The project should be checked in the vicinity of the identified error region, as well as within the region itself. It should also be noted that it is not possible to identify an error region for every type of error, and it will not always be displayed. However, the most common errors will now have error regions, and coverage will be expanded to more error types in the future.

